



November 30, 2023

## Shared Services Update

"Maximizing efficiency throughout the Utah System of Higher Education by identifying and establishing administrative shared services" was among the charges the Utah Legislature gave to the newly combined system upon its creation in 2020. In response, USHE engaged with Huron Consulting Group to explore, identify, and assess opportunities for creating common system-level processes and improved shared services in the context of institutional mission and culture.

Huron completed its study in 2022, initially identifying about 50 potential shared service areas and ultimately narrowing it to seven business-cased initiatives recommended for final consideration. The report also provides a framework for the goals, strategies, and core enablers of shared services.

Goals	Strategies for Success	Core Enablers
Increase Efficiency	Technology Enablement	System Governance
Risk Mitigation	Process Improvement	Policy Standardization
Financial Sustainability	Policy Standardization	Technology Consistency
		Process Redesign

### Shared Services Initiative Guiding Principles

In September 2022, the previous Board adopted eight shared services guiding principles:

1. Shared Services is a Board initiative to respond to the Utah Legislature's mandate to find ways to streamline the costs embedded in our System to improve efficiencies while improving service.
2. The sovereignty of the 16 colleges will be maintained throughout the System. The Shared Services initiative's purpose is not to "merge institutions" in any way but to find ways to streamline and improve service and reduce costs. The role and missions of institutions will not change.
3. Shared Services should result in quality improvements, risk mitigation, financial sustainability, and efficiencies, which can be measured in some way. All recommendations must include not just a cost mitigation analysis but a service enhancement as well. We want to improve service while eliminating redundancies and duplications throughout the System.

4. The Huron Shared Services Study identifies opportunities within and across institutions. The Board expects to implement some system-wide shared services. Alignments will take place at individual institutions, regionally, and at the system level. Institutions should focus on collaborations among institutions that yield the greatest impacts in terms of efficiency and quality while still strengthening our System.
5. Regionally-implemented shared services should follow a unified approach, i.e., implementation should use consistent methodologies and standards across regions.
6. Shared Services implementation should be responsive and connected to the Huron study objectives and opportunities.
7. Prioritization and implementation of shared services will be informed by service experts; we will provide consultation opportunities with subject matter experts in the areas of human resources or IT, for example.
8. Best practices will be shared & celebrated by the Board and the System.

### **Current and Prospective Shared Services Initiatives**

Enacted through Senate Bill 146 from the 2023 General Session, Utah Code section 53B-1-402 newly requires the Utah Board of Higher Education to prioritize the following areas for shared services implementation:

1. Commercialization;
2. Services for compliance with Title IX;
3. Information technology services; and
4. Human resources, payroll, and benefits administration.

Below are summaries of existing and proposed shared services operations in these four legislatively prioritized domains.

#### **Commercialization**

Current Shared Services: The Innovation District at the Point serves to establish a collaborative ecosystem that connects higher education, government, and industry, with a specific focus on commercialization and economic development for the state. Through the Associate Commissioner of Innovation, USHE is leveraging this partnership to advance shared commercialization initiatives with the Utah Innovation Lab, Utah Policy Innovation Lab, and future-constructed Convergence Hall. USHE recently launched numerous centrally coordinated innovation-related internship programs that offer students from all institutions exposure opportunities at the Utah Innovation Lab, Utah Policy Innovation Lab, and directly with private corporation research arms.

Proposed Shared Services: As Innovation District activities and operations ramp up in general, shared services in the commercialization space will naturally accelerate and scale as well. Specifically, the Innovation District has submitted a 2024 general session request for appropriation in the amount of \$500,000 in ongoing funding to resource a shared service commercialization hub, which will provide expertise and infrastructure support for institutions that lack operational backing for commercialization projects. This integrated approach ensures that all colleges, schools, innovation districts, and technology hubs can maximize available support and propel economic growth and technological advancement in a cost-efficient way.

#### Services for Compliance with Title IX

Current Shared Services: Southern Utah University and Southwest Technical College currently share Title IX investigators, hearing officers, advisors, and other resources, as well as collaborate on the development and dissemination of trainings and other educational materials. In early 2023, OCHE convened a workgroup of institutional general counsel and Title IX coordinators to explore options for expanding system-wide Title IX resources. Beyond leveraging opportunities for shared Title IX services through partnerships between degree-granting institutions and technical colleges, the workgroup also recommended bolstering Title IX resources for technical colleges in particular.

Proposed Shared Services: The UBHE recommended FY 2024-2025 budget includes a request for \$255,600 in new ongoing funding to support an additional full-time Attorney General dedicated to the system's technical colleges. This additional attorney will help to increase response time and counsel capacity, including for Title IX issues, for the technical college system.

#### Information Technology Services

Current Shared Services: The University of Utah Information Technology Department (UIT) coordinates the information technology services of all 16 USHE institutions. The chief information officers (CIOs) of all institutions meet regularly with UIT for training, to share best practices, coordinate policy development, discuss threats and opportunities, and problem-solve current IT challenges. UIT coordinates group purchasing to get the best prices on expensive IT equipment and coordinates the purchase of numerous software products for use across institutions. UIT works with institutions on a regular basis to perform cybersecurity penetration testing to understand better where security improvements are necessary. UIT routinely evaluates and pursues new system-level shared service opportunities for security and procurement.

Proposed Shared Services: The Utah Education and Telehealth Network (UETN) intends to pursue a 2024 general session request for appropriation in the amount of \$6,900,000 in ongoing funding to support cybersecurity staffing, tools, and resources for public and higher education in Utah. UETN would use this funding to implement phase one of its Unified Education Cybersecurity plan. Phase one of this plan involves purchasing basic security tools and operationalizing security personnel for collective use and

benefit of K-12 local education agencies and USHE institutions. UETN's cybersecurity plan is informed by its work with the Utah Cyber Center in relation to responsibilities to the Utah Cybersecurity Commission.

During this past year, UIT also led an effort to search for a replacement for Northstar, the student information system used by seven of the technical colleges. After much research and several presentations by various software companies, the recommendation was made to continue to invest in Northstar and to update the legacy software platform to an up-to-date, cloud-based platform. A budget request for \$1,500,000 in one-time funds has been submitted to support this initiative.

#### Human Resources, Payroll, and Benefits Administration

**Current Shared Services:** The Utah Higher Education Personnel Administrators Committee (UHEPAC), made up of human resource professionals from each of the USHE institutions, has met to explore areas where shared services may be a benefit. During this past year, that group joined together to obtain group pricing on salary survey reports from the College and University Professional Association for Human Resources (CUPA-HR). UHEPAC is looking at other information that may be obtained through group pricing. They are also exploring if it is feasible to use common vendors for such things as drug screening and background checks.

**Proposed Shared Services:** USHE institutions currently use six different health benefit carriers with varying costs, coverage, and contract negotiation processes. Increased system-level health benefit-related efficiencies may be possible by centralizing USHE institution health benefit negotiation, procurement, and administration. OCHE intends to issue a request for proposal to assess solutions for shared services in this area.

USHE technical colleges use diverse and unstandardized payroll processing systems. Payroll at the eight technical colleges is processed using five different payroll systems. Some systems are outsourced systems that provide services such as processing employee payments and filing taxes. Other systems only process payroll and payments, leaving tax filing to be done by the institution. Establishing a common vendor to provide payroll processing services for USHE technical colleges could result in increased efficiencies. Combining payroll processing for more than one institution could make various benefits, particularly retirement plan options, available to employees at smaller institutions who do not currently have the plan options that are available at larger institutions. OCHE intends to issue a request for proposal to assess solutions for shared services in this area.

#### **Other Shared Services Initiatives**

##### Bookstore Operations

USHE institutional bookstores belong to various bookstore management support organizations. These Utah organizations meet regularly for training, to share best practices, and to problem-solve bookstore concerns. One area they have spent considerable time coordinating in recent years is the adoption of

digital textbooks on campuses. These bookstore organizations have been a great source of reliable information to the various institutions as they adopt increasingly more digital instructional content.

### Internal Audit

OCHE has centralized audit functions, including providing internal audit services for technical colleges and IT audit services for Southern Utah University, Utah Tech University, Salt Lake Community College, and Snow College.

### Utah Academic Library Consortium (UALC)

The Utah Academic Library Consortium (UALC) is the cooperative organization for academic libraries in the state of Utah. With legislative support, they work collectively to share resources and provide equitable access to high-quality and cost-effective information resources, research infrastructure, and support services.

### Other Institutional and Regional Initiatives

USHE institutions have been working on institutional and regional initiatives to improve administrative services and to partner with other institutions in their region to make cost-effective and efficiency-driven improvements.

### **Commissioner's Recommendation**

The Commissioner recommends the Board support and approve the proposed expansion of shared services in the areas of commercialization, Title IX, information technology, and benefits/payroll.

### **Attachments**



# Phase 2 Report

## USHE Shared Services Study



January 5<sup>th</sup>, 2022

[huronconsultinggroup.com](http://huronconsultinggroup.com)

---

# Agenda

1. Executive Summary
2. Menu of Opportunities
3. Organizational Risk & Readiness Assessment (ORRA)
4. Next Steps

# 1

---

## Executive Summary

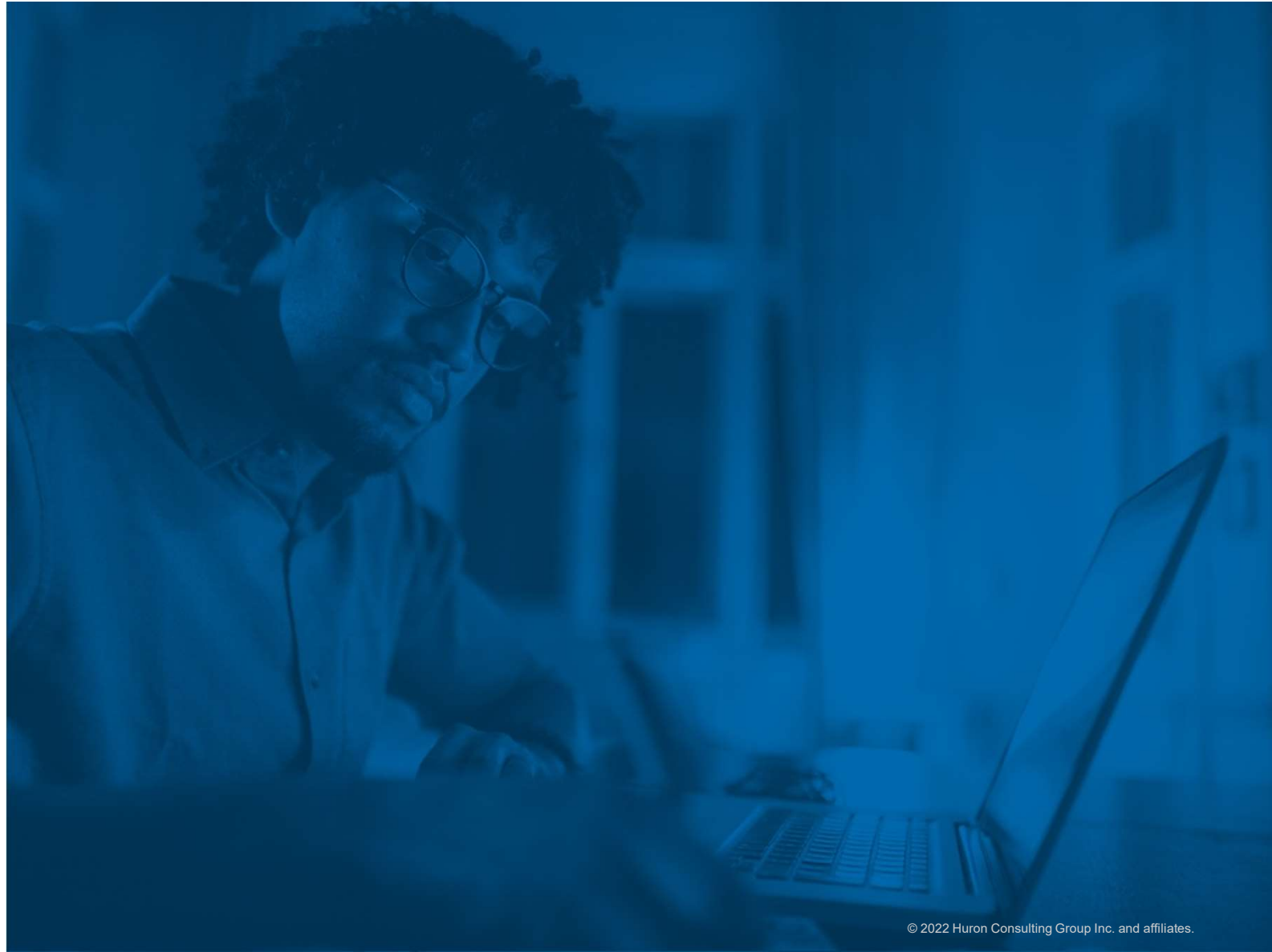



# USHE Shared Services Study Goals

The subsequent analyses and opportunities are grounded in the Shared Services Study's goals, which USHE has purposefully defined as extending beyond cost reduction opportunities.

## GOALS

### INCREASE EFFICIENCY

Identify opportunities to enhance the effectiveness, speed, or quality of service delivery to create more direct and intentional resource use.

### RISK MITIGATION

Identify opportunities to create structured compliance and minimize risk exposure to increase security in a challenged environment.

### FINANCIAL SUSTAINABILITY

Identify opportunities to stabilize resource use, decrease costs, and improve overall financial stability.

## STRATEGIES FOR SUCCESS

### TECHNOLOGY ENABLEMENT

Updated and automated processes increase trust in data and decrease manual effort, which results in greater efficiency and increased capacity.

### PROCESS IMPROVEMENT

Minimizing outdated and redundant processes will increase efficiency and allow institutions to focus on more mission-driven activity.

### POLICY STANDARDIZATION

Standardization of processes and policies ensures compliance and minimizes the risks that can arise in a more distributed operating setting.

# Phase 1 Overview

During Phase 1, the project team collected information through interviews and various data survey tools and found operational inefficiencies that can be addressed through shared services.

**Scale: Administrative support is inconsistent.**

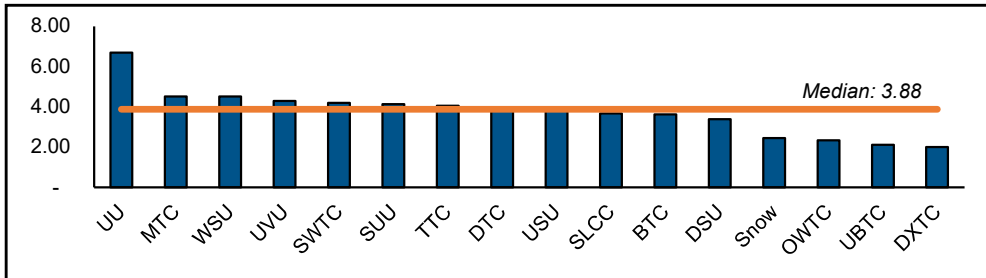

**Distribution: Administrative services are often decentralized.**

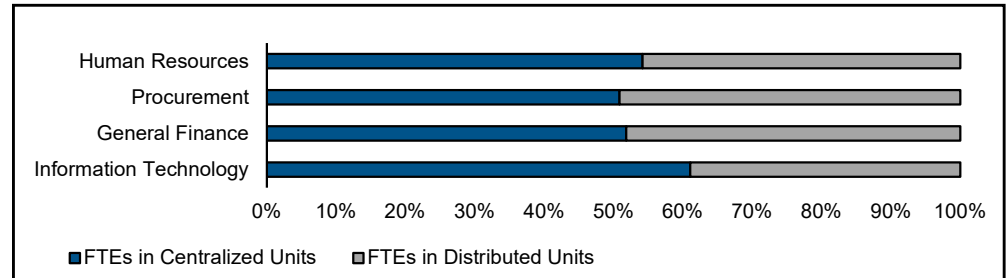

**Operating Profiles: Institutions have unique operating profiles.**

Institution Type	General Finance	HR	IT	Procurement
<b>Total Four-Year FTE</b>	<b>630.5</b>	<b>378.6</b>	<b>905.1</b>	<b>402.3</b>
Range	8.5 – 338.1	7.7- 191.2	11.3 – 501.9	5.7 – 190.3
<b>Total Two-Year FTE</b>	<b>71.4</b>	<b>46.4</b>	<b>52.7</b>	<b>41.9</b>
Range	1.0 – 41.1	1.4 – 31.2	1.6 – 22.5	1.0 – 23.4
<b>TOTAL FTE</b>	<b>701.9</b>	<b>425.0</b>	<b>957.8</b>	<b>444.2</b>

**Fragmentation: Job duties are fragmented and inconsistent.**

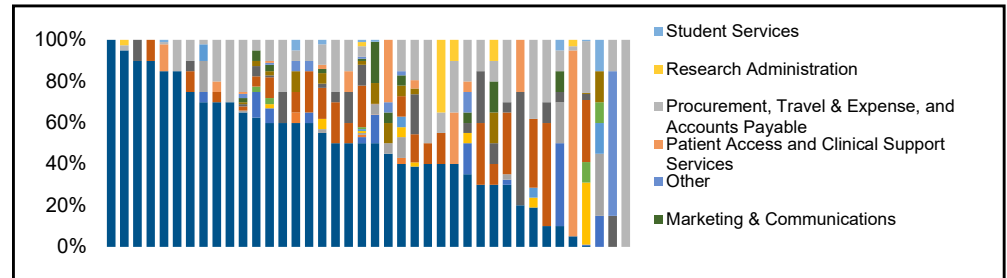

Note: For additional detail and sources regarding the information on this slide, please refer to the Phase 1 presentation, included in appendix B.

---

## Meeting Objectives

This report provides a detailed identification of opportunities accompanied by supporting analysis, project context, and discussion of next steps.

### **In this meeting we will:**

- Present opportunities identified at the local, group, and system level for the four in-scope areas (human resources, finance, procurement, information technology)
- Facilitate a discussion on change readiness in the context of these opportunities and gain perspective on what obstacles and elements may impact implementation consideration
- Establish next steps and Phase 3 activities, which include more detailed cost benefit analysis of select opportunities

# Opportunity Development

The opportunities presented in this report were developed through the synthesis of both qualitative and quantitative analysis and grounded by consistent stakeholder engagement.

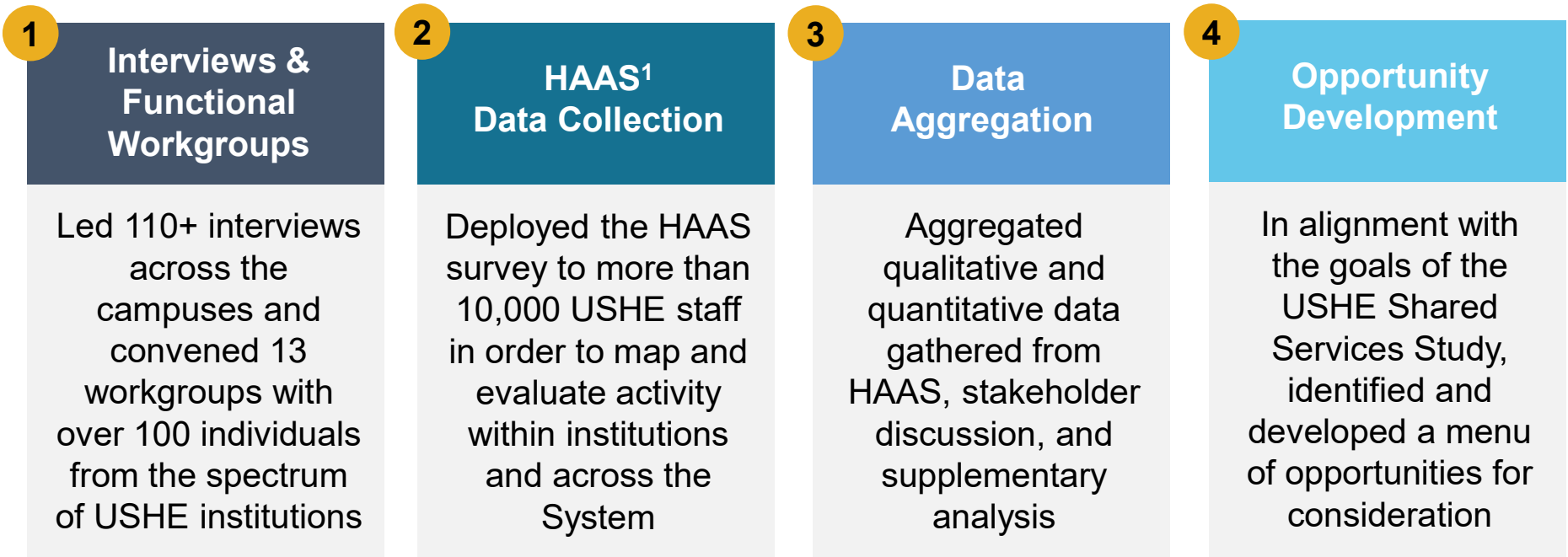

Note: <sup>1</sup>HAAS or the Huron Administrative Activity Study is a survey tool that captures employee administrative effort across a population

# Scale of Opportunities

Huron identified opportunities at varying levels of the USHE organizations, which have been categorized as local-level, group-level, and/or systemwide.

## LOCAL



- The opportunity is institution-specific and does not require action outside of a singular institution
- Local opportunities lessen barriers to change in comparison to multi-institutional initiatives
- Local opportunities can potentially be at odds with group or system opportunities depending on their focus

## GROUP



- The opportunity involves two or more institutions but does not comprise the entire system
- Group opportunities can leverage the similarities between a subset of institutions that may not be present across all 16
- Group opportunities may create resistance as some, but not all, institutions undergo change

## SYSTEM



- The opportunity involves all 16 USHE institutions and is implemented systemwide
- System opportunities present the highest potential for widespread financial and operational improvement
- System opportunities will require substantial pre-work, whether technological or operational, prior to implementation

# Foundations of 'System' Opportunities

Achieving efficiencies of scale at the System level will often require harmonizing, simplifying, and creating interoperability with data structures, policies, practices, and supporting technologies.

## Core Enablers of Systemwide Collaboration

### DATA STRUCTURES

- Chart of Accounts
- Job Classifications
- Job Actions/Reasons
- Salary Structures
- Earnings Types/Codes

### POLICY & PRACTICE

- Administrative Calendars
- Time and Leave
- Pay Schedules
- Salary Structures
- Benefit Structures
- Governance & Oversight

### TECHNOLOGY

- Reporting & Business Intelligence
- Case & Service Management
- Data Warehouses
- ERP & Ancillary Systems

# Categorization of Opportunities

Opportunities will then fall into one of five categories that help to frame the fundamental goal of each initiative and what kind of change is required.

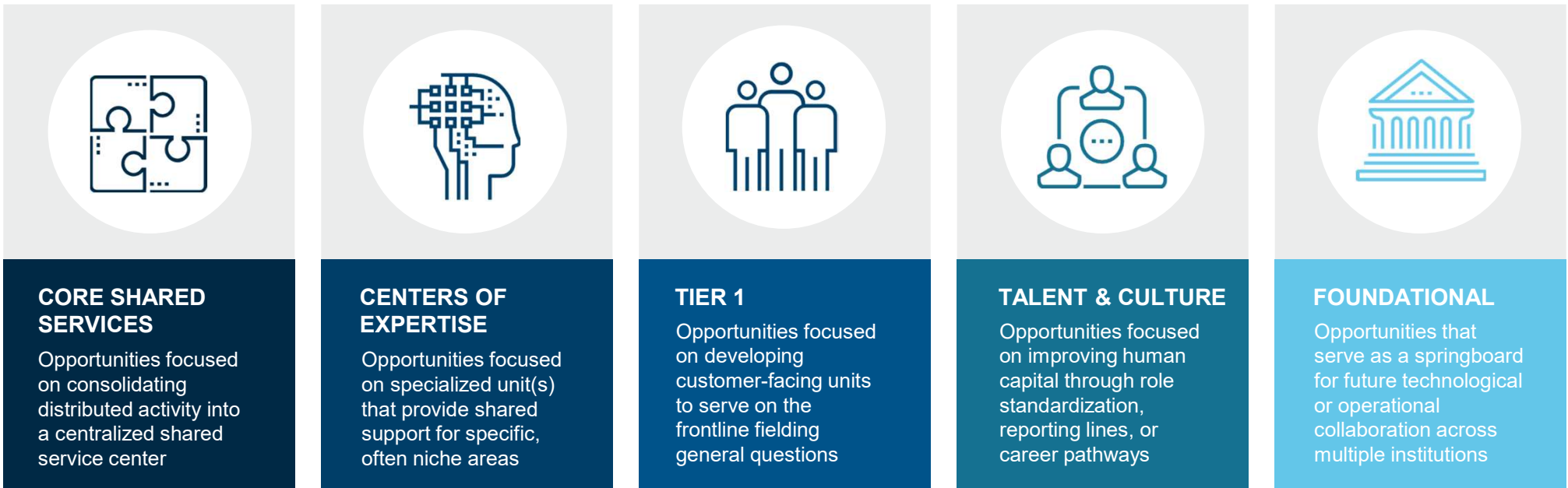

# Opportunities & Regionality

In addition to scale and category, Huron also approached group opportunities with considerations of regionality. While remote work has reduced barriers, geography remains an important factor.

- USHE is comprised of 16 institutions across Utah that have **discrete pockets of institutional density** in various regions.
- In Huron's experience, regionality can be a key consideration in multi-institution shared services, which often improves **the ease of implementation and adoption**.
- For select opportunities included in this report, **regionality may be a critical element in next step design activities**, particularly those that are inclusive of a large set of USHE institutions.
- While Huron's opportunities were developed with this framework in mind, **more detailed regionality elements** will be integrated during any subsequent design phase.

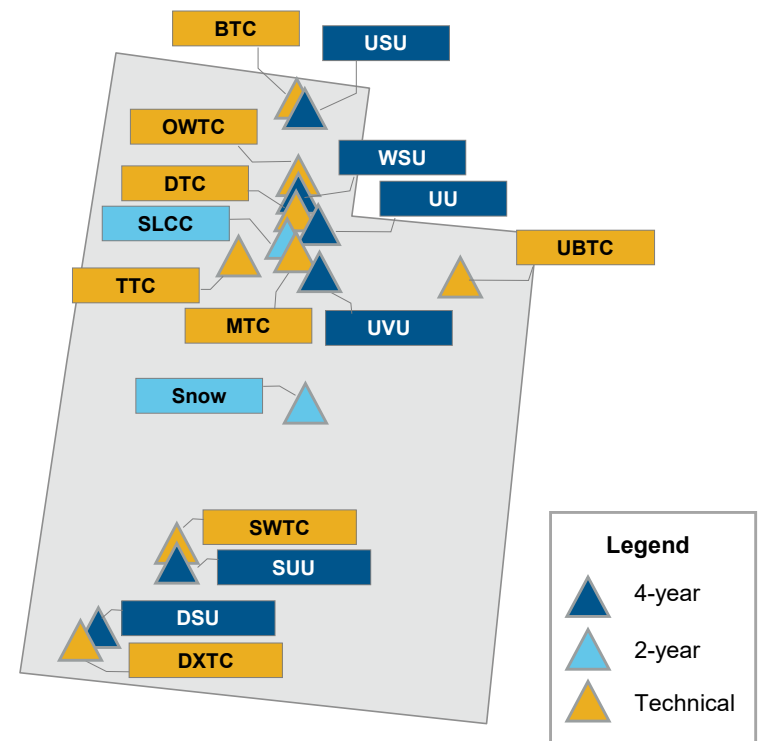



# Opportunity Layout

Each slide includes a case for change, supporting analyses, industry practice, and anticipated prerequisites.

- 1 **Scale & Area:** Details the functional area(s) and applicable scale of the opportunity
- 2 **Rationale:** Outlines the core rationale for pursuing the described opportunity
- 3 **Industry Practice:** Provides peer or industry insights related to the described opportunity
- 4 **Prerequisites:** Describes key activities that must be completed in order to pursue the implementation of the described opportunity
- 5 **Supporting Analysis:** Qualitative or quantitative analysis further supporting the described opportunities

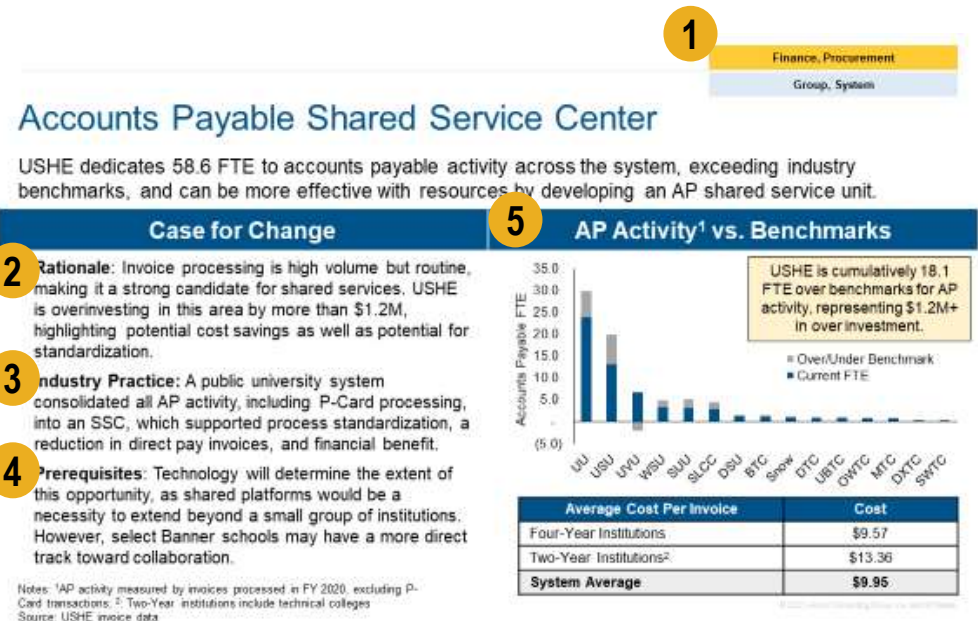

# Opportunity List

## Core Shared Services (1/2)

	Opportunity Scale			HR	Finance	Procurement	IT
Accounts Payable Shared Service Center		Group	System		✓	✓	
Travel and P-Card Processing	Local	Group	System		✓	✓	
Shared Benefits Plans		Group	System	✓			
Payroll Shared Service Center		Group		✓	✓		
Payroll Outsourcing	Local	Group	System	✓	✓		
System Accounting Services		Group	System		✓		
Internal Audit and Enterprise Risk Management		Group	System		✓		
Strategic Sourcing		Group	System			✓	

# Opportunity List

## Core Shared Services (2/2)

	Opportunity Scale			HR	Finance	Procurement	IT
<b>Align Local and Central Treasury Resource Support</b>	Local	Group	System		✓		
<b>Refine Treasury Operating Model</b>	Local	Group	System		✓		
<b>Website Development &amp; Maintenance</b>	Local	Group					✓

# Opportunity List

## Centers of Expertise

	Opportunity Scale			HR	Finance	Procurement	IT
Security Operations Center		Group	System				✓
Data Analytics and Reporting			System				✓
Onboarding & Experience Program	Local	Group		✓			
Employment Law		Group	System	✓			
Procurement Operating Model		Group	System			✓	
Performance Management		Group	System	✓			
Project Management Office (PMO)	Local	Group	System	✓	✓	✓	✓

# Opportunity List

## Tier 1

	Opportunity Scale			HR	Finance	Procurement	IT
Help/Service Desk	Local	Group	System				✓
Travel Support Center		Group	System		✓	✓	
Benefits Administration	Local	Group	System	✓			

# Opportunity List

## Talent & Culture

	Opportunity Scale			HR	Finance	Procurement	IT
Leave Policy Standardization	Local	Group	System	✓			
Centralized Recruitment Operations	Local	Group		✓			
Increase Managerial Spans of Control	Local			✓	✓	✓	✓
Talent Acquisition Collaborative		Group	System	✓			

# Opportunity List

## Foundational Opportunities

	Opportunity Scale			HR	Finance	Procurement	IT
System Policy Framework			System	✓	✓	✓	✓
Standardize Procurement Platforms		Group	System		✓	✓	
Chart of Accounts Standardization		Group	System		✓	✓	
Compensation & Classification	Local	Group	System	✓			
Systemwide ERP			System	✓	✓	✓	✓

# Opportunity List

## Local Opportunities (1/3)

	Institution	HR	Finance	Procurement	IT
Embedded HR Model	UU	✓			
Academic Advising	UU	✓	✓		
Increase Centralized Procurement	UVU			✓	
Centralize Select Finance Activities	WSU		✓		
Project Management Office	DTC	✓	✓	✓	✓
Finance Training	BTC		✓		
Standardize & Specialize Roles	DXTC	✓	✓	✓	✓
Reporting Relationships	DSU	✓	✓	✓	✓



# Opportunity List

## Local Opportunities (2/3)

	Institution	HR	Finance	Procurement	IT
IT Centralization	SLCC	✓	✓	✓	✓
Database Administration	SUU				✓
Project Management Office	SWTC	✓	✓	✓	✓
Procurement Centralization	UBTC			✓	
IT Service Delivery	USU				✓
Budgetary Support	Snow		✓		
IT Investment	TTC				✓
Transactional Activity	MTC		✓		

# Opportunity List

Local Opportunities (3/3)

	Institution	HR	Finance	Procurement	IT
Finance Specialization	OWTC		✓		

# 2a

---

## Core Shared Services

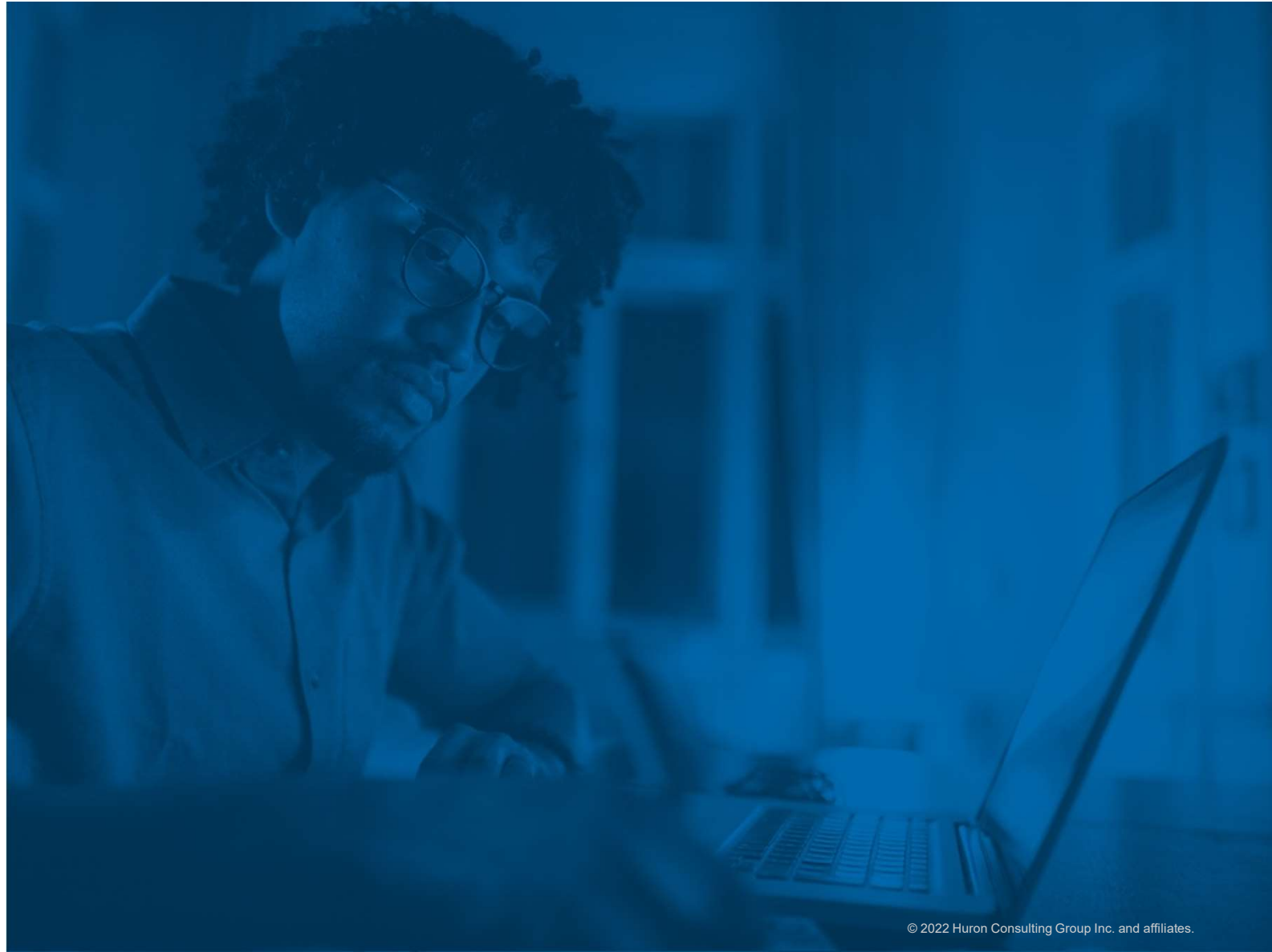

# Accounts Payable Shared Service Center

Invoice and payment processing is a high-volume but routine activity which makes it a strong candidate for shared services.

## Case for Change

- **Rationale:** USHE dedicates 58.6 FTE to accounts payable activity across the System and exceeds industry benchmarks by more than \$1.2M in cost, which highlights potential cost savings and standardization opportunities.
- **Industry Practice:** A public university system consolidated all AP activity, including P-Card processing, into an SSC, which supported process standardization, a reduction in direct pay invoices, and financial benefit.
- **Prerequisites:** Technology will determine the extent of this opportunity, as shared platforms would be a necessity to extend beyond a small group of institutions. However, select Banner schools may have a more direct track toward collaboration.

## AP Activity<sup>1</sup> vs. Benchmarks

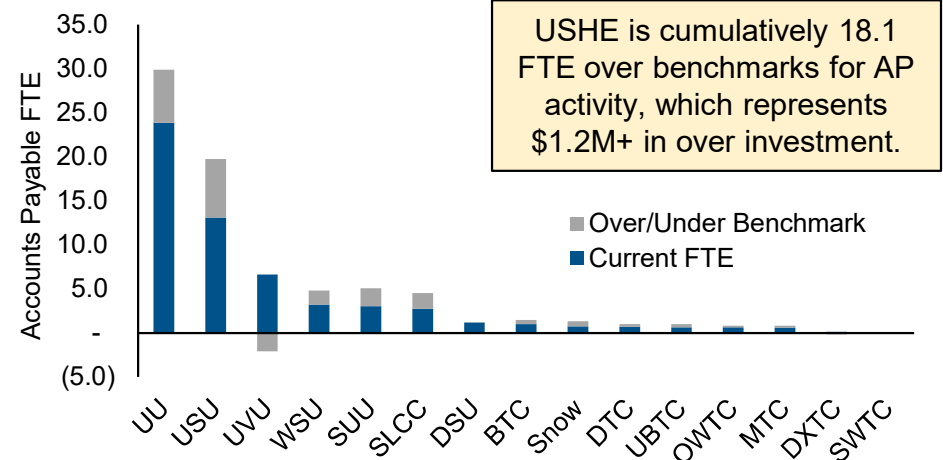

Average Cost Per Invoice	Cost
Four-Year Institutions	\$9.57
Two-Year Institutions <sup>2</sup>	\$13.36
<b>System Average</b>	<b>\$9.95</b>

Notes: <sup>1</sup>AP activity measured by invoices processed in FY 2020, excluding P-Card transactions; <sup>2</sup>Two-Year institutions include technical colleges  
Source: USHE invoice data; benchmarking data per APQC report

# Travel and P-Card Processing

Centralizing travel-related and P-Card processing in a singular unit can reduce the administrative burden placed on campus administration and free up critical employee capacity.

## Case for Change

- **Rationale:** Travel and P-Card processing is transactional work that costs approximately \$4.8M in annual expense. A central office would reduce the administrative burden on campuses, where 24% of all related effort is delivered by employees with manager or director level titles.
- **Industry Practice:** Several university systems use central units for travel, T-Card, and P-Card processing. The University of Illinois System uses a web-based system for managing both processes and related areas and reconciles the activity from the system office.
- **Prerequisites:** In order to maximize efficiency, there would be a review of policies and procedures and a consideration of technology investment to streamline expense submission for processing.

## Travel and P-Card Expenditures

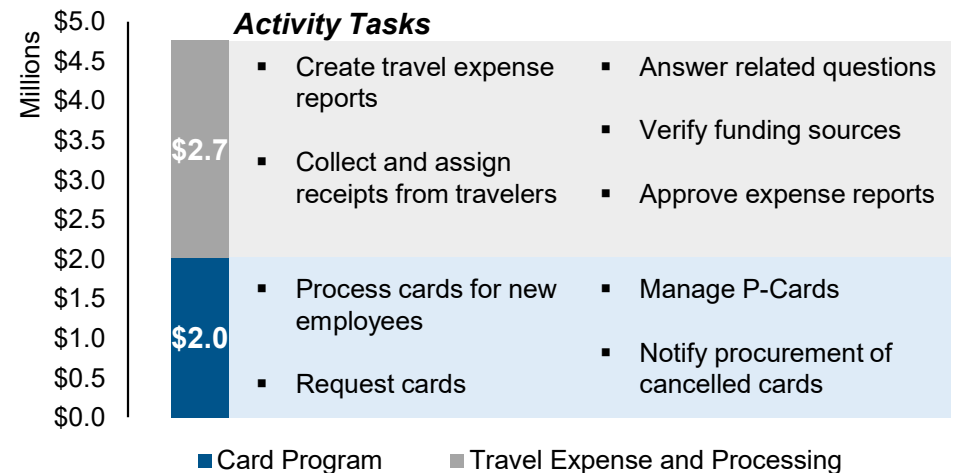

Employees with manager or director level titles currently spend **\$1.5M** on travel and expense and administering card programs related to travel and expense.

# Shared Benefits Plans

USHE can reduce inconsistency and improve employee satisfaction by implementing shared benefits plans that start with a focus on supplementary benefits and ramp up to health and retirement.

## Case for Change | USHE Fringe Rates<sup>2</sup>

- **Rationale:** USHE spends \$450.3M<sup>1</sup> on benefits and lacks any shared benefit plans. Implementing common benefits across the System, such as a shared EAP or supplemental benefits, will increase systemwide collaboration and open the door to bigger opportunities, such as health and retirement benefits.
- **Industry Practice:** The University System of New Hampshire has a shared EAP and a voluntary benefit coverage for disability insurance. All benefits-eligible employees throughout the System can enroll in the plans.
- **Prerequisites:** Current benefit plans would be inventoried with resources made available to employees to navigate any changes in administration and to ensure a high level of customer service.

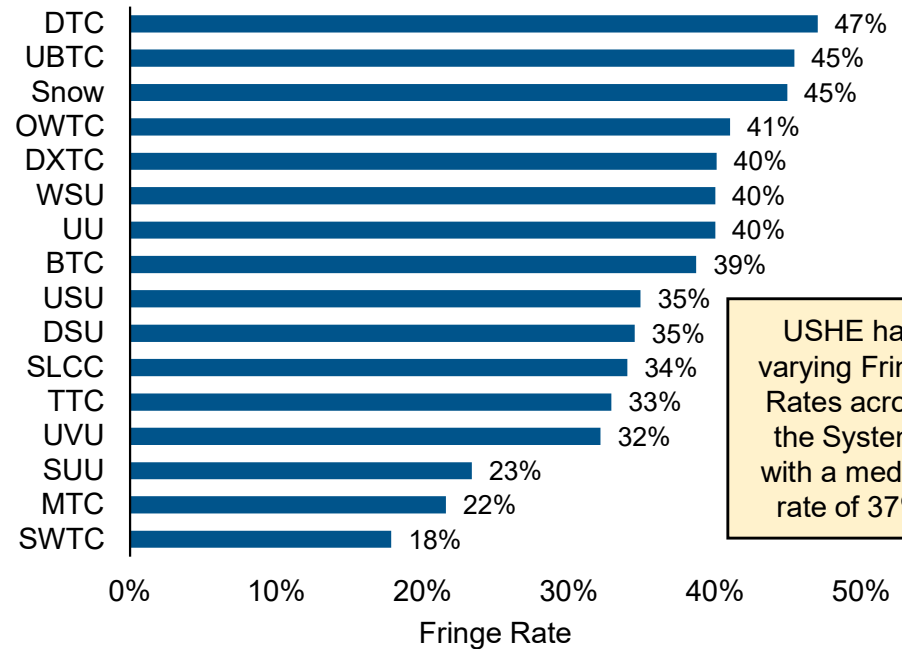

Source: <sup>1</sup>USHE Financial Expenditures by Year

Note: <sup>2</sup>Select institutions do not utilize official fringe rates; in those instances, fringe was estimated from total cost of benefits and compensation taken from the institutions' financial statements.

# Payroll Shared Service Center

USHE can increase efficiency, reduce risk, and improve service through the implementation of a payroll shared service center across its technical colleges.

## Case for Change

- Rationale:** USHE Technical Colleges invest 3.3 FTE in payroll activities, which highlights the area as under resourced; only MTC contributes more than one FTE.
  - In areas related to payroll reconciliation and audit, technical colleges cumulatively contributed just 1.1 FTE. This creates risks for over and underpayments, tax regulation compliance, and business continuity.
- Industry Practice:** USNH created a payroll shared service center to align staffing with benchmarks and standardizing processes systemwide.
- Prerequisites:** In advance of implementation, there would need to be a standardization and mapping of processes to align institutions with the new structure<sup>1</sup>.

Note: <sup>1</sup>This effort would include identification of check printing and direct deposit capabilities, banking partners, and other relevant areas; <sup>2</sup>Institutional FTE in hundreds

## Technical College Investment in Payroll

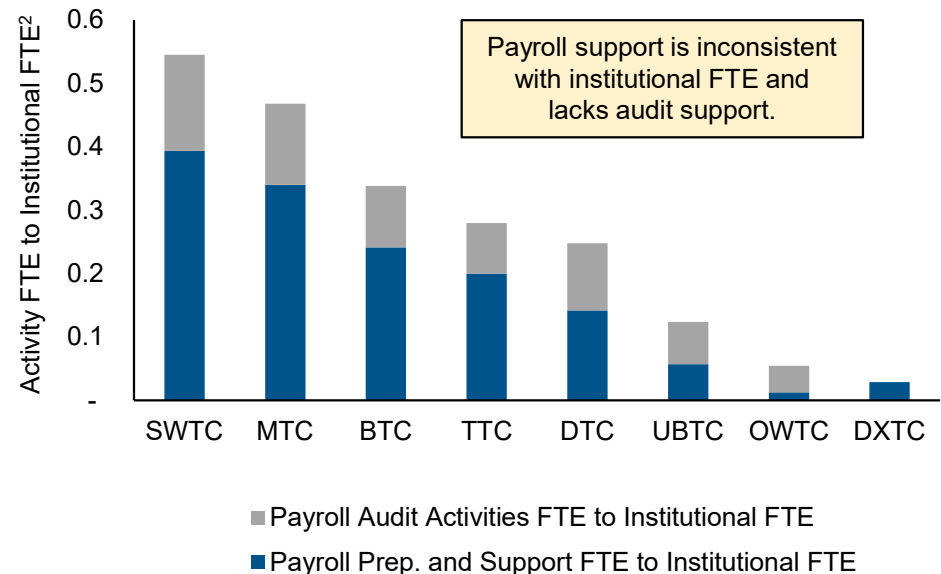

# Payroll Outsourcing

Outsourcing payroll activities across the System could achieve approximately \$600K in annual savings while standardizing and improving service levels.

## Case for Change

- **Rationale:** USHE institutions invest approximately \$3.9M and 46.3 of FTE annually in payroll processing and is over double applicable benchmarks in cost per paycheck.
  - Outsourcing pay calculations, distribution, tax remittances, etc. can improve and standardize service quality, which varies cross the System, with some institutions lacking the resources for industry standard levels of service.
- **Industry Practice:** While many institutions, such as CU Boulder and the USG System outsource elements of payroll, higher education has resisted full outsourcing.
- **Prerequisites:** Successful outsourcing is dependent on the partner selected and System decision making on levels of customization and standardization.

Sources: Internal benchmarks, prior client vendor benchmarking, estimates based on extrapolation of internal reference data

## Cost Overview

### Cost per Paycheck

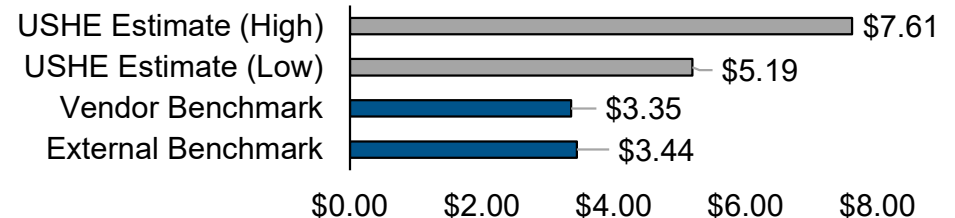

Institution	Total
USHE Payroll Processing Spend	\$3.9M
Estimated Annual Vendor Cost	\$3.3M
<b>Estimated Annual Savings</b>	<b>\$600K</b>

Range does not include implementation expenses



# System Accounting Services

By providing general accounting services to each institution, USHE could improve financial controls and help create efficiencies in processing activities.

Case for Change	Finance Function Activities		
	Level of Complexity		
	Processing	Technical	Strategic
<ul style="list-style-type: none"> <li>▪ <b>Rationale:</b> General accounting costs USHE \$12.1M and 150.7 FTE per year. The work is mainly processing activities, such as journal entries and reconciliation work, that can be performed with efficiency at scale and would give the System Office increased insights into financial activity across the System.</li> <li>▪ <b>Industry Practice:</b> USNH centralized all general accounting activities across the state into a central office, with campuses experiencing no noticeable disruptions in service and increases in employee processing efficiency.</li> <li>▪ <b>Prerequisites:</b> A unified chart of accounts and financial systems help to achieve optimal efficiency while detailed process mapping, identification of services provided, and policy controls are necessary to shift the activity to the shared service center.</li> </ul>	<div style="border: 1px solid orange; padding: 5px;">                     General Accounting                      Cost: \$12.1M                 </div>	<div style="padding: 5px;">                     Reporting and Data Management                      Cost: \$7.3M                 </div>	<div style="padding: 5px;">                     Financial Analysis and Reporting                      Cost: \$12.6M                 </div>
	<div style="padding: 5px;">                     Billing and Receivables                      Cost: \$12.1M                 </div>	<div style="padding: 5px;">                     Systems Administration                      Cost: \$2.0M                 </div>	<div style="padding: 5px;">                     Budgeting, Treasury, Financial Management                      Cost: \$11.2M                 </div>
	<div style="padding: 5px;">                     Patient Accounting                      Cost: \$1.1M                 </div>		

➔ General accounting represents the highest cost finance activity in the least complex area

Note: Activity boxes are illustrative and are not scaled to size

# Internal Audit and Enterprise Risk Management

Operating enterprise risk management and compliance as a shared service will mitigate audit risks by ensuring that processes are consistently and appropriately monitored.

## Case for Change

- **Rationale:** Over 800 employees systemwide perform compliance related activity, which results in unspecialized and distributed processes and greater exposure to risk. Consolidating risk management will create specialists dedicated to risk management and provide the necessary resources to ensure compliance across the System.
- **Industry Practice:** At the University of California system, a central risk management office was implemented to identify and manage potential risks across the System.
- **Prerequisites:** Institutions have varying financial processes which would need to be standardized before engaging in centralization. Capacity is also low across the System, which prompts consideration of resourcing and strategic investment.

Note: Size of bubble reflects total institutional spend on compliance related activity

## Institutional Investment in Compliance

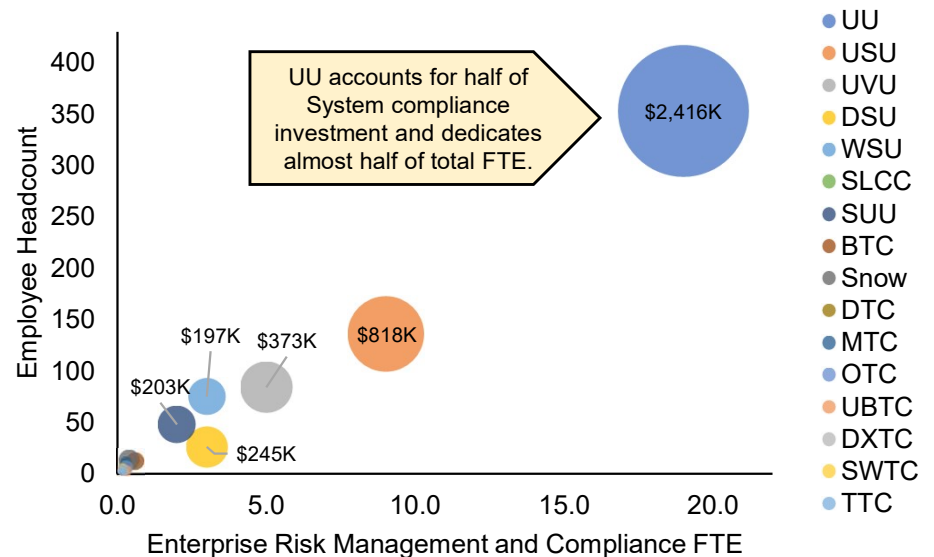

**9 of the 16 institutions within USHE dedicate less than 1 FTE and invest less than \$100,000 in compliance.**

# Strategic Sourcing

Initial analysis of 4 representative USHE institutions had an estimated \$1,602M in FY21 vendor spend, about \$748M of which can potentially be addressed by sourcing activities to decrease future spend.

## Case for Change

- **Rationale:** Cleansed, standardized, and categorized FY20 and FY21 spend reveals that 13% of FY21 addressable spend is with suppliers used by all four institutions. An estimated \$6M-\$12M in cost savings opportunities can be achieved through sourcing activities to include leveraging buying power, demand management, and utilization of contracts.
- **Industry Practice:** Various universities and university systems have implemented strategic sourcing opportunities to yield potential cost savings as well as create more efficient procurement processes.
- **Prerequisites:** Each institution has varying contract review processes which will require further discussion in determining how to develop a sourcing savings roadmap.

Source: <sup>1</sup>FY20, FY21 Invoice and P-card data UU, USU, SLCC, and DTC

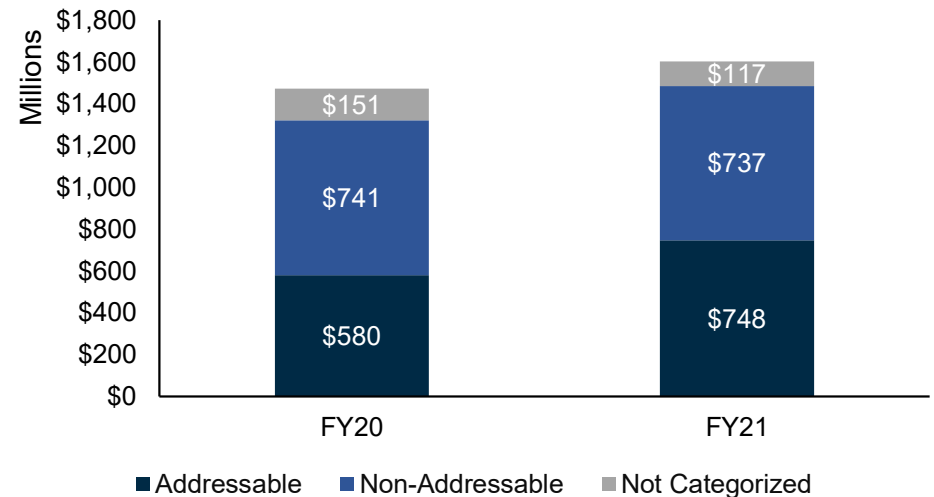

## Estimated FY20, FY21 Spend<sup>1</sup>



FY21 Addressable Spend ~\$748M; 93% categorized.

# Align Local and Central Treasury Resource Support

USHE can optimize local cash and treasury support for its 16 institutions by standardizing roles and right-sizing consistent levels of support across the institutions.

Case for Change	Recommended Staffing Considerations	
<ul style="list-style-type: none"> <li>▪ <b>Rationale:</b> Schools and colleges have autonomy to decide how to organize cash and treasury management responsibilities. Staffing levels should align with the current volume of treasury transactions, current technologies in place, and balance risks of the schools and colleges. Furthermore, roles should be standardized to provide adequate levels of support.</li> <li>▪ <b>Industry Practice:</b> Best practice entails a system-level treasurer overseeing and maintaining all key bank relationships and setting which services are managed centrally vs. locally. This can increase financial controls, limit fraud risks, and consolidates banking relationships.</li> <li>▪ <b>Prerequisites:</b> USHE would require governance restructuring to implement shared treasury support.</li> </ul>	Areas for Consideration when Choosing a Support Model:	<u>Staffing Efficiency</u> Conservative      Optimal
	Are cash/ treasury processes <b>manual or inefficient</b> ?	 Higher levels of automation lead to more efficient staffing (lower FTEs)
	Are cash/ treasury <b>specialists</b> focused only on cash/ treasury processes or <b>generalists</b> with a boarder scope of responsibilities (e.g. purchasing, HR, payroll)?	 Limiting scope of services leads to more efficient staffing (lower FTEs)
Is the support model/staff <b>new or in a pilot phase</b> as processes, and roles and responsibilities are being standardized?	 As the organization matures and staff are fully trained, the staffing model becomes more efficient (lower FTEs)	

# Refine Treasury Operating Model

USHE can enhance its treasury operations' value-proposition by shifting focus from 'traditional' to 'leading' activities across key treasury functions.

Case for Change	Operating Model & Activity Indicators		
	Traditional	Strategic	Leading
<ul style="list-style-type: none"> <li>▪ <b>Rationale:</b> Shifting from traditional to leading practices either at the local, group, or system-level will enable USHE to optimize cash and treasury services to increase functionality, reduce banking and staffing costs, and increase USHE's sophistication with money management.</li> </ul>	Ad hoc; limited tracking & reporting	Visibility and tracking of relationships	Optimized relationships based on functionality, needs, & costs
<ul style="list-style-type: none"> <li>▪ <b>Industry Practice:</b> Industry leading practices have optimized banking relationships that provide services at the lowest possible cost, automated technologies for effective cash rebalancing, investing, and reporting, and structures to manage risk.</li> </ul>	Limited awareness of total bank fees & services	Awareness of total cost of banking relationship	Periodic review & re-balance of banking services
<ul style="list-style-type: none"> <li>▪ <b>Prerequisites:</b> Per the level of centralization, governance models may need to be revised. Business processes and banking partners will be compiled for review.</li> </ul>	Periodic review and rebalancing of cash investments	Robust cash investment policies and daily or weekly manual rebalancing	Automated rebalancing & cash investment to accounts
	Limited awareness & visibility of cash; manual reporting	Identified KPIs that align with cash investment policy	Automated cash reporting and visibility for mgmt.
	Limited awareness & manual processes	Partial automation, limited systems integration	Automated & integrated processes across systems

# Website Development & Maintenance

USHE institutions should develop an internal service center for website development & maintenance to alleviate a top source of employee frustration and improve internal and external effectiveness.

## Case for Change

- **Rationale:** Website development and maintenance often spans technical, inward-facing IT processes and outward-facing marketing (or similar) requirements. Centralizing and streamlining the technical processes can provide more consistent service to the institutions.
- **Industry Practice:** Many institutions have adopted robust content management systems along with content governance structures which allows for monitoring of website performance and enforcement of policies with respect to accessibility, privacy, and security.
- **Prerequisites:** In addition to standard content, each institution will have individual needs that must be included in the content governance structure to assure that web content changes can be made in a timely manner.

<sup>1</sup> Source: IT Staffing Ratios, Computer Economics, 2020.

## Web Development FTE vs. Benchmark<sup>1</sup>

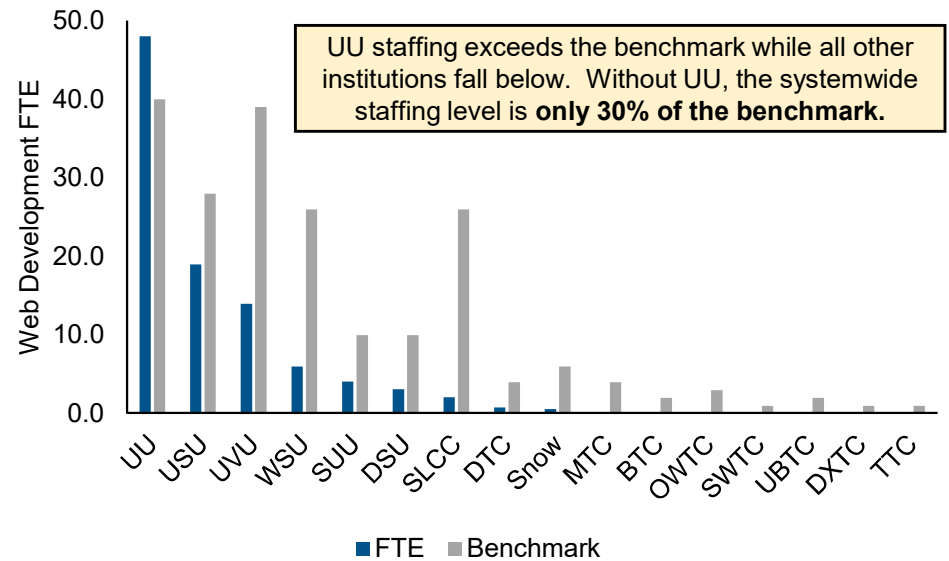

**The OFI identified website development technology and process as critical areas for improvement.**

# 2b

---

Centers of  
Expertise

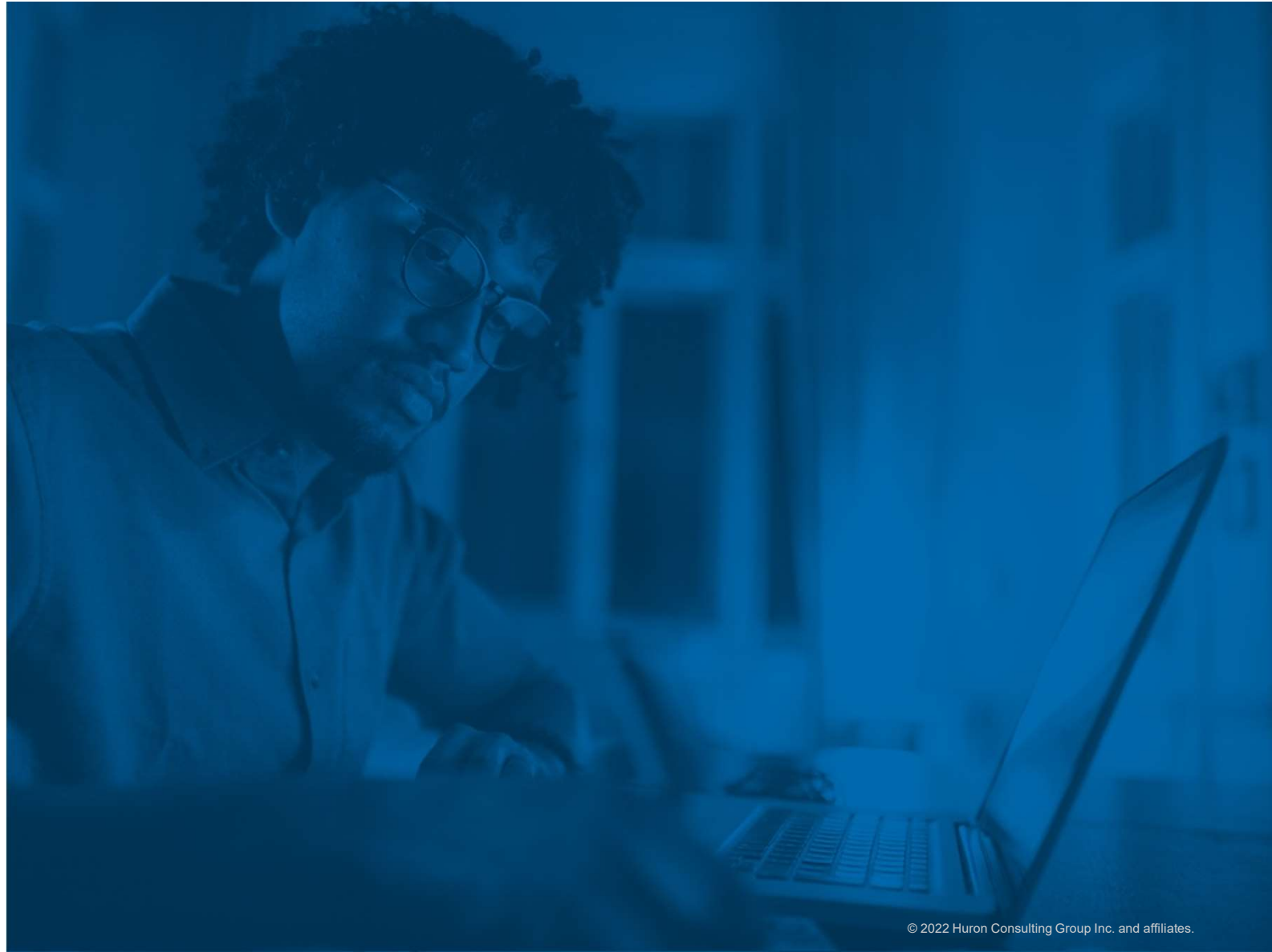

# Security Operations Center

USHE currently combats security threats at an institution-level, which has led to past ransomware attacks. Creating a Security Operations Center will help reduce vulnerability and mitigate risks.

## Case for Change

- **Rationale:** A systemwide Security Operations Center (SOC) mitigates the needs for institutions to fund and build out operations themselves. Leveraging the UETN, implementation may be streamlined to increase efficiencies and assist in the avoidance of potential security breaches.
- **Industry Practice:** The State University of New York (SUNY) implemented a SOC that provides expertise, training, and resources around information security.
- **Prerequisites:** Each institution has a unique environment that requires specialized security. Implementation would first need to assess what types of security each institution needs and then design the SOC to be able to provide customizable support.

## IT Security Staffing vs. Benchmark<sup>1</sup>

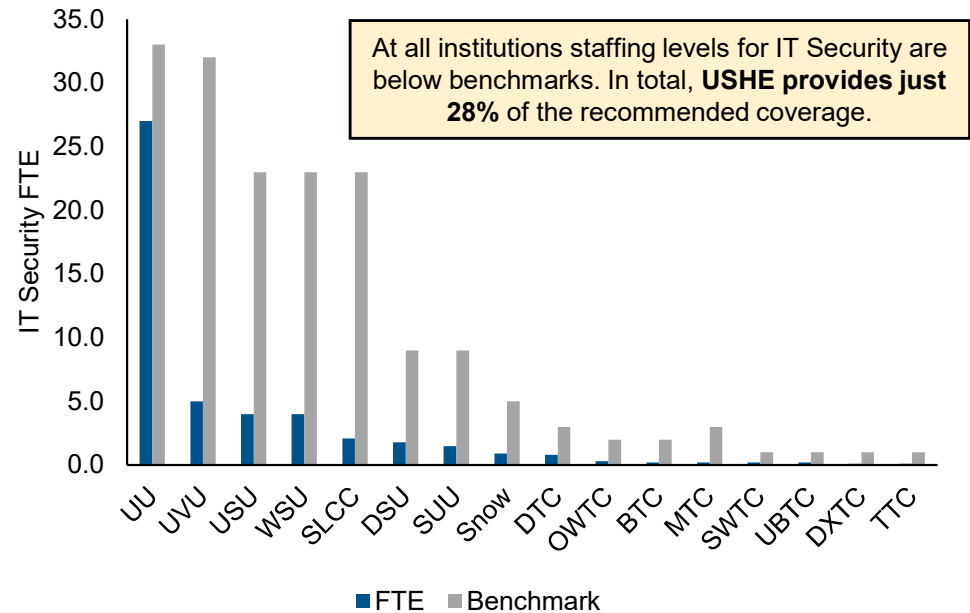

<sup>1</sup>Source: IT Staffing Ratios, Computer Economics, 2020.



# Data Analytics and Reporting

The USHE System office should provide a consolidated center of expertise for analytics, which would increase the sophistication of data use and promote data standards.

## Case for Change

- **Rationale:** The percentage of institutional core expenses dedicated to reporting and analytics range from about 1.8% to less than 0.1%, yet the System must collect and aggregate data from all institutions to obtain high-level insights. Reports posted online by the System currently have limited granularity as a result.
- **Industry Practice:** Other large state systems are exploring the role of data analytics at the system level to help inform policymakers as well as institutional executives in their decision-making processes.
- **Prerequisites:** This effort would require buy-in from the IT, IR, and functional users across all USHE institutions, to create and maintain systemwide data definitions and change management processes to adapt over time.

<sup>1</sup> Core Expense data from IPEDS, 2019

## Reporting Activity Analysis

Reporting vs. Core Expense<sup>1</sup>

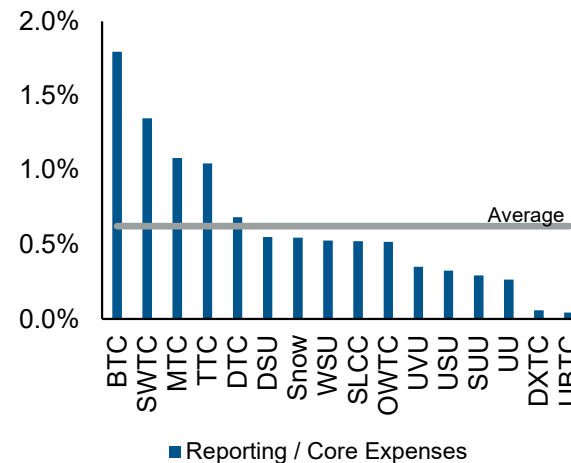

Reporting Expense

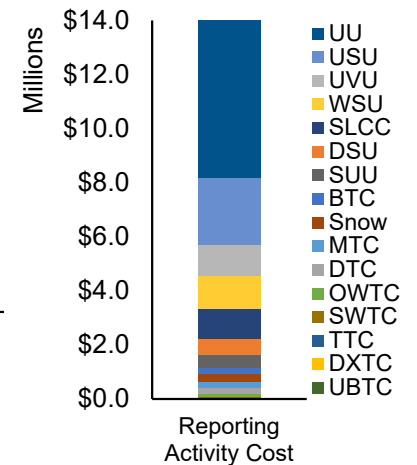

Almost 1500 staff across the system spend time on reporting for a total of about 150 FTE, which indicates a high degree of fragmentation.

# Onboarding & Experience Program

Establishing a central onboarding center of expertise at the local or group level will emphasize consistency and improve employee experience, at the point of hire as well as 30, 60, 90 days post-hire.

## Case for Change

- **Rationale:** Role descriptions and onboarding programs are inconsistent across the System, which impacts employee turnover and overall wellbeing. Centralizing the onboarding program will clarify role distribution as well as increase employee understanding and satisfaction.
- **Industry Practice:** At the University of Missouri System, employees are provided with onboarding resources to track their progress during their first year through a user-friendly website.
- **Prerequisites:** Many roles do not have clear descriptions as individuals inherently “wear many hats”. Standardization and outlining of role specific responsibilities will need to be completed to create an effective onboarding program.

Source: <sup>1</sup>Growth rates calculated from IPEDS 2020, 2019 total employee count data

## Onboarding Activity Overview

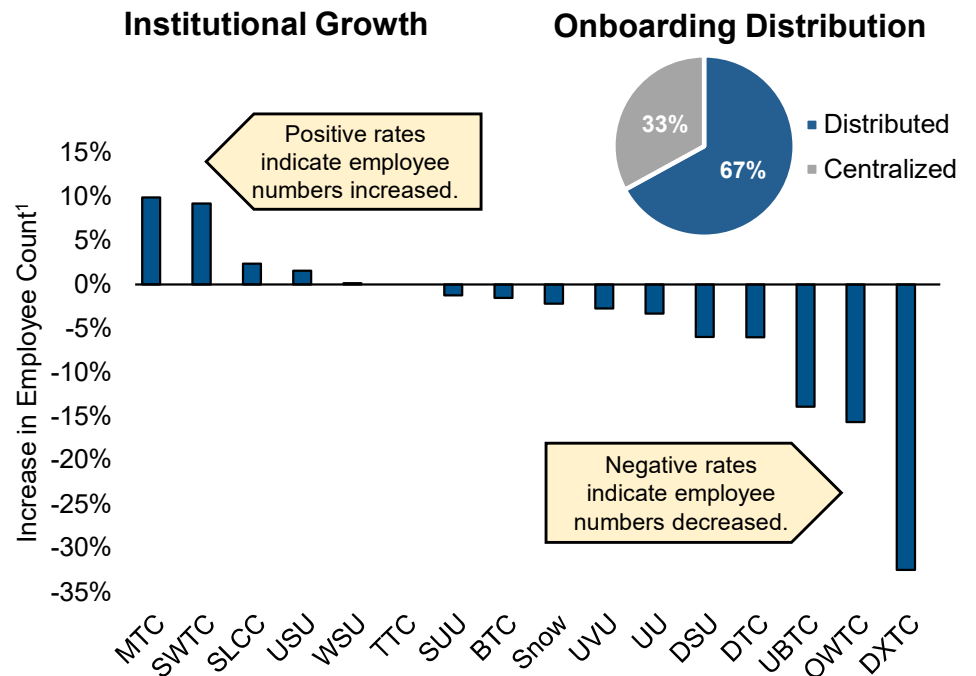

# Employment Law

USHE can reduce resource disparities and ensure employment law compliance by creating a center of expertise to support employee and labor relations efforts.

## Case for Change

- **Rationale:** Stakeholders discussed that employment law lacks systemwide resources and HAAS data shows that most institutions dedicate less than one FTE to employee and labor relations. Developing a center of expertise will increase compliance and capacity across the System through better supported employee and labor relations.
- **Industry Practice:** At the University of Chicago, a center of expertise was developed for Employee and Labor Relations to provide guidance around policy, contract administration, employment law compliance, performance management, and leaves of absence.
- **Prerequisites:** Each institution has their own unique set of policies. In order to develop a well-functioning CoE, experts would have to have extensive knowledge of all policies throughout the System or group.

## Employee & Labor Relations Support

Institutional FTE per Employee & Labor Relations FTE

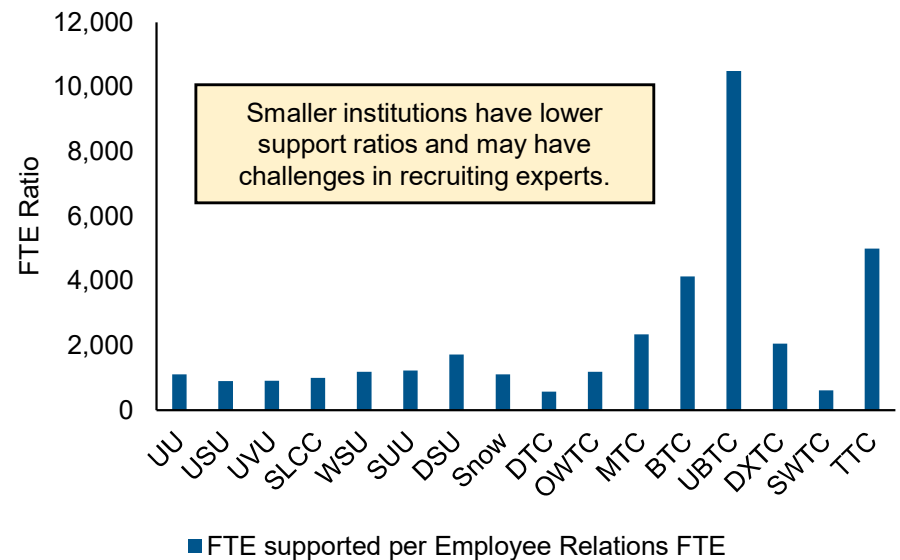

# Procurement Operating Model

Procurement's value-proposition can be enhanced by focusing on increased collaboration, improved data visibility, optimized systemwide spend, and a reduction in redundant workload between institutions.

## Case for Change

- **Rationale:** A centralized operating model would lead to consistent review of spend areas across institutions. This would increase procurement collaboration which could lead to potential cost savings, an improvement in data visibility and quality, and reduction of redundant work.
- **Industry Practice:** The University of Tennessee system implemented a center-led procurement operating model that has one CPO who is accountable to coordinate and achieve established goals and KPIs across the system. The system office also assists with standardization, best practices, and talent management.
- **Prerequisites:** Currently, institutions have varying procurement systems. Moving to a common procurement system would need to first occur before implementing a new operating model.

## Operating Model Options



### EVENT FOCUS

USHE System Office helps identify collaboration opportunities and planning for single sourcing events.

Institutions have the structure to collaborate on sourcing events as needed.



### CATEGORY LEADERSHIP

USHE office provides category management services for institutions in high spend areas. Institutions manage all other categories.

Flexible approach with centrally managed strategy and autonomy for institutions to manage the non-center led spend categories and all transactional activities.



### CONSOLIDATED

Centralized function aggregates all procurement activities into a single USHE managed department.

USHE service center is responsible for managing all purchasing and contracting activities.

# Performance Management

Developing a center of expertise that acts as a resource center for best practices will support institutions in their performance management processes and their learning and development programs.

## Case for Change

- **Rationale:** Despite 700 employees contributing to performance management systemwide, OFI scores and workgroup feedback highlight a lack of consistency with performance management. A center of expertise will ensure that institutions have adequate resources to implement more strategic performance-related practices.
- **Industry Practice:** At a public research university, performance management was consolidated to increase process stability and to avoid duplicated efforts that produce inconsistent results.
- **Prerequisites:** Training and culture are specific to institutions, especially amongst the degree-granting vs. technical institutions. Resources should be easily customizable, rather than standardized, across the System to account for these differences.

## Performance Management OFI Scores

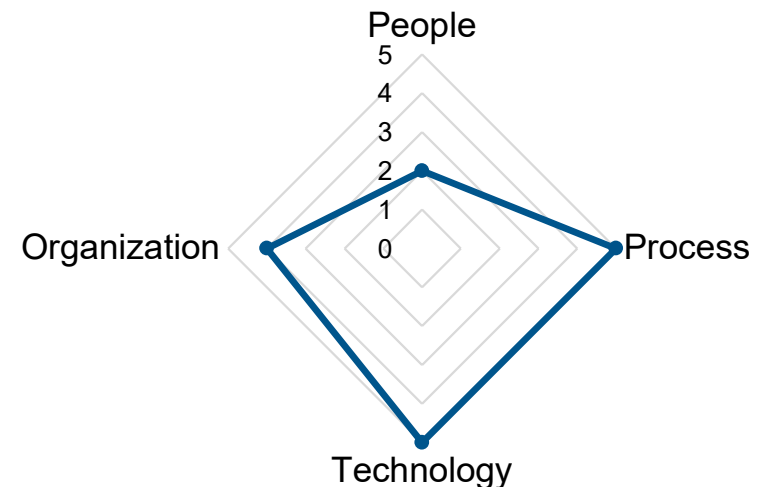

The OFI data identified Workforce Planning and Analysis as one of the top areas for improvement.

# Project Management Office (PMO)

Implementing a shared PMO structure could support institutions in more effectively driving their own process improvement, which was an area cited as under resourced by the institutions.

## Case for Change

- **Rationale:** PMOs support leaders in managing improvement initiatives where they otherwise would not have the capacity or expertise. USHE currently has a wide variance in this activity across the System which creates a large gap in the ability to drive continuous improvement.
- **Industry Practice:** Numerous institutions and systems establish project management units around functions (ex: IT PMOs) or spans of support (ex: systemwide initiatives), both of which provide transparency into available resources for significant initiatives.
- **Prerequisites:** Effective PMOs require clear mandates on their scope of services/oversight, which makes it critical to appropriately structure the unit around specific goals and ensure its staffing is tailored to those goals.

## Project Management FTE Investment

Despite representing 25% of expenditures, 12 institutions account for only 16% of USHE's Project Management FTE, which suggests a scarcity of project management support.

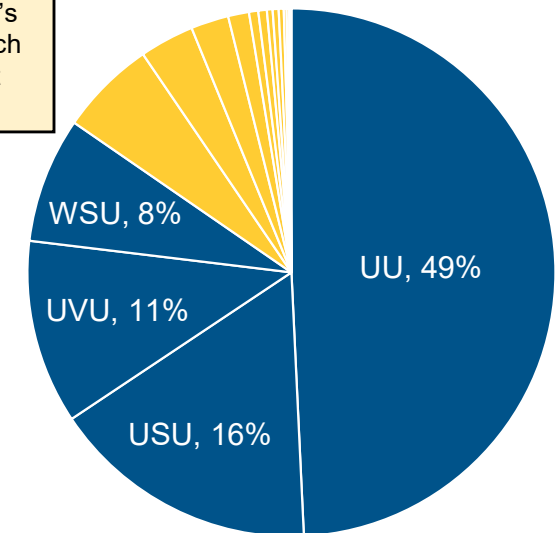

# 2c

---

Tier 1

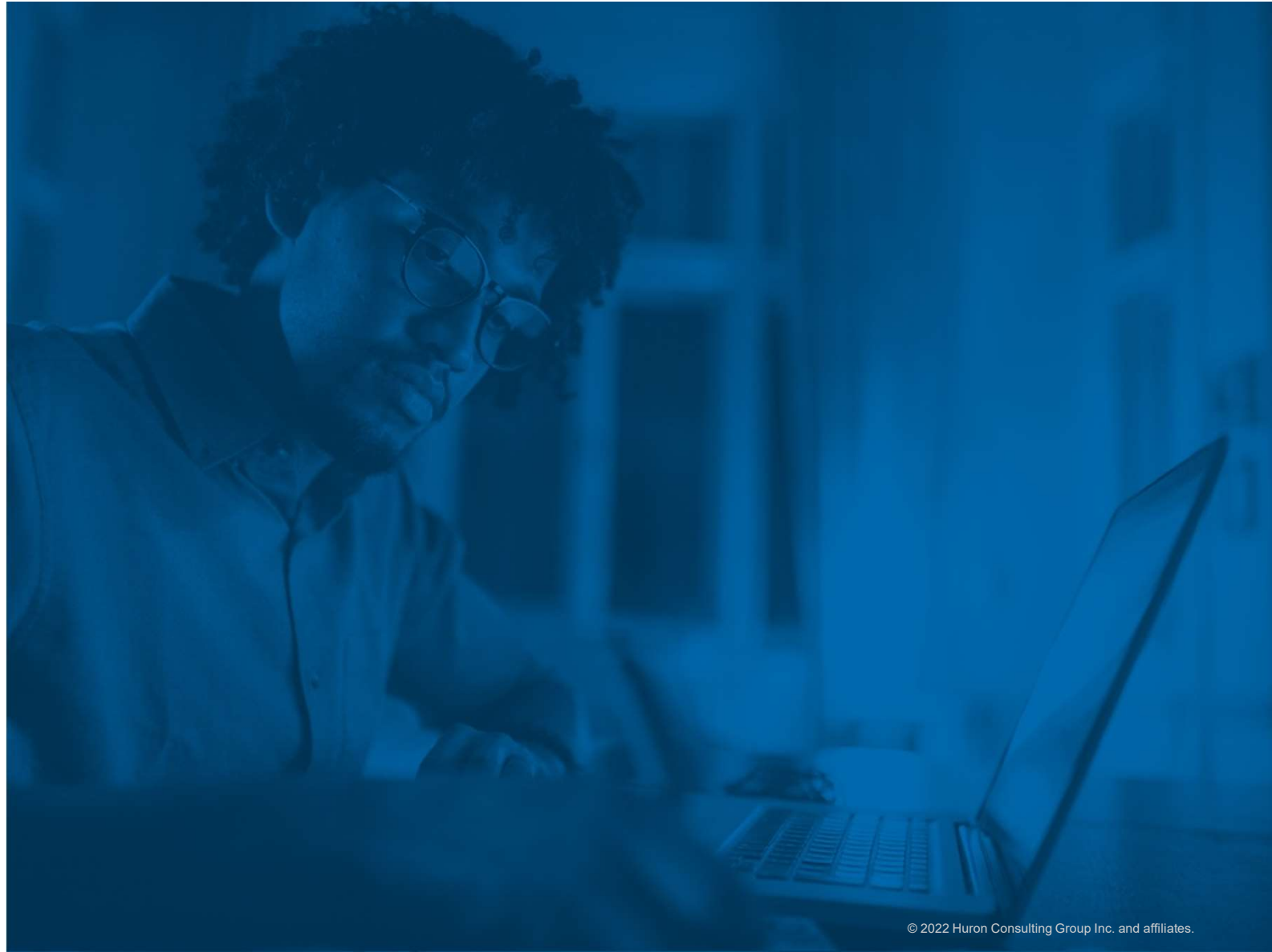

# Help/Service Desk

USHE utilizes a total of 129.7 FTE for IT service-related processes, which is far below industry benchmarks and highlights the potential for centralized local, group, or System IT Help Desks.

## Case for Change

- **Rationale:** Automation of processes and varying platforms calls for more timely resolution for technology problems. A tier 1 service desk will increase FTE dedicated to IT-related questions, which leads to greater efficiencies through faster turnaround time.
- **Industry Practice:** At a public university system, an IT service desk was implemented as a single point of contact for all technical questions including ERP support and security. Any exceptional cases are escalated to appropriate campus or departmental resources.
- **Prerequisites:** Varying technology across the System stands as a barrier to a systemwide help desk. Help desk staff will need to have a clear understanding of how to best answer questions that relate to these differences.

Source: <sup>1</sup>IT Staffing Ratios, Computer Economics, 2020.

## Help Desk Staff vs. Benchmark<sup>1</sup>

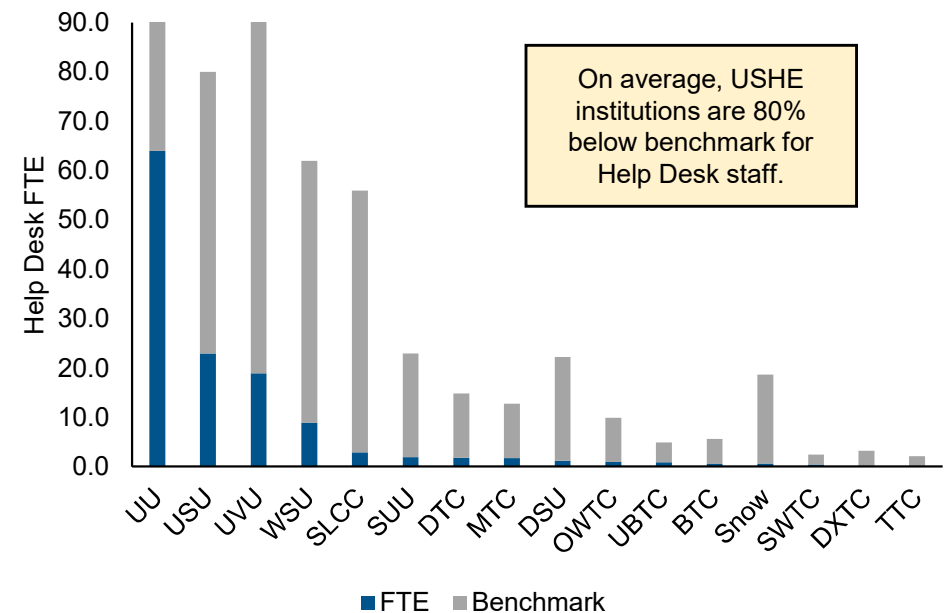



# Travel Support Center

Establishing a central travel support center to perform travel authorizations, bookings, and other processing activities would create expertise and reduce costs in the area.

## Case for Change

- **Rationale:** USHE institutions currently spend \$2.9M and 38.4 FTE across 1,500 employees on travel and requesting and booking. Due to the low level of technical skill required for the requisite activities, a center of expertise could offload some of the associated administrative burden while creating specialists in support.
- **Industry Practice:** Multiple university systems leverage travel & support experts, either through their own dedicated center or via outsourced travel agencies.
- **Prerequisites:** Prior to implementation, there would need to be detailed process mapping and standardization of policy in order to create efficiencies and the knowledge base to provide institutions with a high quality of service.

## Specialization of Travel Support

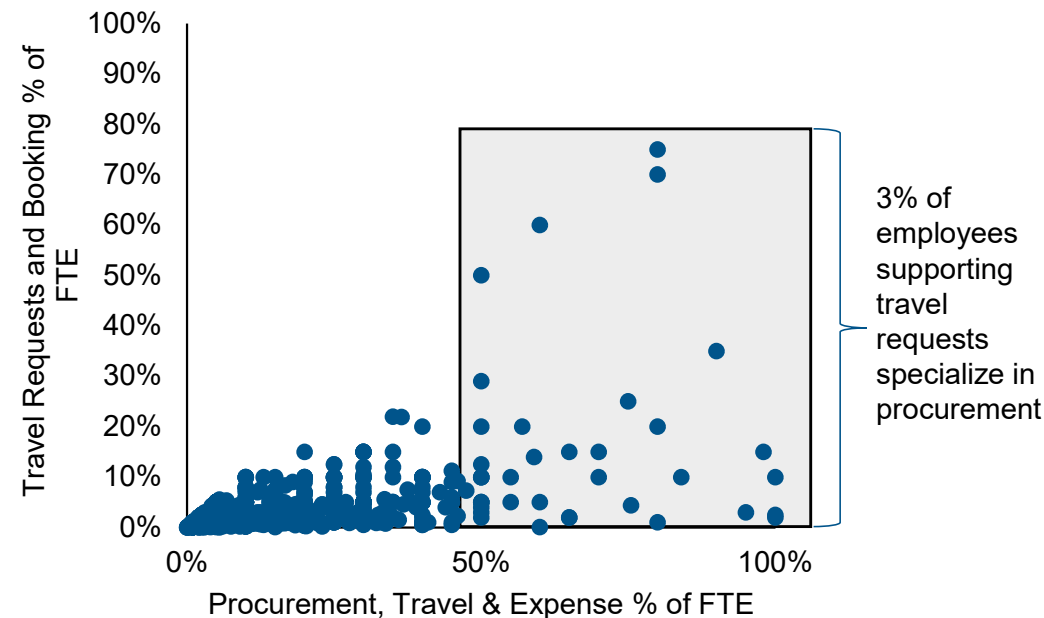

# Benefits Administration

USHE can improve service delivery and employee satisfaction by establishing tier 1 support focused on answering and appropriately triaging benefits-related inquiries.

## Case for Change

- **Rationale:** Across USHE, just 13.9 FTE is dedicated to benefits administration, which results in under-resourced and passive service delivery. A dedicated call center would provide a one-stop-shop for benefit and leave related questions to ensure consistency and increase customer satisfaction.
- **Industry Practice:** At the University of California System, a benefits-related website was created to view and manage benefits information. Services include viewing statements, updating tax withholdings, managing insurance allotments, and enrollment
- **Prerequisites:** Staff and faculty across institutions have varying benefits that are specific to their role. This should be addressed at the local level before administering a wider used shared service.

## Employee Time Spent in Benefits Admin

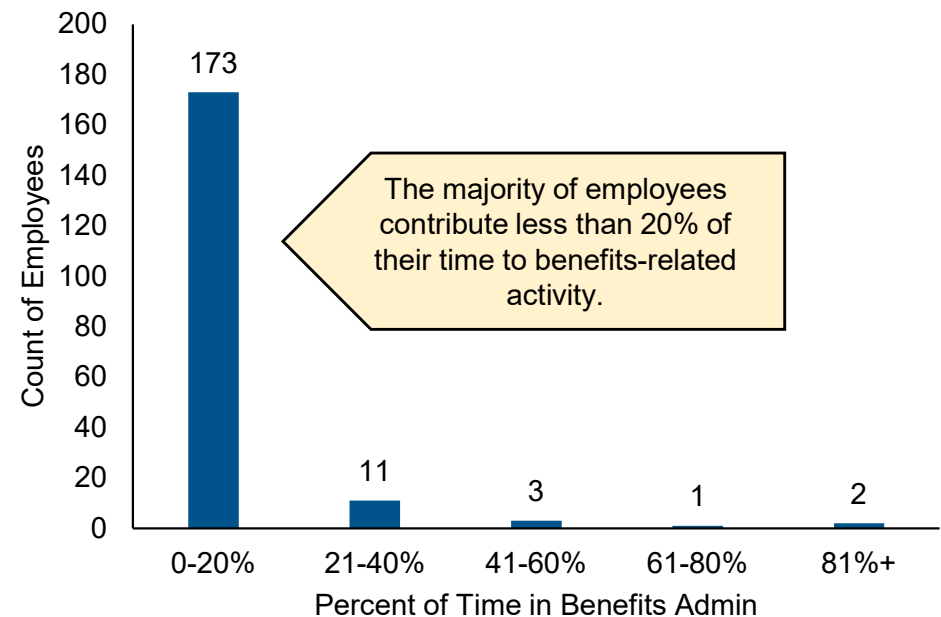

# 2d

---

Talent & Culture

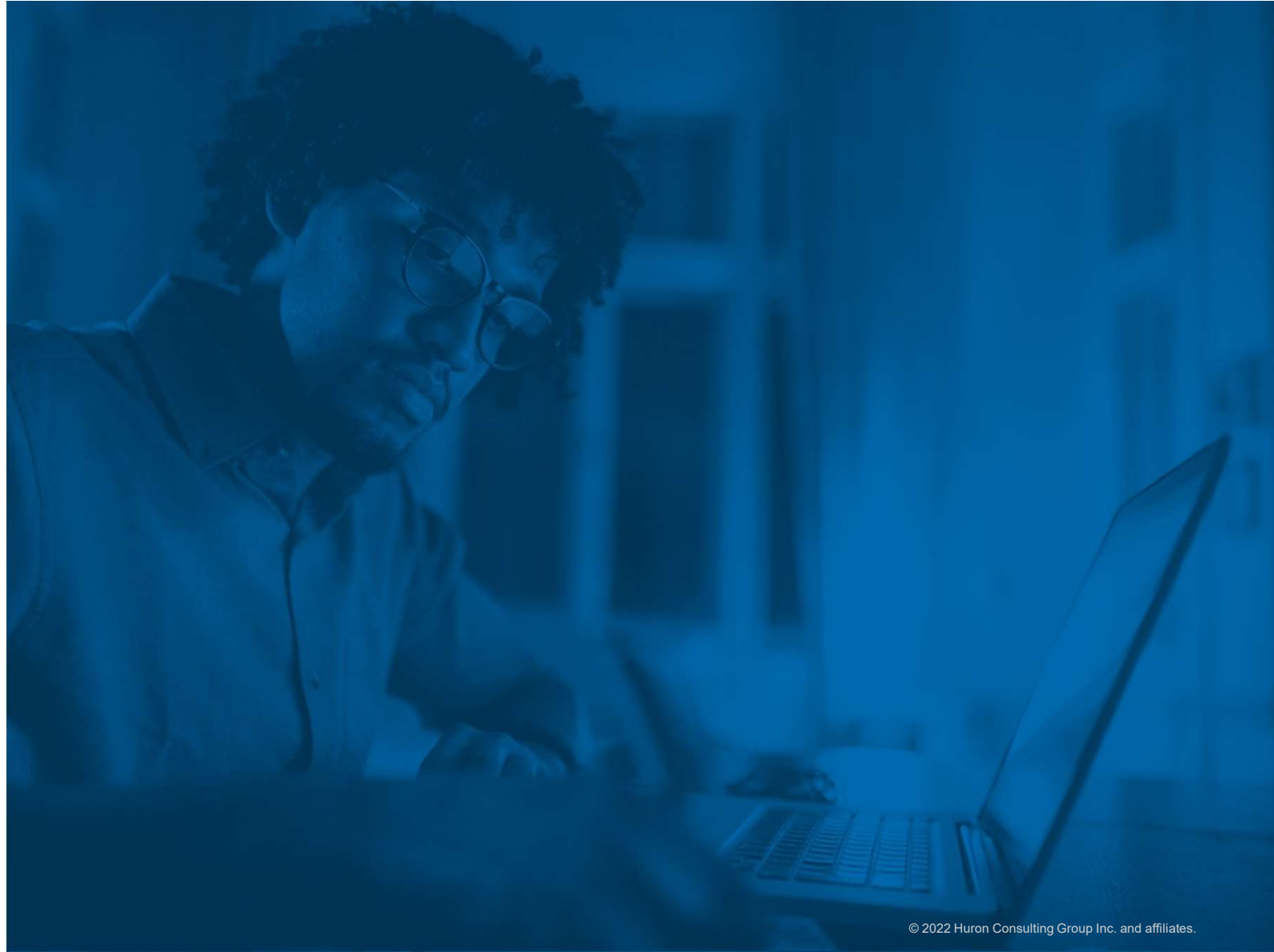

# Leave Policy Standardization

Policy standardization, including policies such as parental leave, vacation accrual, and catastrophic leave, will move USHE closer to industry benchmarks and increase systemwide collaboration.

## Case for Change

- **Rationale:** Conversations with stakeholders revealed that parental leave is unique within each institution and often varies across faculty and staff. This causes difficulties amongst employees when transferring from different institutions and evaluating the variety of benefit offerings. Standardizing would ensure fair competition across the System and avoid employee confusion.
- **Industry Practice:** At the University of Illinois system, faculty and staff are eligible for up to six weeks of paid parental leave which is counted toward the 12-week family and medical leave entitlement.
- **Prerequisites:** Many institutions have unique leave benefits across faculty and staff. In order to establish consistency across the System, policies will need to be standardized first at the local institutional level.

Sources: <sup>1</sup>Parental Leave Policies taken from institution websites

<sup>2</sup>CUPA-HR 2021 Benefits in Higher Education Annual Report

## Percentage of Parental Leave Policy<sup>1</sup>

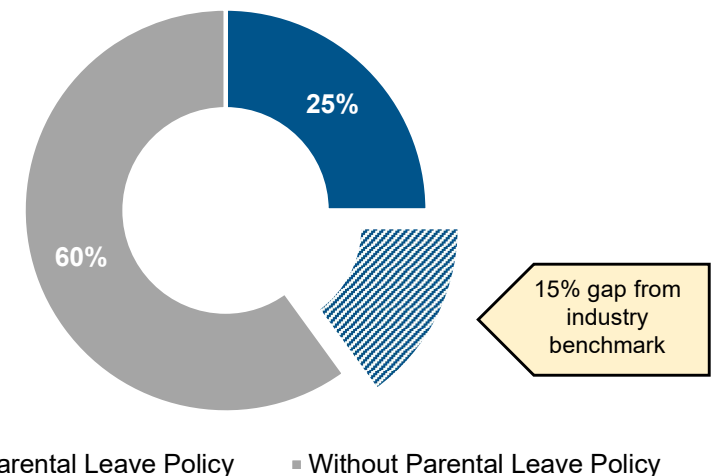

**Around 40% of higher education institutions offer paid parental leave in addition to vacation and sick time.<sup>2</sup>**

# Centralized Recruitment Operations

USHE can ensure consistent and strategic recruitment processes for both the end-user and internal stakeholders through increased centralization and ownership of recruiting operations.

## Case for Change

- **Rationale:** Current USHE Recruitment Operations are decentralized, with only around 30% of operations occurring within the central unit. Distributed recruitment operations results in a deficiency of shared resources across the units and a lack of collaboration. Waning talent pools across the industry impose a need for centralization to ensure a more strategic focus on current processes.
- **Industry Practice:** The University of Wisconsin maintains standardized, centralized recruitment processes to ensure compliance and efficiency.
- **Prerequisites:** The institutions across USHE have unstandardized and distributed recruitment practices. Standardization at the local level would have to be addressed before group level centralization can occur.

## Recruitment Distribution

Recruitment Activity Distribution

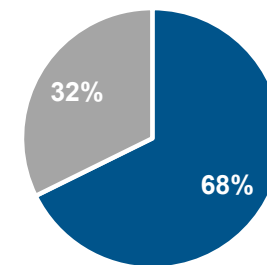

■ Distributed ■ Central

USHE spends \$4.9M on recruitment-related activity

HR Investment by Activity

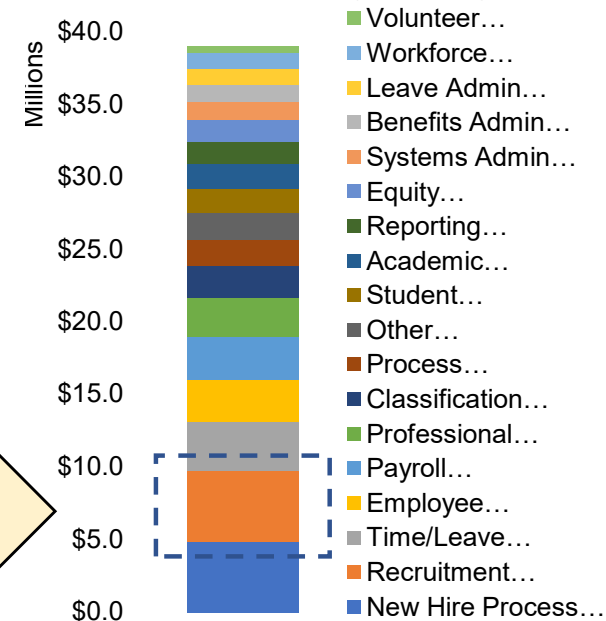

# Increase Managerial Spans of Control

USHE has a high prevalence of supervisors spending the majority of their time doing line work rather than managerial activities. Narrowly focused redesign and role consolidation can improve efficiency.

## Case for Change

- **Rationale:** Broadening spans of control can promote more effective supervision, streamlined processes, and better utilization of resources, which helps to stabilize performance management and minimize title inflation.
- **Industry Practice:** It is generally recommended to reserve one-to-one reporting relationships for exception scenarios, but one possible target is to not exceed 5%.
- **Prerequisites:** In order to accurately monitor the number of one-to-one reporting lines, consistent processes and procedures for maintaining supervisor information would need to be implemented. Roles must be standardized to include well-defined scopes of work and career paths for non-managerial senior staff should be identified.

## Supervising Activity FTE vs. 1:1 Reports<sup>1</sup>

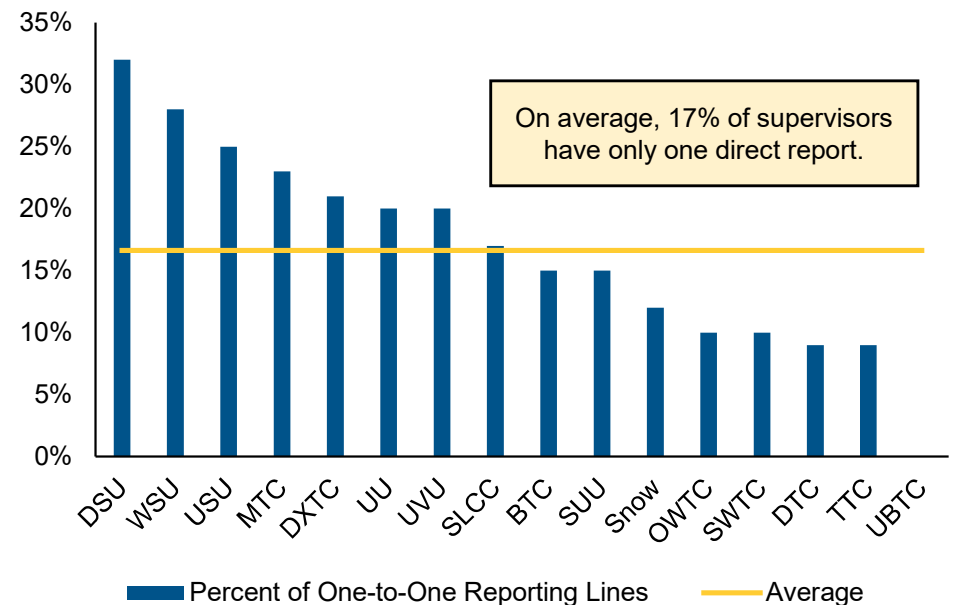

Source: <sup>1</sup>One-to-one reporting lines were obtained from the census files provided by each institution.

# Talent Acquisition Collaborative

USHE can improve talent management with group or systemwide integrated business processes that facilitate retention and provide data for employee acquisition needs.

## Case for Change

- **Rationale:** Market trends have seen a waning workforce which has prompted a need for more collaborative talent and acquisition processing. Implementing a centralized model to support employee transfers across institutions and the maintenance of the existing talent pool will provide a net benefit to the System.
- **Industry Practice:** The University of Oregon established a single central website for job openings throughout neighboring institutions to be used as a resource for individuals looking for employment in a certain area.
- **Prerequisites:** Talent and acquisition is distributed within institutions. Centralization of recruitment operations will need to occur at the local level before a systemwide resource can be implemented.

Source: <sup>1</sup>IPEDS Total Employee Count

## USHE Employee Trends

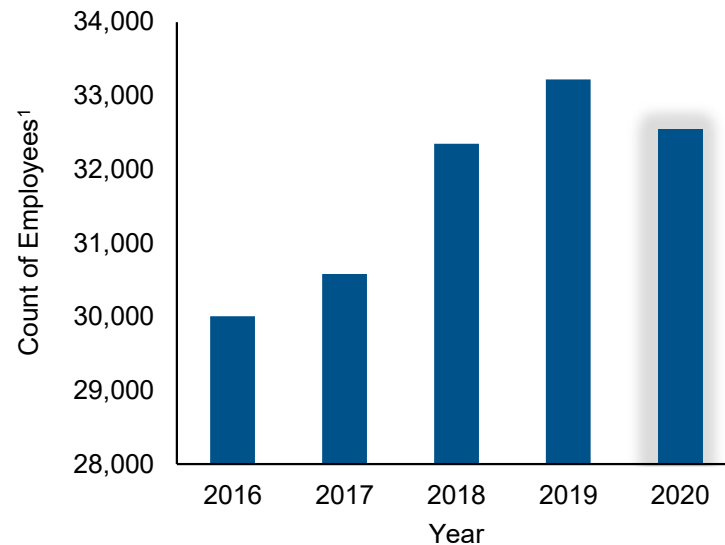

“Great employees are leaving the higher education industry because we don’t have the resources to connect them with other institutions.”

**USHE saw employee growth until 2020, which shows the need to focus on retention strategies to avoid unwanted employee turnover.**

# 2e

---

## Foundational Opportunities

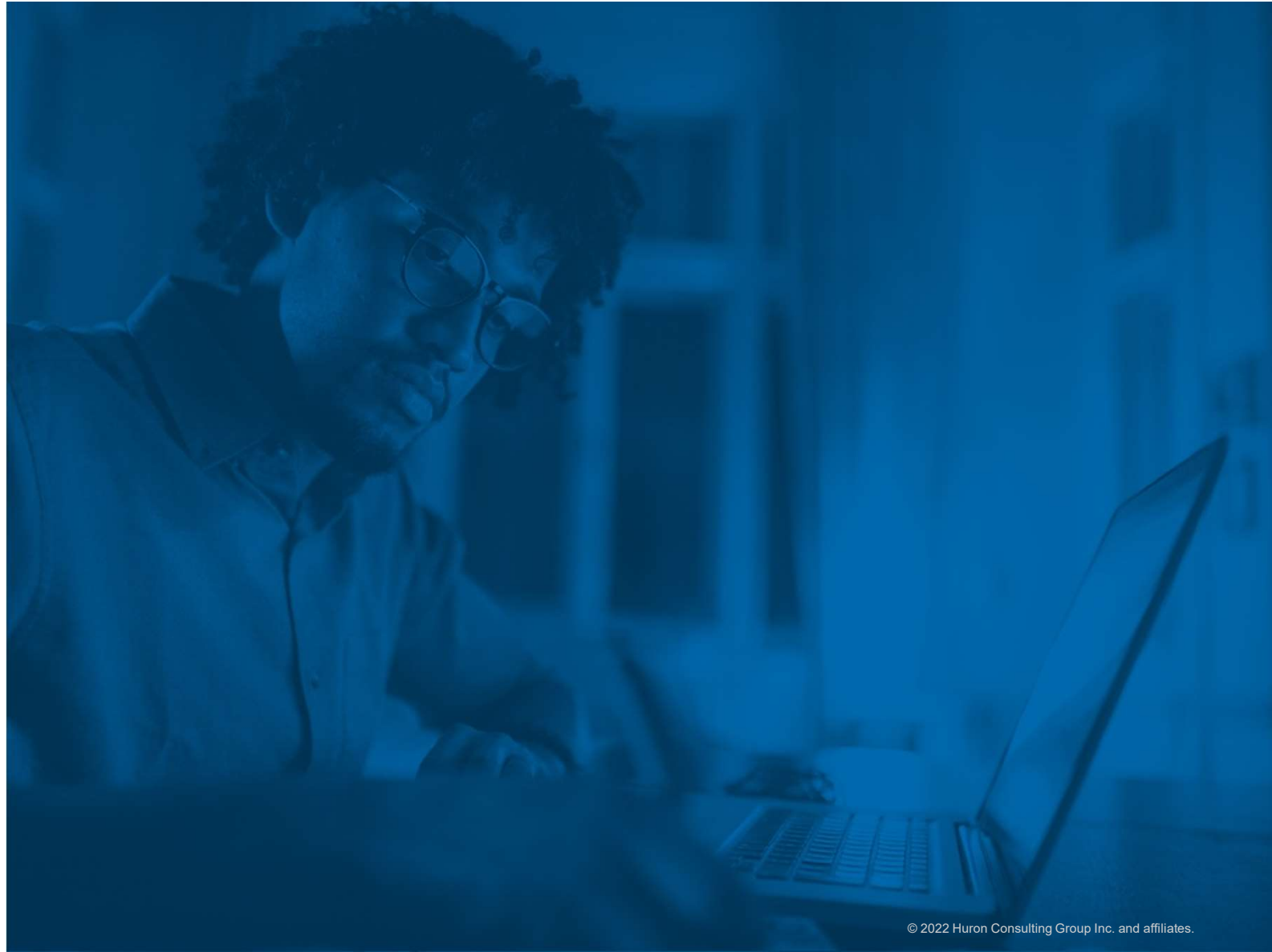



# Foundational Opportunity Overview

Foundational opportunities represent policy, process, or technological initiatives that are necessary and enabling steps for developing more comprehensive systemwide opportunities.

## Foundational Opportunity Areas



**Policies:** When do policies need to be unique and when should they be standardized?



**Processes:** Are current business processes capable of supporting systemwide initiatives?



**Technologies:** What technologies and systems are scalable across the System?

## Example Results



**Finance:** Accounts payable operations, treasury operations, general accounting services, and journal entry processing



**Human Resources:** Payroll services, benefits administration, strategic talent acquisition, management, and new hire processing



**Procurement:** Purchasing and payment services, P-Card management, and increased, streamlined, and standardized purchasing processes



**Information Technology:** Systemwide data analytics and reporting, consistent quality of information security offerings, and support for System provided services

# System Policy Framework

USHE can streamline policies and procedures via a hierarchal framework in order to eliminate redundancy, close gaps, and rectify conflicting policies that cover subsets of the System.

## Case for Change

- **Rationale:** Discrete sets of policies for subsets of the System creates complexity which can lead to confusion, gaps, and contradictory expectations for compliance. For example, institutional governance policies are still split between USHE and formerly UTech institutions<sup>1</sup>.
- **Industry Practice:** The University of Wisconsin System adopted a single policy framework that aligned the institutions within the System, which simplified the policy library and clarified the requirements for compliance.
- **Prerequisites:** Leadership would need to have a mandate to formalize and enforce a single set of policies and procedures for all institutions within the System. Institutions requiring policy adjustments will need to make action plans for addressing these changes.

Source: <sup>1</sup>USHE Policy Website (<https://ushe.edu/policies/>)

## Unified Policy Framework

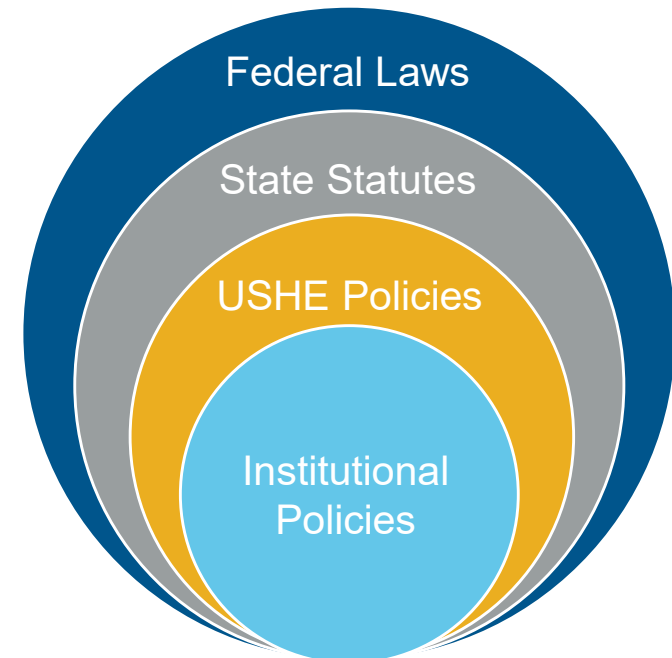

# Standardize Procurement Platforms

Moving procurement services to a common platform at the group or System level will increase the ability to leverage contracts, analyze institutional spend, and provide a more consistent buying experience.

## Case for Change

- **Rationale:** Currently, USHE does not take advantage of shared procurement services. As a result, processes become redundant and expensive. Optimizing technology and services with tools that can be used systemwide will yield more efficient processes and potential cost-savings.
- **Industry Practice:** Multiple institutions and state systems operate with standardized procurement platforms. Such platforms are able to handle core procurement functions such as accounts payable, accounts receivable, and travel & expense.
- **Prerequisites:** Transitioning to a different procurement platform will be a large lift that alters current processes and policies. Ensuring that services align with all institutional missions will assist with getting stakeholder buy-in.

## Procurement Technology<sup>1</sup> Overview

Institution	Finance	Procurement
UU	PeopleSoft	JAGGAER
DTC	Microsoft Dynamics Great Plains	Microsoft Dynamics Great Plains
MTC	Microsoft Dynamics Great Plains	Microsoft Dynamics, AvidXchange
Snow	Banner	JAGGAER
DSU	Banner	Banner
SUU	Banner	Banner
UVU	Banner	JAGGAER
TTC	QuickBooks	QuickBooks
WSU	Banner	JAGGAER
USU	Banner	JAGGAER
SWTC	QuickBooks	QuickBooks
BTC	Jenzabar	Jenzabar
UBTC	Alio	Alio
DXTC	Microsoft Dynamics Great Plains	Microsoft Dynamics Great Plains
OWTC	Sage MAS 500	BP Logix
SLCC	Banner	JAGGAER

Source: <sup>1</sup>Procurement technology from Huron data request 3.01 and 6.05

# Chart of Accounts Standardization

USHE lacks a standardized chart of accounts, which creates disorganized and inconsistent systemwide data as well as a barrier for cross-institution collaboration.

## Case for Change

- **Rationale:** Standardization of institutional chart of accounts will make for easier systemwide collaboration and data collection as well as increase efficiencies within institutions that might not have a structured/strategic chart.
- **Industry Practice:** A public university system uses a standardized chart of accounts structure at all institutions, which allows for uniform reporting for the entire system. The chart is comprised of 7 transferrable account number segments.
- **Prerequisites:** Varying technology and platforms that have in-house customizations along with unique institutional financial needs call for a chart of accounts that is robust enough to adequately capture all necessary information.

## Impact on Data Quality

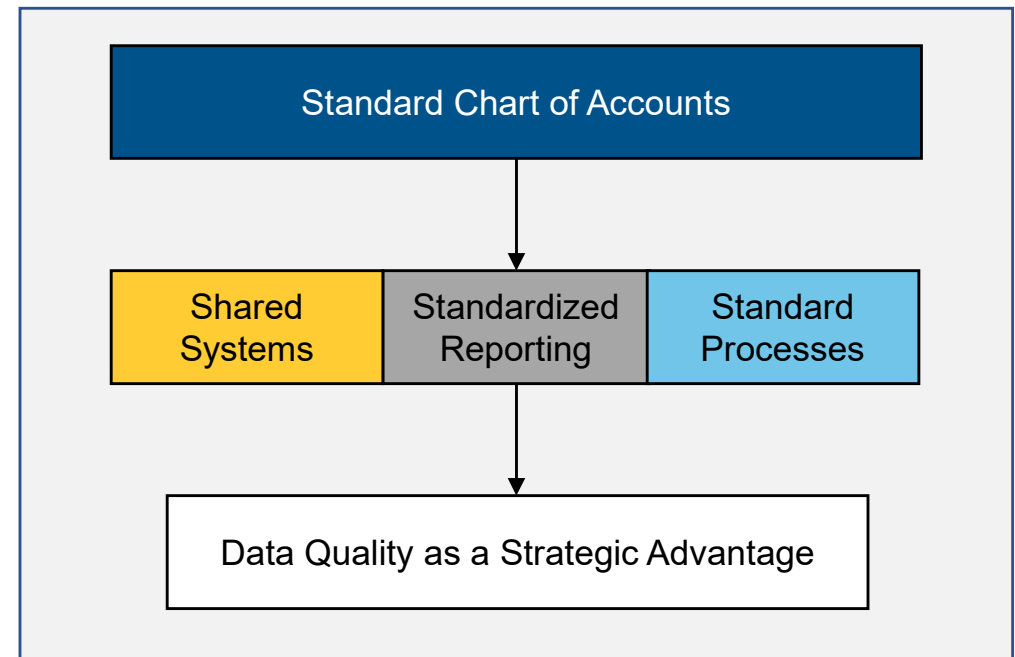

# Compensation & Classification

A compensation & classification study would help create consistency, equity, and improve talent development at USHE institutions.

## Case for Change

- **Rationale:** Compensation & classification was identified as the number one area for improvement in the OFI survey. For example, administrative assistants at UU “wear many hats” and have inconsistent job duties, which can create discrepancies in compensation and equity practices. This finding is mirrored systemwide.
- **Industry Practice:** The University of Wisconsin System is engaged in a redesign of job titles and compensation structures to create relevant and market informed positions that support retention, growth, and equity.
- **Prerequisites:** A successful study requires establishing a project team, balancing institutional needs with best-practices, and employee engagement across the System.

## Role Comparison by Function

Sample of UU Administrative Assistant Job Code<sup>1</sup>

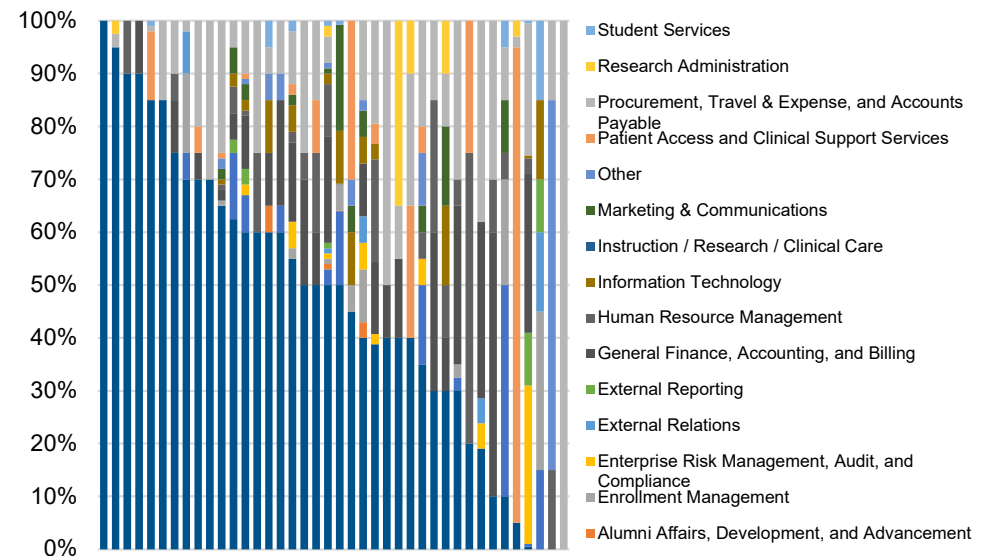

Note: <sup>1</sup>Data represents 40 of 116 administrative assistant positions

# Systemwide ERP

Implementing a systemwide ERP would provide “one version of the truth” across all USHE institutions, allow for business process standardization, and reduce institution-specific technical debt.

## Case for Change

- **Rationale:** Stakeholders identified the absence of standardized processes and systems as a barrier to major opportunities. A standardized ERP would overcome this barrier supporting systemwide cost saving and service improvement initiatives.
- **Industry Practice:** Systems such as Wisconsin, Texas, Penn State and California have implemented shared information services across their institutions, in order to realize efficiencies based on shared resources, hardware, data centers, and governance.
- **Prerequisites:** A common ERP requires coordination between all functional areas across the System to standardize data and have similar, but not identical, processes.

## Institutions & Users<sup>1</sup> per ERP Solution

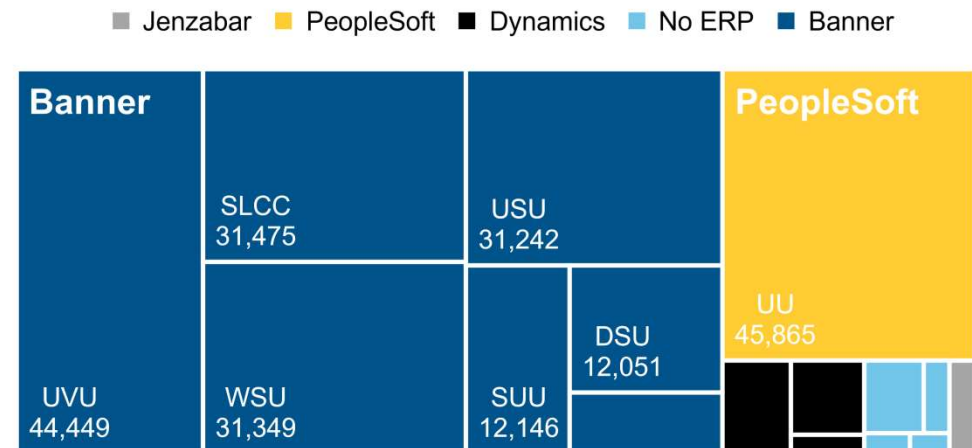

By implementing a systemwide ERP, the benchmark of 30 users per ERP support person at small, and 60 at medium-sized, institutions increases to about 110.

Note: <sup>1</sup>Users include students, faculty, and staff.

# 2f

---

Local  
Opportunities

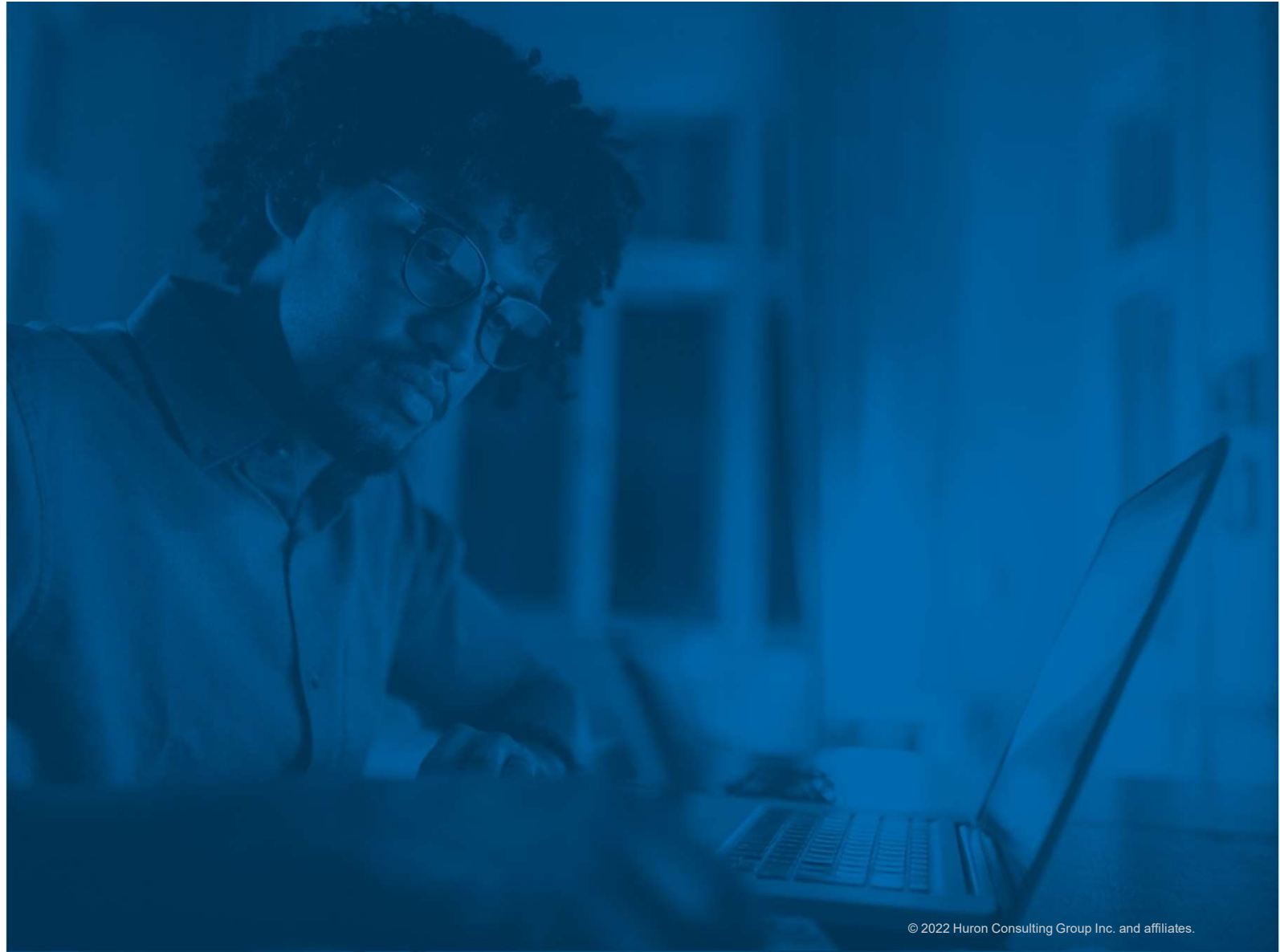

# LOCAL OPPORTUNITIES

While the menu of opportunities includes opportunities applicable at the local level, this set of opportunities narrowed the focus to each USHE institution.

Huron heavily leveraged institutional feedback to ensure that the identified opportunities are reflective of key pain points and/or potential for improvement.

01

## Stakeholder Interviews

Initial insights and target areas were derived from institutional interviews.

02

## OFI Survey results

Insights were supplemented by the identification of high-potential areas for improvement.

03

## Targeted Analysis

Opportunities were then refined using targeted HAAS and supplementary data analysis.



HR
Local

## Embedded HR Model (University of Utah)

The University of Utah currently spends \$20.3M across 191.1 FTE on delivering Human Resources, with just 22% of that effort in the central unit. Centralizing services can reduce costs and decrease risk.

### Case for Change

- Rationale:** The current operating model for delivering HR services at UU allows units to both leverage centralized support for a fee in the “embedded” model and to also create their own HR operations.
  - This distribution creates a duplication of effort, reduces specialization, and creates risk through limited central oversight. Expanding the centralized support counteracts these issues.
- Industry Practice:** Penn State realigned distributed, departmental HR resources into a shared service center to create more efficient and data-driven service, based on industry best practices.
- Prerequisites:** The institution would need to identify the specific HR functions for the central unit to perform and conduct detailed process mapping.

### Distribution of Human Resource Support

FTE Contribution by Division

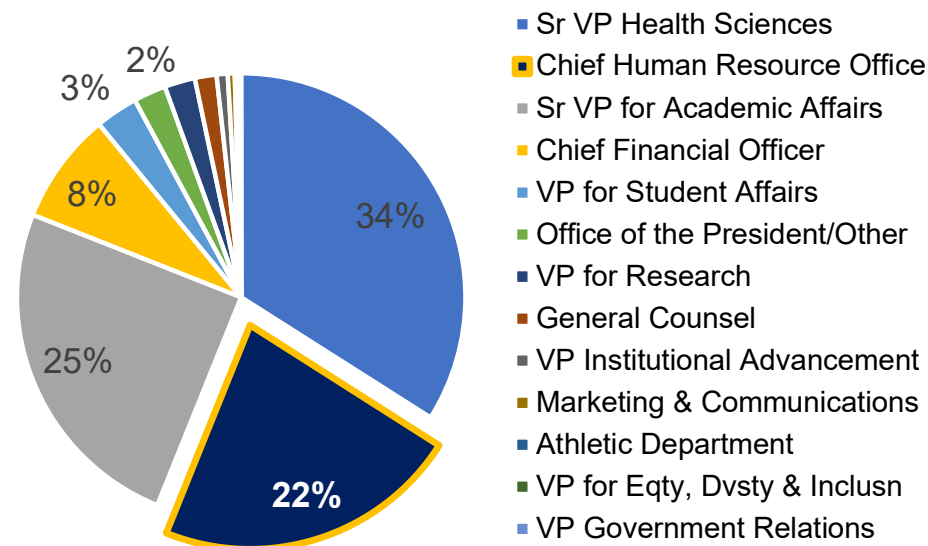

# Academic Advising (University of Utah)

Academic Advising across UU is exceedingly fragmented; individuals who have the same job code have very different job activities. UU should work to standardize roles to increase consistency and equity.

## Case for Change

- **Rationale:** Academic program support is highly distributed across units at UU and Academic Advisors have inconsistent and fragmented roles. Centralization will assist with standardization, create clear role expectations, and ultimately increase efficiency.
- **Industry Practice:** The University of Chicago has a central Academic Advising Office that maintains standardized roles and processes for employees to concomitantly ensure consistency and efficiency.
- **Prerequisites:** Currently, academic advisors are performing multiple activities throughout the institution. Redesign of their roles may create service gaps in other areas of work that would need to be identified and addressed during implementation.

## Sample Academic Advisor Fragmentation\*

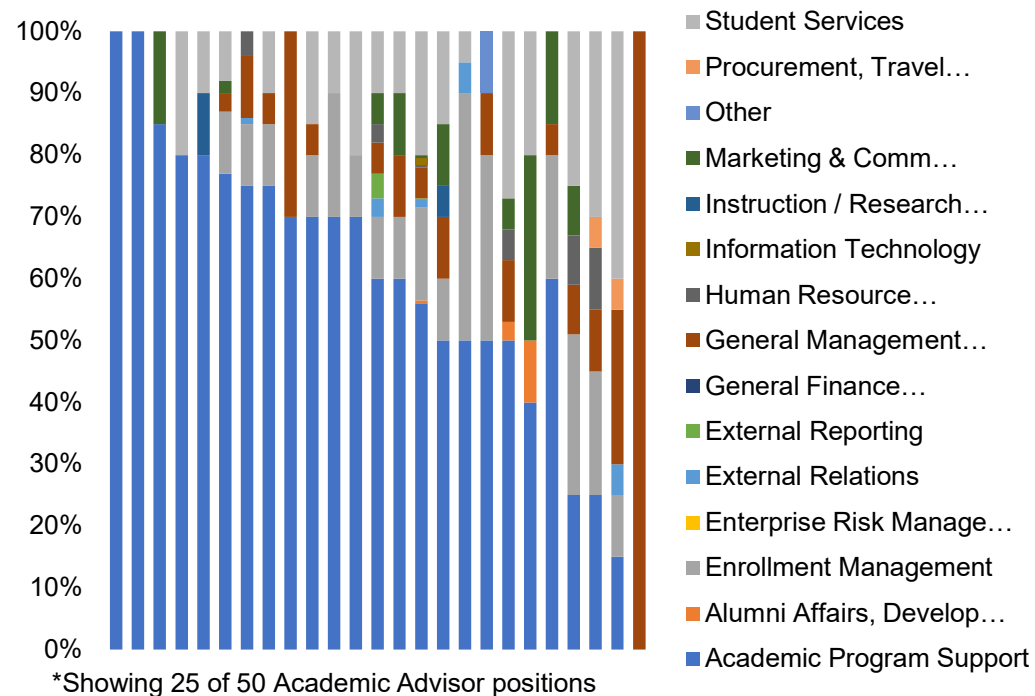

# Increase Centralized Procurement (Utah Valley University)

Utah Valley University procurement activities are performed by generalists with the majority of activity occurring outside the centralized unit. UVU can improve employee efficiency by centralizing activity.

## Case for Change

- Rationale:** The procurement function is supported by fragmented effort, with 93.2% of effort coming from employees spending less than 20% of their time in the area. UVU can reduce the annual \$3.4M expenditure on procurement by increasing the centralization of procurement activities, such as requisitioning or purchasing.
- Industry Example:** USNH Procurement, a system operated unit, manages various steps of the procurement process for the entire system, which includes much of the shopping, requisitioning, and purchasing activities.
- Prerequisites:** Process mapping, policy standardization where applicable, identification of JAGGAER adoption, and a change management plan to increase JAGGAER adoption to balance risk with efficiency will need to occur.

## Procurement Contribution

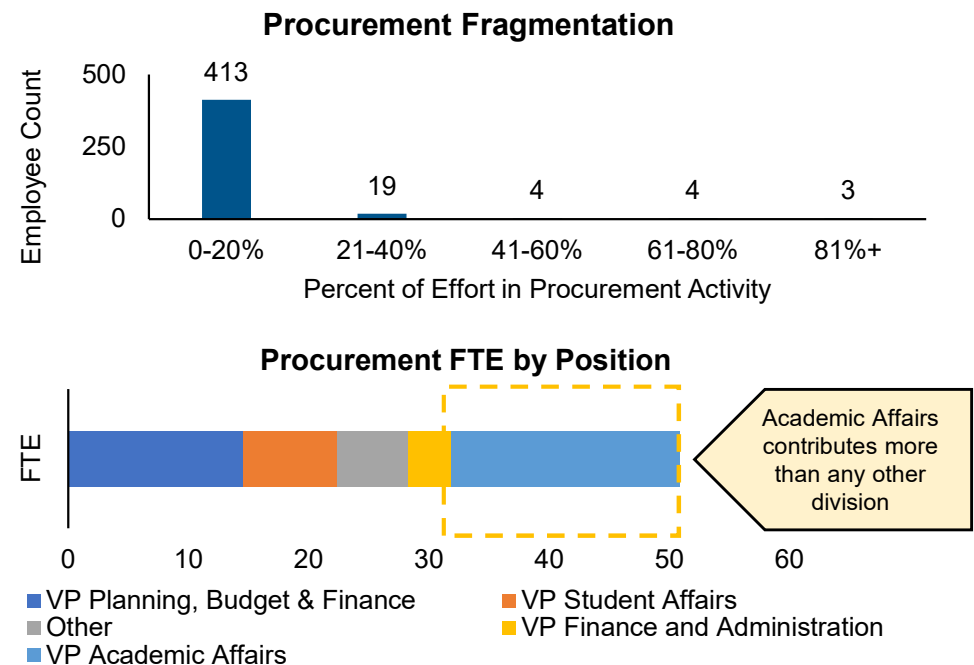

# Centralize Select Finance Activities (Weber State University)

Weber State has the second highest ratio of finance support FTE compared to expenditures, which suggests the opportunity for efficiencies in finance service delivery through centralization.

## Case for Change

- **Rationale:** WSU spends \$4.1M on 55.5 FTE to support finance functions across campus, with over 60% of this effort coming from units outside of Administrative Services. Centralizing specific financial services can help WSU align with peers while increasing service ability.
- **Industry Practice:** The University of Michigan implemented a comprehensive financial shared services center that manages transaction and processing areas related to finance such as accounting, billing and collections, reimbursements, and travel & expense.
- **Prerequisites:** Process mapping and standardization, identification of activities to be performed centrally, and change management are necessary preliminary activities. Additional resources may need to be allocated for any employee or position transitions across the organization.

## Benchmarking and Finance Contribution

Finance FTE to Institutional Expense (Millions)

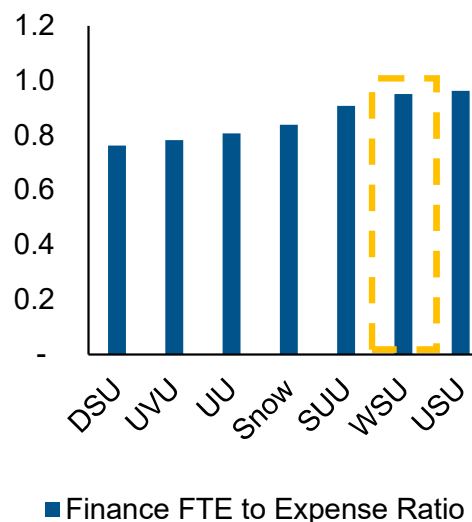

WSU Finance FTE

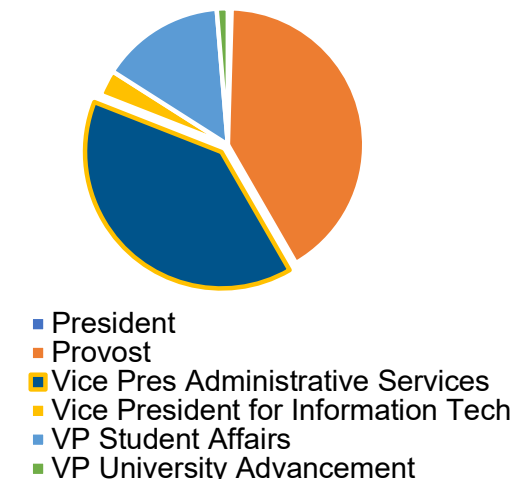

# Project Management Office (Davis Technical College)

Project management is distributed throughout DTC. Establishing a centralized office supports strategic initiatives like the Salesforce implementation or other potential Technical College partnerships.

## Case for Change

- **Rationale:** DTC currently allocates nearly \$250K across 32 individuals to support project management. Given DTC's strategic projects, such as the Salesforce implementation, as well as its position within the technical colleges, establishing a local PMO could contribute success locally and bring expertise in project management to other technical colleges.
- **Industry Practice:** The University of Illinois System manages a PMO that services the entire system in areas such as managing shared resources across the system, training and establishing project management best practices, and monitoring compliance.
- **Prerequisites:** DTC must first establish service level agreements with clear roles and responsibilities across the unit and set a reporting pathway.

## Project Management Support by Division

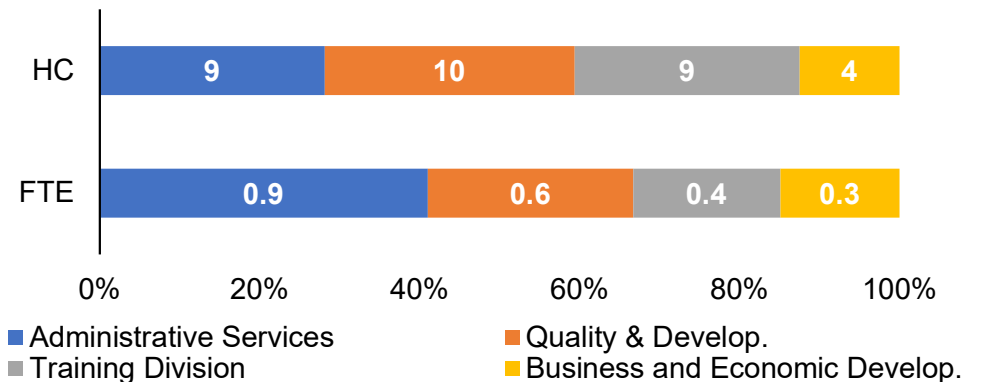

## Project Management Tasks

- Develop project plans
- Track project progress
- Provide updates to leadership
- Develop organizational strategy and implementation plans
- Design and facilitate system, process, or policy improvement initiatives
- Develop and manage change management

## Finance Training (Bridgerland Technical College)

Department heads and director level positions perform over a fifth of all finance duties at BTC. Trainings to increase financial literacy can mitigate risks and increase the quality of financial services.

### Case for Change

- **Rationale:** BTC spends approximately 5.7 FTE on finance related activities, over 20% of which is from 17 department heads and directors who often lack formal finance specialization. Providing trainings to these staff can increase the quality of service and mitigate risk.
- **Industry Practice:** Many higher education institutions either use workshops offered by independent and external organizations, or internal trainings led by their finance divisions.
- **Prerequisites:** Creation of training resources and internal agreement on best-practices will require identifying an individual or team to review existing training materials, if available, develop new ones, and hold scheduled training sessions.

### Finance Contribution

Position Name	FTE	HC
Accountant - Administration	1.00	1.00
Administrative Assistant	0.20	1.00
AR Technician	1.00	1.00
Assistant Registrar	0.25	1.00
AVPs	0.08	2.00
Chief Information Officer	0.02	1.00
Controller	0.50	1.00
Department Heads	0.93	15.00
Directors	0.25	2.00
HR Manager	0.01	1.00
Senior Accountant	0.50	1.00
Specialist – Accounting	0.98	1.00
<b>Grand Total</b>	<b>5.72</b>	<b>28.00</b>

# Standardize & Specialize Roles (Dixie Technical College)

DXTC can increase the specialization of administrative positions through role standardization, particularly the primary in-scope areas of HR, finance, procurement, and IT for improved service quality.

## Case for Change

- **Rationale:** DXTC lacks proficient specialization, as just six of 24 individuals spent more than 20% of effort in a singular activity. Specialization can drive employee efficiency and address some of the bandwidth issues identified during interviews.
- **Industry Practice:** Institutions commonly redefine the roles, responsibilities, compensation, and classifications of employees as they find actual job functions drift from the original job description. Huron has partnered with several institutions to provide this service.
- **Prerequisites:** An understanding of current-state roles and responsibilities, title reviews, and decision-making around which positions should perform specific business processes in the future will need to be established.

## Administrative Fragmentation

Administrative Distribution by FTE

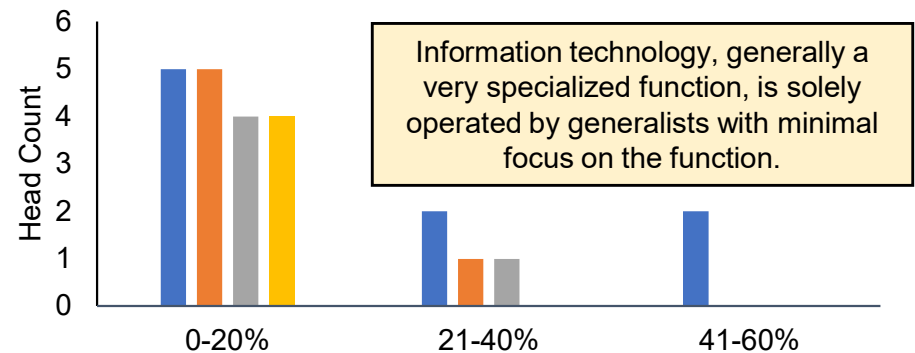

- General Finance, Accounting, and Billing
- Procurement, Travel & Expense, and Accounts Payable
- Human Resource Management (Including Benefits & Payroll)
- Information Technology

# Reporting Relationships (Dixie State University)

DSU has a high volume of one-to one reporting lines, which represents the potential for a more effective reporting structure. A more consolidated structure will allow for reduced cost and increased efficiency.

## Case for Change

- **Rationale:** 32% of reporting lines are one-to-one while supervisors spend an average of 11% of their time on supervisory activities. This prevalence of one-to-one reporting lines increases supervisory costs and limits staff career progression possibilities.
- **Industry Practice:** One-to-one reporting relationships are rarely an optimal use of resources and, in Huron's experience, should not exceed 5-10% for any given institution.
- **Prerequisites:** In order to accurately monitor the number of one-to-one reporting lines, consistent processes and procedures for maintaining supervisor information would need to be implemented. Roles must be standardized to include well-defined scopes of work and career paths for non-managerial senior staff should be identified.

## Count of Supervisors vs. Supervisory FTE

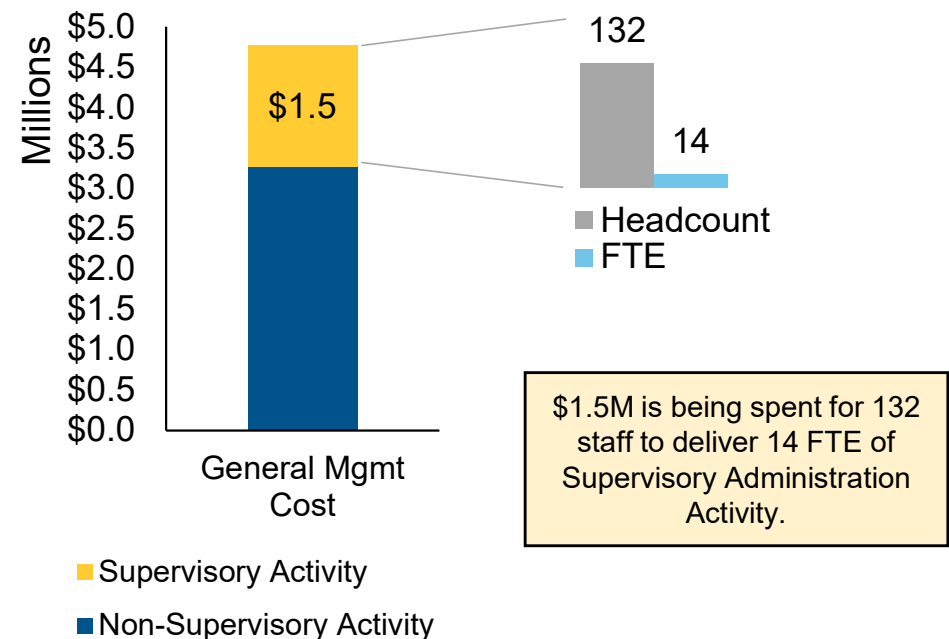



# IT Centralization (Salt Lake Community College)

SLCC can further leverage IT expertise across the whole institution through a centralization effort to break down current silos that may offer varying standards, service levels, and effectiveness.

## Case for Change

- **Rationale:** Roughly a quarter of spending on IT activities is spread out across over 100 staff who are in distributed departments. This suggests that there are opportunities to centralize these activities, which could lead to increased standardization.
- **Industry Practice:** Several colleges have implemented IT shared services by moving all decentralized units to a central IT unit to leverage existing expertise, promote technology standardization, and increase efficiencies.
- **Prerequisites:** Areas that have developed shadow IT staffing to meet niche needs are often reluctant to give those up without a clear plan for how their needs will be transitioned to central IT.

## Distribution of IT Service Effort

IT Headcount

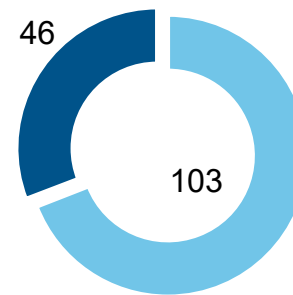

■ Distributed ■ Central

103 distributed staff account for \$0.6M in IT activity spending that is outside of central IT.

IT Expense

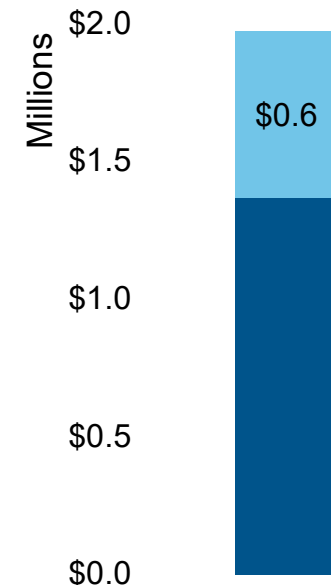

# Database Administration (Southern Utah University)

Creating specialized database administrators can leverage expertise to automate routine tasks, allocate effort to more advanced database administrative activities, and reduce overall expense.

## Case for Change

- **Rationale:** Database administration is currently fragmented across more than 25 employees. By consolidating this effort in a narrower set of specialized staff, SUU can focus its efforts on process improvement and automation.
- **Industry Practice:** Many universities have at least one highly specialized database administrator who either performs all patching and maintenance of databases or leads those efforts.
- **Prerequisites:** Identify the specific database administration tasks that are being performed by staff who are not database administrators and analyze the root cause for the fragmentation. Verify that non-DBA staff should have that level of access to databases.

## Database Administration FTE vs. HC

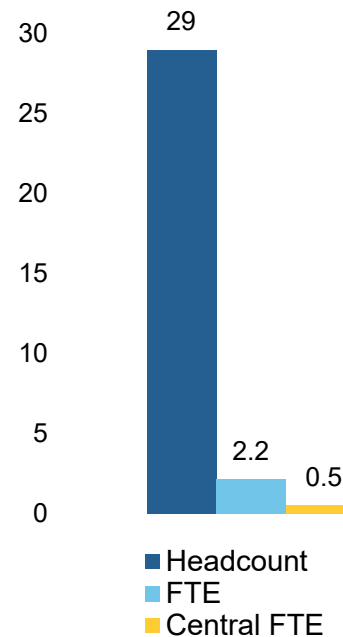

Database administration activity has \$206K in expense, but only 25% of that is from central IT.

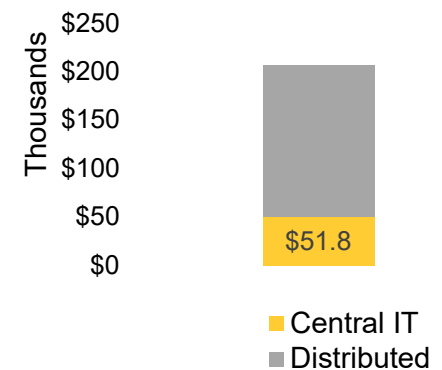

# Project Management Office (Southwest Technical College)

SWTC currently has minimal specialization in project management, which hampers process improvement efforts. Key hires with PM specialization can greatly increase institutional effectiveness.

## Case for Change

- **Rationale:** Interviews indicated that staff are busy keeping operations running which makes long-term projects challenging to execute. A full-time project manager will eliminate these obstacles and free valuable staff capacity for other, mission-critical activities.
- **Industry Practice:** Numerous institutions of all sizes have designated project management activities to an appropriate number of specialists who shepherd key initiatives and increase the success rate for these projects by utilizing standard methodologies.
- **Prerequisites:** Funding for the additional full-time project manager will need to be allocated. Further, adopting industry-standard project management practices often requires a cultural shift to be successful.

## Project Management Activity Metrics

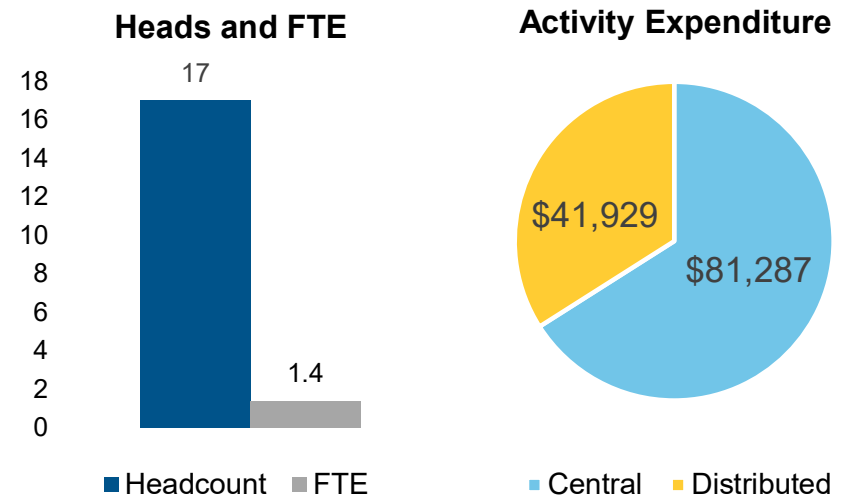

Project Management is fragmented, with \$123K in labor expense for 1.4 FTE spread across 17 staff.

# Procurement Centralization (Uintah Basic Technical College)

Centralized activities will result in standardized understanding and implementation of procurement regulations, which will focus the expertise for these tasks across the institution.

## Case for Change

- **Rationale:** Compared to other procurement activities, those that involve purchasing, receiving, and returning are touched by a high volume of staff. Together, at least 12 staff perform less than 0.5 FTE of activity, which highlights potential risk as well as opportunity for improved service delivery.
- **Industry Practice:** It is standard practice within the industry to centralize procurement processing to ensure compliance with purchasing regulations and increase processing speed.
- **Prerequisites:** Standardizing and automating tasks within a common platform will be critical to successfully centralizing these activities.

## HC vs. FTE for Procurement Activities

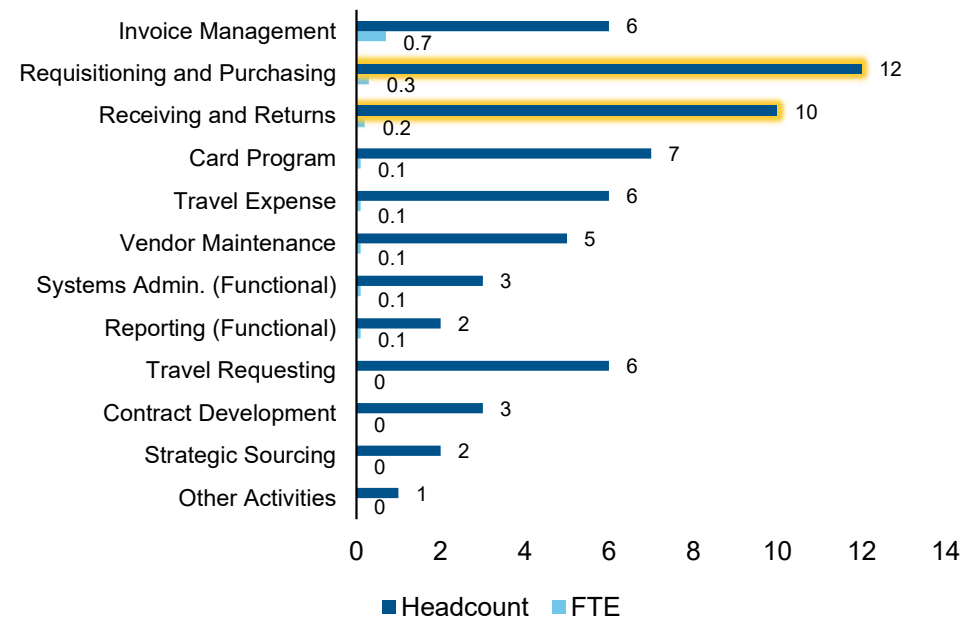

# IT Service Delivery (Utah State University)

Conversations with stakeholders revealed that USU operates with optional central IT services, which has led to distribution. A centralized IT model yields more consistent services and increases satisfaction.

## Case for Change

- **Rationale:** USU dedicates 136.5 FTE to IT, with the central unit contributing 47.8 FTE and departments contributing 89.2 FTE. A centralized IT model emphasizes consistent customer service and proper monitoring of activity, which leads to increased satisfaction and an avoidance of potential security risks.
- **Industry Practice:** The University of Texas Health at San Antonio operates under a centralized IT model with IT partners that act as a means of support for departments.
- **Prerequisites:** Current central IT services are expensive, which leads to many departments deciding to run it in house. Institutional leaders will need to emphasize the importance of risk mitigation and improved service delivery.

## IT Activity Breakdown by Departments

IT Activity Distribution by Departments

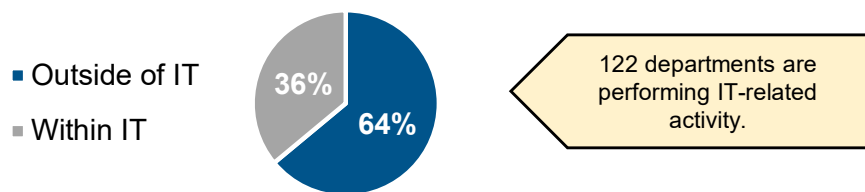

Top Contributors to IT Services

Department	FTE	Percentage of Total IT FTE
Academic & Instructional Services	10.3	8%
Dean of EEJ College of Ed. & Human Services	4.8	4%
USU Blanding	4.8	4%
Dean of University Libraries	4.3	3%
National Ctr. Hearing Assessment & Mgmt.	3.8	3%

# Budgetary Support (Snow College)

Snow’s budgeting and financial management is highly distributed, which results in difficulties providing centralized support. A more centralized model will ensure that departmental needs are met.

## Case for Change

- **Rationale:** Snow stakeholders discussed that there is a gap between the central financial unit and departments, especially as it pertains to budgetary comprehension. Implementing tier 1 support that connects the departments to the central office will assist with communication gaps and increase understanding.
- **Industry Practice:** At the University of Texas Health at San Antonio, a community of financial leaders was developed around budgeting and planning as a means of support for departments.
- **Prerequisites:** Snow is currently undergoing a Chart of Accounts change, which is taking up much of financial capacity. Outside resources will potentially need to be used to implement this support model.

Note: Specialist titles are taken from HAAS data and could exclude employees who perform the same work but did not take the survey

## Budgeting Support Specialization

Generalist vs. Specialist FTE

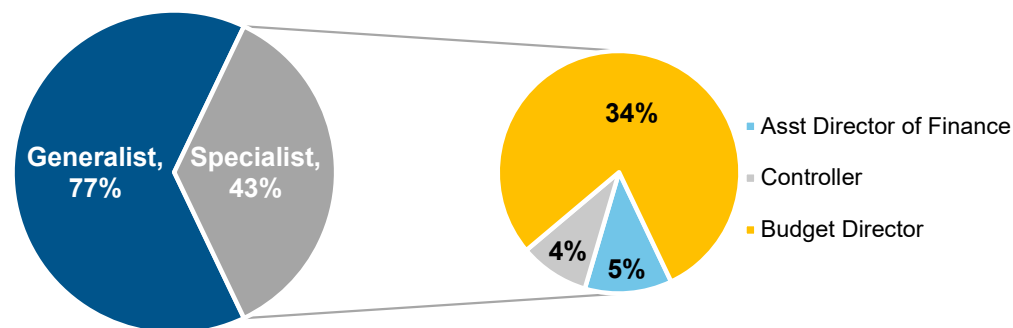

**Only three finance specialists are contributing to budget-related work, which leads to comprehension gaps as individuals without financial expertise perform the activity.**

# IT Investment (Tooele Technical College)

TTC dedicates less than 1 FTE to IT, with 90% of that effort from one individual. Given high reliance on IT services, investing more resources in IT services is required to maintain adequate service delivery.

## Case for Change

- **Rationale:** Stakeholders cited an increased need for IT services due to the College’s growth. TTC should focus on investing in IT service delivery through an increase in resources, process automation, and an increase in collaboration when appropriate.
- **Industry Practice:** Institutions have moved to more automated processes in order to increase efficiency and create more time for collaboration to combat industry trends of a waning workforce and outdated technology.
- **Prerequisites:** To reinvest in IT-related activities, TTC will require a detailed plan and approach to ensure processes are appropriately defined and funneled through any new hires.

## Employee Investment in IT

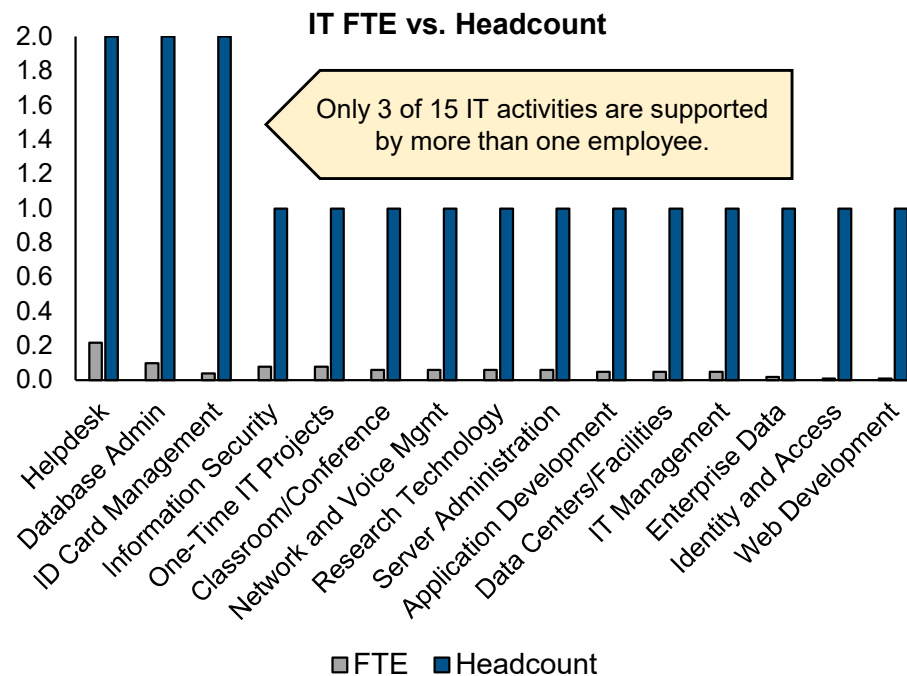

# Transactional Activity (Mountainland Technical College)

Distribution of financial tasks has resulted in employees performing activity that falls outside of their responsibilities. Centralization and specialization will avoid resource overuse and increase capacity.

## Case for Change      Managerial Time in Financial Activity

- **Rationale:** Senior-level employees are spending almost half of their time performing transactional activities, particularly accounting transactions. Centralizing finance will ensure that transactions are properly reviewed, which increases capacity for managers to allocate their time to managing and strategic planning activities.
- **Industry Practice:** The University of Kansas sought shared services related to finance to enhance transaction-based activities and increase capacity.
- **Prerequisites:** Much of the transactional work is being performed by senior-level employees due to the lack of resources within MTC. Proper training is essential to ensure appropriate use of resources and to gain stakeholder buy-in.

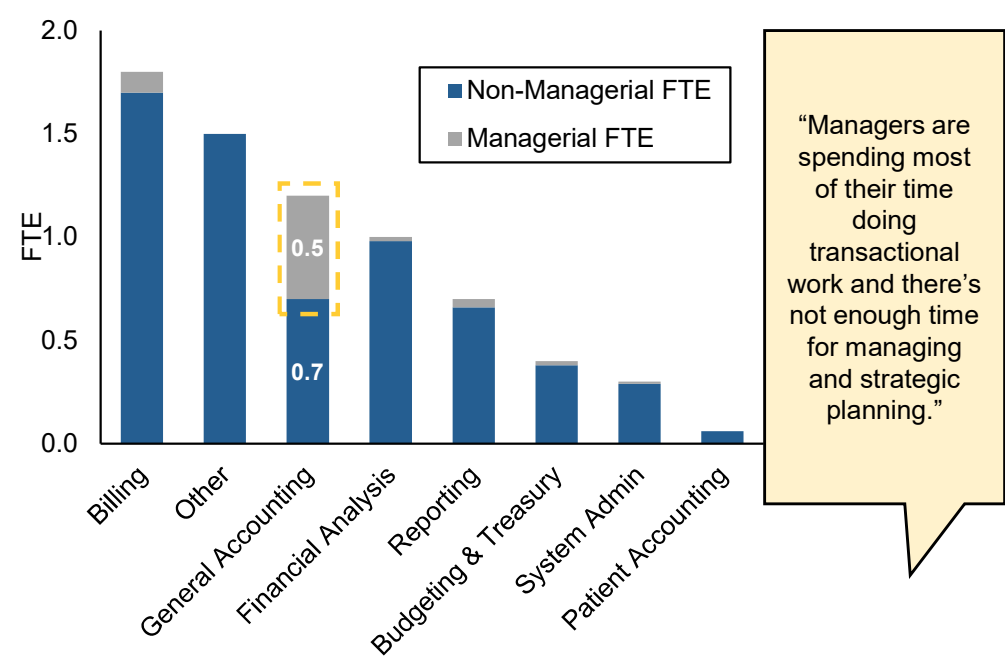

Notes: Senior-level employees were identified based on a titling analysis of key supervisory terms (e.g., Director)



# Finance Specialization (Ogden-Weber Technical College)

Budgeting and financial analysis & planning are largely performed by unspecialized employees. Adding expertise through a dedicated position would increase service capabilities.

<b>Case for Change</b>	<b>Budget and Financial Analysis Support</b>
------------------------	--

- Rationale:** Budgeting and financial analysis & planning, two functions that are typically specialized, are performed without dedicated support, with just one employee spending more than 0.2 FTE in the areas combined. Either adding or redesigning the role of one position can add expertise to tactical financial functions.
- Industry Practice:** Budget and financial support specialists are common positions in higher education that institutions rely on for strategic decision making and analysis.
- Prerequisites:** A dedicated team member would be assigned specific areas of support. Additional process mapping and standardization can occur as needed to streamline and improve existing processes.

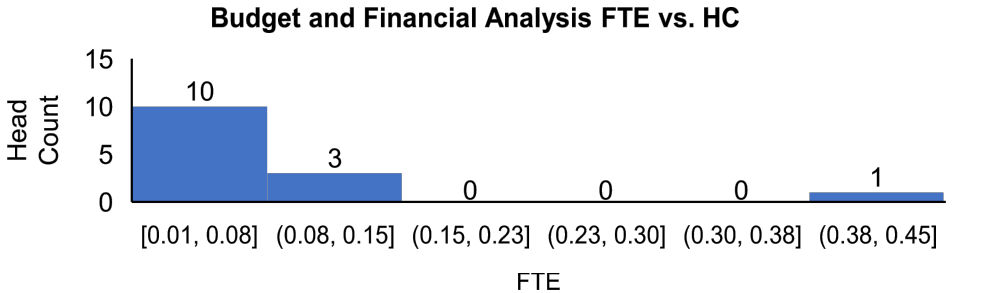
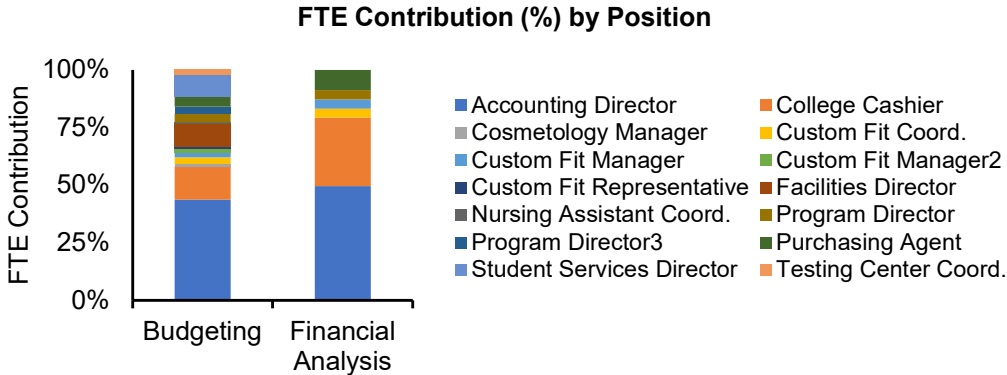

# 3

---

## Organizational Risk & Readiness Assessment (ORRA)

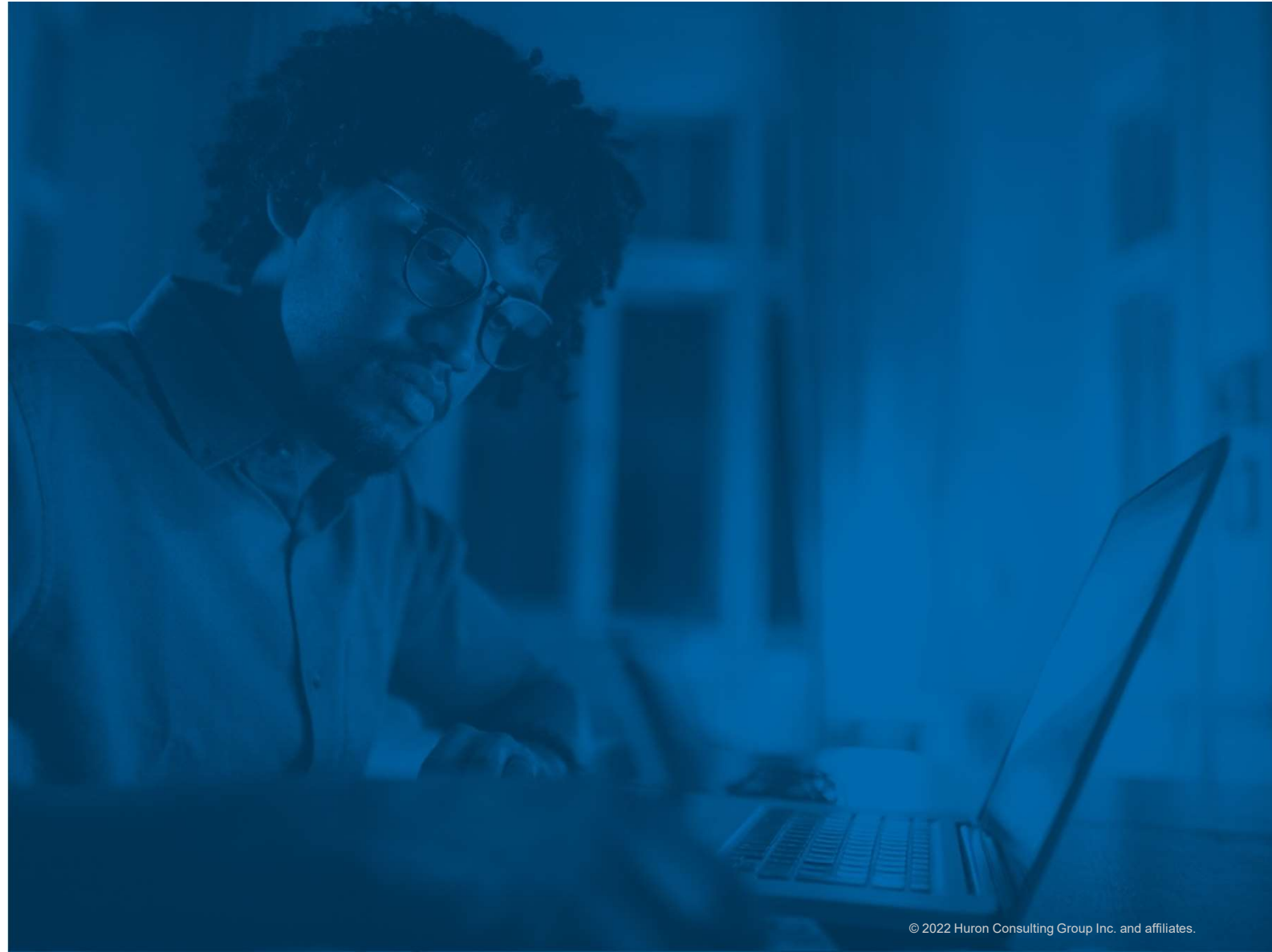

# Change Themes & Insights

Through the Study's stakeholder engagement and analysis, Huron has identified a set of foundational themes and insights that help describe USHE's current perspective on change.

## Staff Capacity

### 1. Limited Staff Capacity

- In stakeholder discussions, USHE staff noted that capacity is particularly tight and resources are strained.
- Limited capacity can create obstacles to change efforts, both in terms of having available resources to support 'the work' and maintaining the cultural commitment to implementing the change.

## Shared Structures

### 2. Gaps in Collaborative Infrastructure

- While there are select examples of shared, systemwide infrastructure, USHE stakeholders noted that there is still a need for more mature, integrated governance to manage systemwide efforts.
- A lack of clear ownership and collaboration can impact transparent accountability for change efforts.

## Distinct Cultures

### 3. Strong Institutional Cultures

- USHE stakeholders highlighted that there are strong institutional cultures but not necessarily a consistent systemwide culture that spans multiple institutions.
- For multi-institution efforts, it is critical to build a shared culture that can serve as the core vision of the initiative.

# Facilitated ORRA Discussion

Huron utilizes the Organizational Risk & Readiness Assessment (ORRA) to develop a comprehensive understanding of the core elements that impact change readiness.

## PAST EXPERIENCE

- Which major changes in the past influence our future changes? How do those experiences influence our ability to change?

## COMMUNICATION

- What aspects of our communication and collaboration influence our ability to change? Can we communicate effectively?

## CULTURE

- What beliefs, behaviors, and norms do we have that influence our ability to change? How do we think and act about change?

## PRIORITIES

- How do our priorities influence our ability to change? Do we have clear priorities?

## ACCOUNTABILITY

- What practices around identifying, assigning, and supporting accountability influence our ability to change?

## ALIGNMENT

- What aspects of our structure and decision-making practices influence our ability to change? Are we organized to change?

## PREPAREDNESS

- What talent (or talent gaps) do we have? How are our resources prepared (or not prepared) to drive change?

# 4

---

## Next Steps

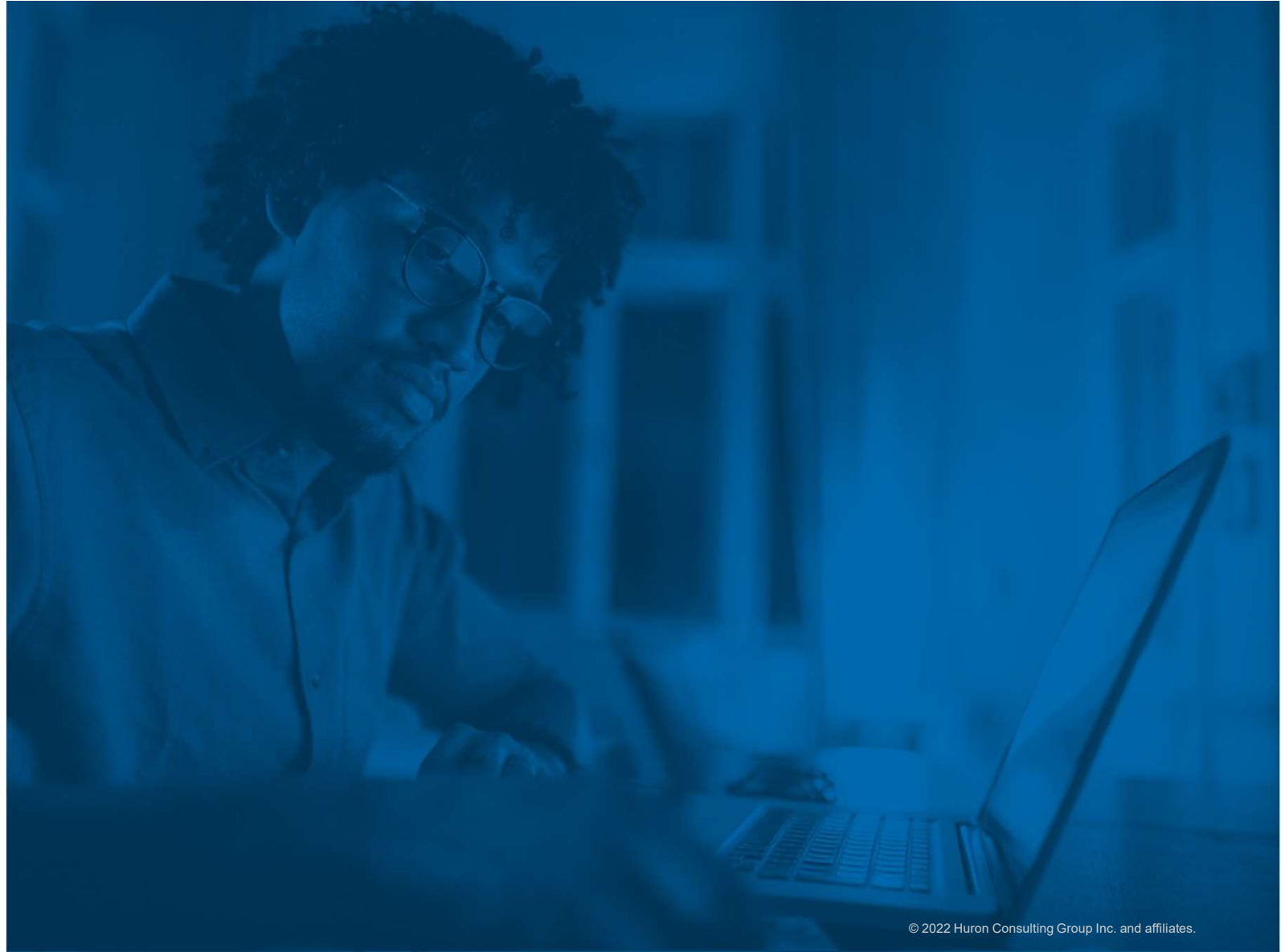

---

## Next Steps

With Phase 2 complete, the USHE Shared Services Study will now narrow the focus to a select set of detailed cost benefit business cases, as well as provide institution-specific analysis.

- **Cost-Benefit Analysis:** Huron will develop business cases centered around high-potential opportunities, which will include details of the potential benefit (financial, operational, etc.) as well as key prerequisites and/or trade-offs required for implementation
- **Institutional Insights:** As a component of Phase 1 & 2 analyses, Huron is developing institution-level packets, inclusive of core HAAS insights and institution-specific opportunities derived from data analysis and stakeholder feedback

# A

---

## Appendix A: Environmental Scan

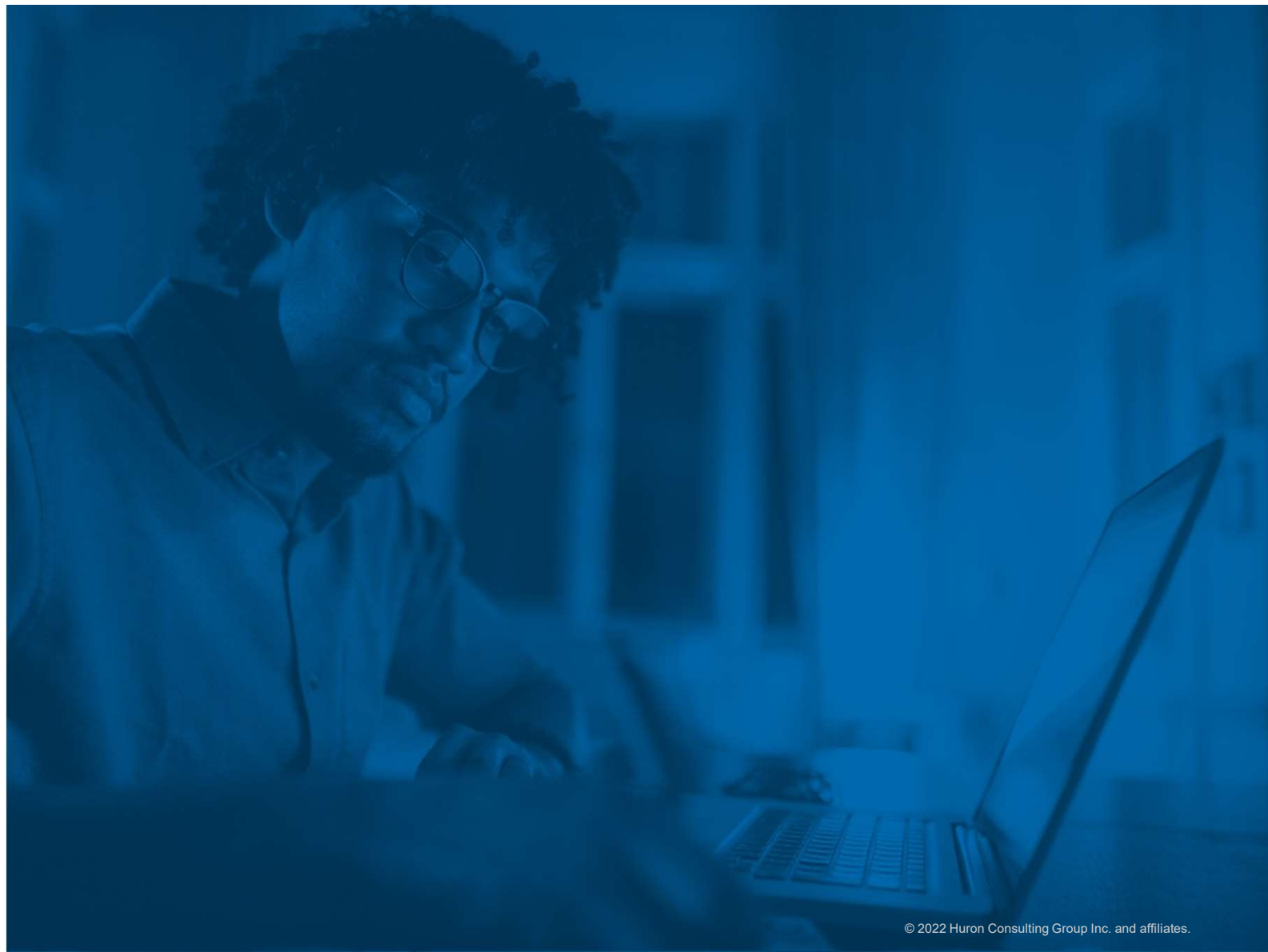

# National Market Trends

Huron performed an external scan to identify key trends in higher education that, among other drivers, have led state systems to look towards shared or collaborative operations.



## Enrollment

- The COVID-19 pandemic saw that enrollment declined across the industry, with some of the lowest numbers in a decade. This downward trend is likely to continue until the state of the virus finds some sort of stabilization.



## Nature of Post-Secondary Education

- Successful remote-learning outcomes has led to an increase in hybrid classrooms.
- The cost of attending college continues to rise, causing families to contest the value of higher education.



## Workforce

- The US economy is experiencing disruption as a result of the pandemic, as well as other factors including technology, automation, and internationalization.
- Working remotely has led to many employees choosing to live outside of their employed state.



## External Funding

- State funding for higher education has increased but has yet to recover from the cuts made during the last recession.
- State-funded support leans towards bigger institutions, with four-year institutions receiving \$6,800 more per FTE than two-year institutions.<sup>1</sup>

<sup>1</sup> Inside Higher Ed Statistics, 2021



# Shared Service Insights

Based on this scan, Huron has identified specific insights that speak to the motivation and benefits that university systems seek by moving towards a shared service model.



## People

Higher education institutions typically implement shared services to better support their employees through the standardization of responsibilities, more robust training, and the avoidance of additional and repetitive effort. As a result, employees feel valued and are better able to perform their duties.



## Risk Mitigation

State systems often move towards shared services as a means of standardizing processes and policies. This ensures compliance and minimizes the risks that can arise in a more distributed operating setting that contains inconsistent and unstandardized practices.



## Cost Avoidance

Peer state systems often provide shared services to cut potential costs. In doing so, institutions have more resources to dedicate to changing industry trends, such as a decreased work force, a call for more hybrid education, and a push for better student-driven services.



## Process Improvement

Conversations with USHE stakeholders revealed that multiple processes are often outdated and redundant. Trends across state systems show that shared services results in more efficient processes, allowing institutions to focus on more mission-driven activity rather than administrative functions.

# University System of New Hampshire

## Overview

The University System of New Hampshire (USNH) implemented systemwide financial, research administration, and human resources shared services center in 2021. With procurement and information technology already centralized, these initiatives allowed USNH to operate in a highly collaborative, shared environment across all major functional areas.

## Goals/Drivers

USNH had been trending towards shared services over the last decade but increased its pace in 2020, partially due to the impact of COVID. The new SSC both increased efficiency and lowered costs systemwide.

## Key Takeaways

- Transactional support can be centralized across distinct institutions but must be cognizant of the uniqueness of each institution
- Broad and detailed stakeholder engagement is key to a successful change process

## About the University System



Enrollment	Faculty	Staff
~30,000	1,175	6,000
Budget	Control	Carnegie Class
\$855 million	Public	N/A

# University of Maine System

## Overview

The University of Maine System (UMS) has a range of shared, systemwide functions, including the management of strategic procurement activities. The UMS System Office oversees all purchasing functions, including accounts payable, sourcing, travel, and compliance, and provides customer service systemwide. UMS sought shared accreditation in 2020 to decrease barriers to collaboration.

## Goals/Drivers

The University of Maine System pursued shared services as a means of increasing process efficiencies across its 8 institutions as well as securing cost savings.

## Key Takeaways

- Governance and other structural barriers like accreditation can be major variables in the success of a shared initiative
- Securing early wins (ex: procurement) is essential to success

## About the University System



Enrollment	Faculty	Staff
~30,000	2,150	3,350
Budget	Control	Carnegie Class
\$3.3 million	Public	N/A

# University System of Georgia

## Overview

The University System of Georgia's (USG) Shared Services Center (SSC) provides functional and transactional support in HR and payroll across the System's 26 institutions. More specifically, this support involves streamlining processes, monitoring and managing compliance risks, and allowing institutions to better focus on student-driven activities.

## Goals/Drivers

The SSC was implemented to drive USG's 26 institutions to be more efficient and accessible by centralizing and standardizing certain administrative functions.

## Key Takeaways

- Developing a leadership body with institutions from across the state system is essential in gaining buy-in from internal stakeholders
- Centralized processes should consistently be updated and defined

## About the University System



Enrollment	Faculty	Staff
~340,000	12,272	53,743
Budget	Control	Carnegie Class
\$7.6 billion	Public	N/A



# University of Michigan

## Overview

The University of Michigan (U-M) implemented shared services to decrease administrative burden from faculty and staff. The SSC supports HR and finance, with a focus on innovative strategies, practices, and approaches related to transaction processing. Since implementing the SSC, U-M has continuously looked to update and expand their offerings, with a recent reorganization in 2021.

## Goals/Drivers

The University of Michigan sought shared services as a means to increase efficiencies and build a more customer-centric strategy across their three campuses.

## Key Takeaways

- Developing a user-friendly web-page increases customer satisfaction
- Inquiries and/or feedback should always be looked at as a learning opportunity for better service delivery

## About the University



Enrollment	Faculty	Staff
~68,500	7,000	26,500
Budget	Control	Carnegie Class
\$4 billion	Public	Doctoral

# State University of New York (SUNY)

## Overview

SUNY implemented a Security Operations Center (SOC) that provides expertise, training tools, and resources around information security to the 64 institutions within the system. Institutions can partake in two services: Base Membership, which is offered to all institutions, and A La Carte, which provides additional services that go beyond base services at an additional cost.

## Goals/Drivers

The SOC was developed to provide all institutions with cost-effective tools and services, a community of practice, an objective view for information security ideas and initiatives, and a centralized perspective.

## Key Takeaways

- Establishing a governance structure that involves a broad array of stakeholders ensures accurate representation across the system
- Cost tiers can create increased participation from all institutions

## About the University System



Enrollment	Faculty	Staff
~350,000	15,000	60,000
Budget	Control	Carnegie Class
\$11.9 billion	Public	N/A

# University of Wisconsin System

## Overview

The University of Wisconsin System (UW) shared services support HR, procurement, and service operations. More specifically, the services provide leadership, guidance, functional expertise, policy development, payroll, and benefits support. UW implemented this model in 2020, rolling it out to 26 institutions.

## Goals/Drivers

The University of Wisconsin System strove to increase administrative efficiencies and service delivery through better supported HR, payroll, benefits, business services, and reporting services.

## Key Takeaways

- Creating a website for systemwide communication ensures that stakeholders stay up to date and understand service offerings
- Creating functional specialization supports system-wide standardization and collaboration

## About the University System



Enrollment	Faculty	Staff
~190,000	8,000	33,500
Budget	Control	Carnegie Class
\$4.8 billion	Public	N/A

# University of Kansas

## Overview

The University of Kansas (KU) implemented shared services related to HR and finance. Within HR, the services support recruitment, onboarding, appointment maintenance, time review and GRA/GA appointments. While in finance, the services support travel and expense, procurement/AP, candidate and honorarium, tuition and scholarships, and deposits.

## Goals/Drivers

KU sought shared services to enhance transaction-based activities by providing more timely and accurate service across the institution's five campuses.

## Key Takeaways

- It's essential to have an initial identification of needs in order to tailor the design to an institution
- Clear communication and cooperation maintains overall satisfaction

## About the University



Enrollment	Faculty	Staff
~28,000	3,000	9,000
Budget	Control	Carnegie Class
\$1.1 billion	Public	Doctoral



# Ohio State University

## Overview

Ohio State University's (OSU) Office of Academic Affairs (OAA) provides direct support through four core shared service areas: fiscal services, HR, IT, and communication. The staff within these areas support internal operations and key partnerships throughout the university, increasing efficiencies through faster processing and service request response rates.

## Goals/Drivers

OSU sought shared services to leverage greater economies of scale, realize meaningful cost savings, mitigate compliance risk, and improve career progression options for employees.

## Key Takeaways

- Shared Service Centers can be cross-functional in nature
- Niche compliance can be better maintained via centers of expertise rather than broader shared service centers

## About the University



Enrollment	Faculty	Staff
~60,000	6,500	35,000
Budget	Control	Carnegie Class
\$3.2 billion	Public	Doctoral

# University of California, Berkeley

## Overview

In 2015, the University of California, Berkeley implemented shared services to replace their highly decentralized model. Berkeley launched a single regional center providing HR, IT, research administration, and finance support for the units. The University saved approximately \$15M after the centers were fully implemented.

## Goals/Drivers

The University sought shared services to reduce redundancy, increase staff development opportunities, streamline rogue policies and procedures, and clarify staff roles.

## Key Takeaways

- Implementation support services are critical in supporting departments in any necessary internal reorganization
- Financial incentives at the unit level increased buy-in and support

## About the University



Enrollment	Faculty	Staff
~42,000	3,000	12,000
Budget	Control	Carnegie Class
\$3 billion	Public	Doctoral

# University of California System

## Overview

The University of California System (UC System) has implemented numerous shared service centers that range in scope and function. Some shared services are limited to their local institution while some support the entire ten campus system. The UiPath Center manages payroll and HR across the system, UC Santa Cruz has their own IT SSC, and UC Recruit supports faculty recruitment across the system.

## Goals/Drivers

The UC System sought shared services to develop more efficient, cost saving processes that would result in better collaboration both at the institution and system level.

## Key Takeaways

- Implementing shared services at the institution level serves as an effective “test-run” for the system-level integration
- Systemwide common business process create new opportunities

## About the University System



Enrollment	Faculty	Staff
~280,000	20,000	106,000
Budget	Control	Carnegie Class
\$41.6 billion	Public	N/A

# University of Missouri System

## Overview

The University of Missouri System implemented shared services to support their finance and procurement functional areas, with a specific focus on Accounts Payable. These services provide transactional processing support across the four campuses that make up the state system. Such transactions include PO vouchers, Non-PO vouchers, travel and expense, and suppliers.

## Goals/Drivers

Shared services were sought to provide human capital and systems that ensure payments are made in a timely, accurate, and compliant manner so that the System's departments can focus on mission-driven work.

## Key Takeaways

- Providing an estimated time frame for specific transactions assists with buy-in from stakeholders
- 'FAQs' and 'How To' aids avoid customer frustration and confusion

## About the University System



Enrollment	Faculty	Staff
~80,000	3,200	160,000
Budget	Control	Carnegie Class
\$1.8 billion	Public	N/A

# Connecticut State Colleges & Universities

## Overview

The Connecticut State Colleges and Universities (CCSU) delivers HR via shared services across its 17 recently merged community colleges and four-year institutions. More specifically, the services focus on providing the following HR services: onsite assistance to employees, labor relation guidance and development, classifications, compensations, benefits, and recruitment and talent acquisition.

## Goals/Drivers

The shared services are delivered through a Center of Excellence (COE) model, with a focus on driving operational improvements and promoting a culture of continuous growth and development.

## Key Takeaways

- Standardization of policies and processes assists with maintaining cultural balance across diverse institutions
- Clear and efficient service delivery ensures understanding

## About the University System



Enrollment	Faculty	Staff
~105,000	2,000	10,000
Budget	Control	Carnegie Class
\$1.3 billion	Public	N/A



# University of Illinois System

## Overview

The University of Illinois System established a Business Shared Service Center that provides a pool of staff with expertise on administrative areas. The areas of service within the SSC include business/finance solutions, instructional design, ability LMS support, online conference and events, change management, communications, project management, and process improvement.

## Goals/Drivers

The goal of the services was to provide expertise that surpasses what is available within the units, establish a support structure, and provide processes and methods that have been proven in the environment.

## Key Takeaways

- External expertise ensures that processes are efficient and reliable across the system
- Shared resources can elevate service delivery universally

## About the University System



Enrollment	Faculty	Staff
~100,000	5,000	27,000
Budget	Control	Carnegie Class
\$4.4 billion	Public	N/A

# B

---

## Appendix B: Phase 1 Report

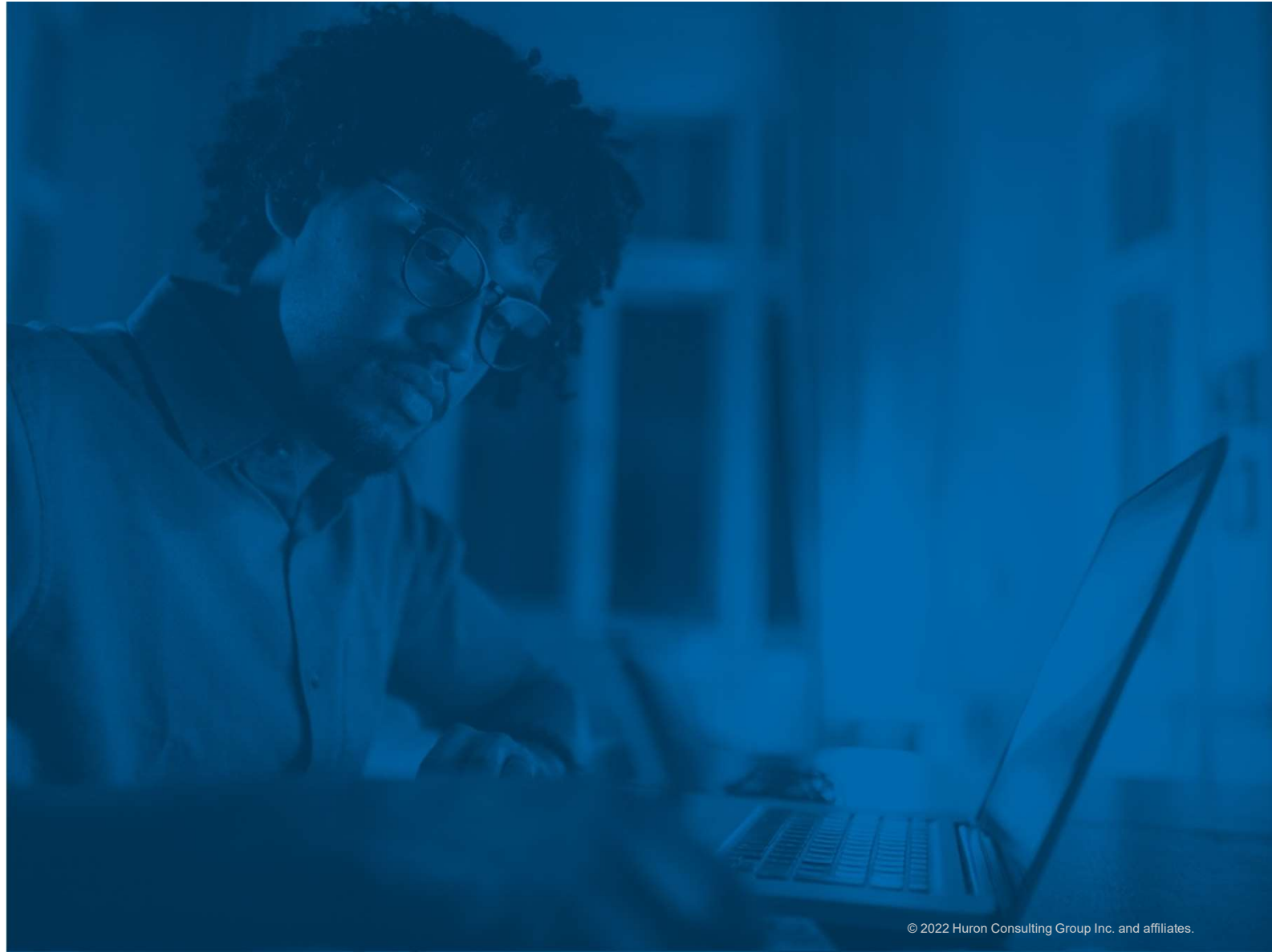

---

## Project Updates





As of December 2021, Huron is winding down data collection and pivoting fully into opportunity development, inclusive of workgroup engagement.

- **HAAS Completion:** HAAS has officially been completed across all institutions, with a systemwide response rate of 76%
- **Workgroup Progress:** Huron has facilitated discussions with 13 distinct workgroups across the system, focusing on opportunities within specific functional areas (ex: benefits administration)
- **Opportunity Development:** With all core data collected, the project team is now fully focused on opportunity development and analysis



# Activities Overview

The first phase involved a set of activities that aimed to provide a clearer understanding of systemwide operations and better contextualized the Study's purpose with institutional leaders.

				
<b>DATA REQUEST</b> Operational and functional data was requested from all institutions to support Study findings	<b>HAAS</b> HAAS was deployed to collect data on how employees spend their time on everyday activities	<b>INTERVIEWS</b> Huron conducted 115 interviews across all 16 institutions and their corresponding functional areas	<b>PROJECT WEBSITE</b> A website was developed to provide an overview of the project and create a space to submit feedback	<b>OFI SURVEY</b> The Opportunities for Improvement survey helped identify which activities have the greatest potential for improvement

# HAAS Overview



The Huron Administrative Activity Study will provide detail for opportunity areas by quantifying the scale, distribution, fragmentation, and consistency of administrative effort.

<b>16 Functional Categories</b>	<b>SCALE</b>	What is the effort and financial investment of activities relative to the level of service?
<b>150 Activities</b>	<b>DISTRIBUTION</b>	How is work distributed across the System?
<b>~\$817.8M Administrative Compensation</b>	<b>FRAGMENTATION</b>	Where can we improve professionalization vs. "wearing many hats" delivery models?
<b>~9,194.4 Administrative FTE</b>	<b>CONSISTENCY</b>	How consistent are roles that perform the same activities?

# Study Response Overview

The Administrative Activity Study gathered data from stakeholders across all 16 institutions to develop a comprehensive view of activity across the entire USHE System.

### Response by Institution

-  16 presidential communications
-  300+ webinar viewings
-  76% completion

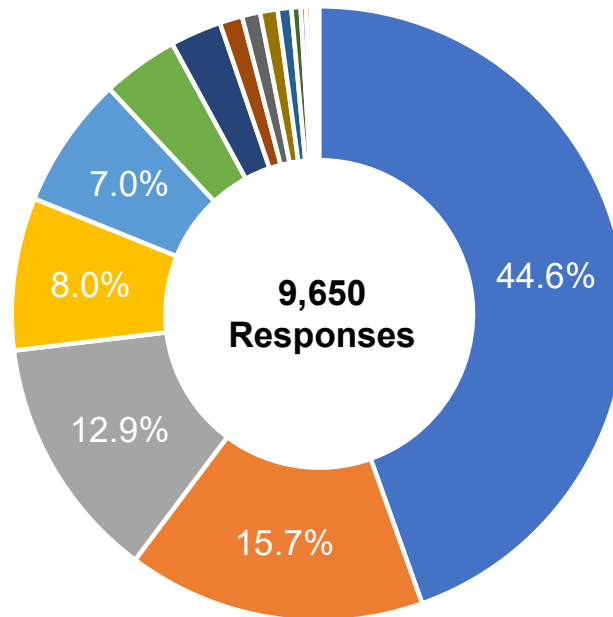

- University of Utah
- Utah State University
- Utah Valley University
- Weber State University
- Salt Lake Community College
- Southern Utah University
- Dixie State University
- Snow College
- Mountainland Technical College
- Davis Technical College
- Bridgerland Technical College
- Ogden-Weber Technical College
- Southwest Technical College
- Tooele Technical College
- Dixie Tech
- Uintah Basin Technical College

# USHE Activity Distribution

The cumulative effort for the Administrative Activity Study respondents represents ~\$817.8M in compensation and 9,194 FTE across 16 functions.

**Total FTE Investment in Administrative Activity: All Institutions**

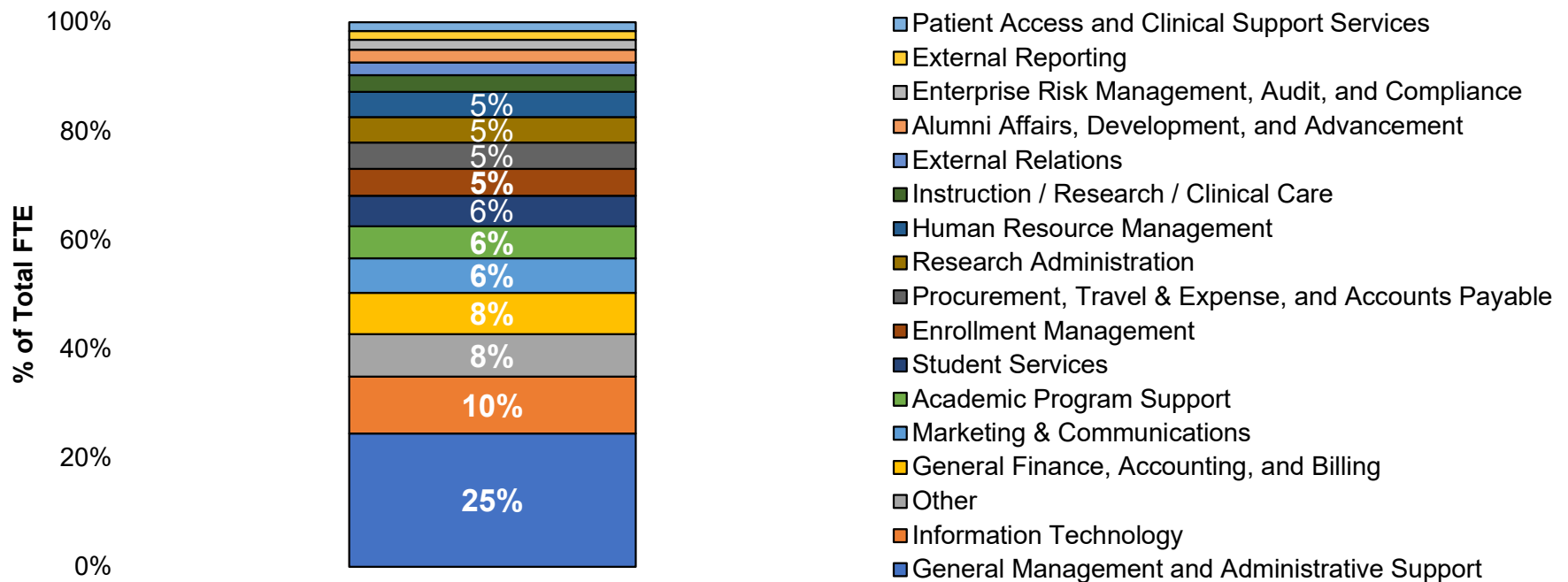

# Institutional Administrative Scale

The level of administrative support varies across institutions, and institutional categories, which highlights opportunities for more granular assessments of administrative efficiency.

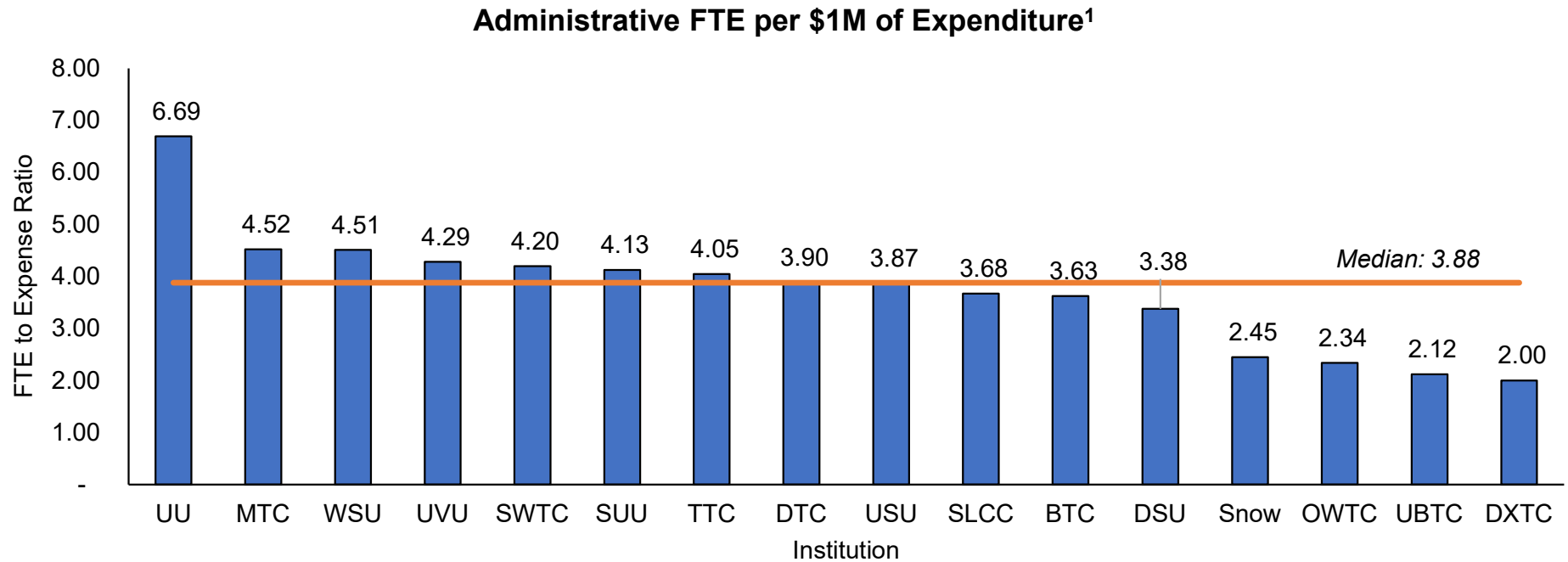

<sup>1</sup>Source: Expenditure is FY2020 annual expenditure per [USHE Institutional Data Resources](#)

## Institutional Operating Profiles

USHE institutions operate with unique operating profiles with varying levels of support developed organically through growth.

Institution Type	General Finance	Human Resources	Information Technology	Procurement
<b>Total Four-Year FTE</b>	<b>630.5</b>	<b>378.6</b>	<b>905.1</b>	<b>402.3</b>
Range of FTE across the 7 Four-Year Institutions	8.5 – 338.1	7.7- 191.2	11.3 – 501.9	5.7 – 190.3
<b>Total Two-Year FTE</b>	<b>71.4</b>	<b>46.4</b>	<b>52.7</b>	<b>41.9</b>
Range of FTE across the 9 Two-Year Institutions	1.0 – 41.1	1.4 – 31.2	1.6 – 22.5	1.0 – 23.4
<b>TOTAL FTE</b>	<b>701.9</b>	<b>425.0</b>	<b>957.8</b>	<b>444.2</b>

# Centralization vs Distributed Activity

USHE institutions often provide centralized services and allow units to create parallel operations for the same services, a business practice that can create inefficiencies and increase risk.

Approximately even allocations of activity and specialists between central and distributed units suggests duplication of operations

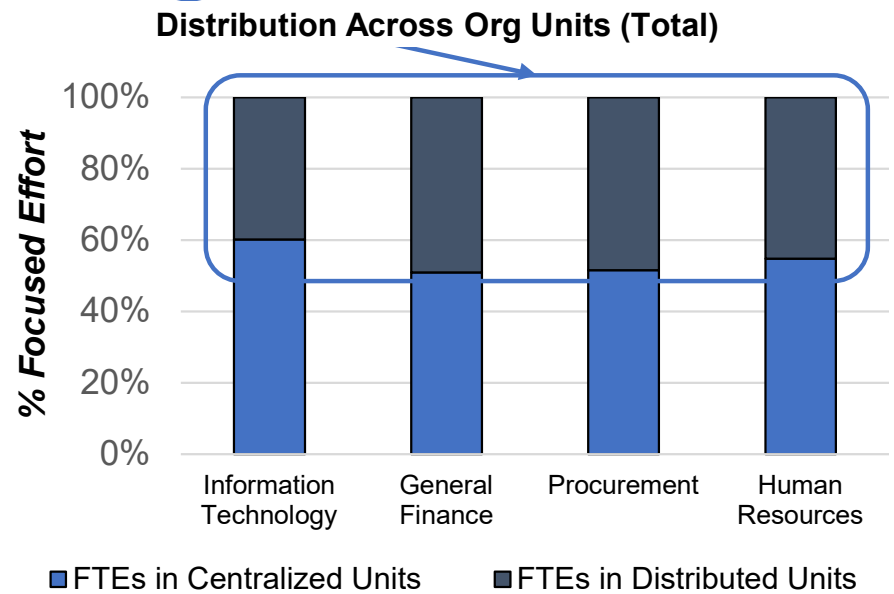
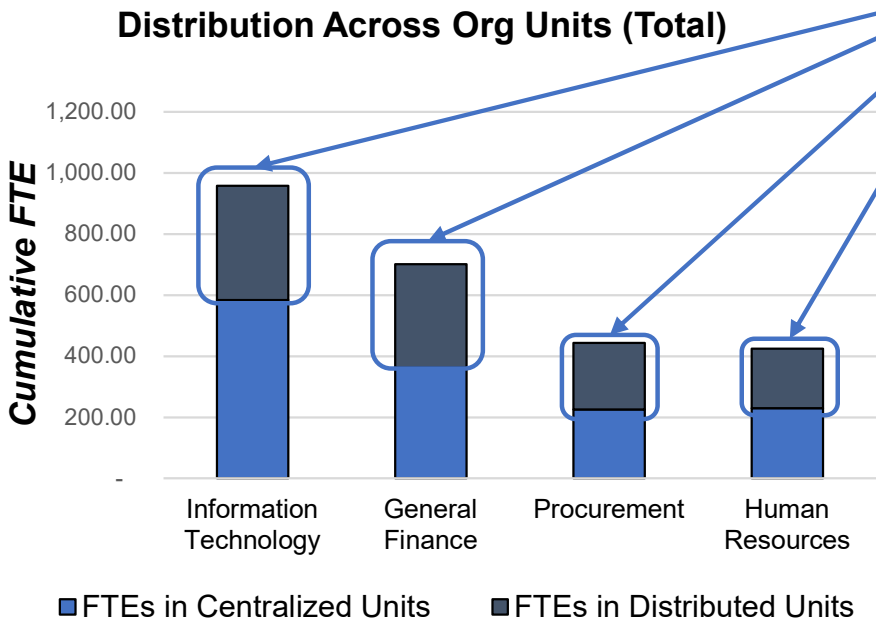

# Fragmentation and Consistency: University of Utah

Administrative assistants at the UU “wear many hats” and have inconsistent job duties, which can create inconsistencies in compensation and equity practices. This finding is mirrored systemwide.

**Role Comparison (by Function):  
Sample of UU Administrative Assistant Job Code**

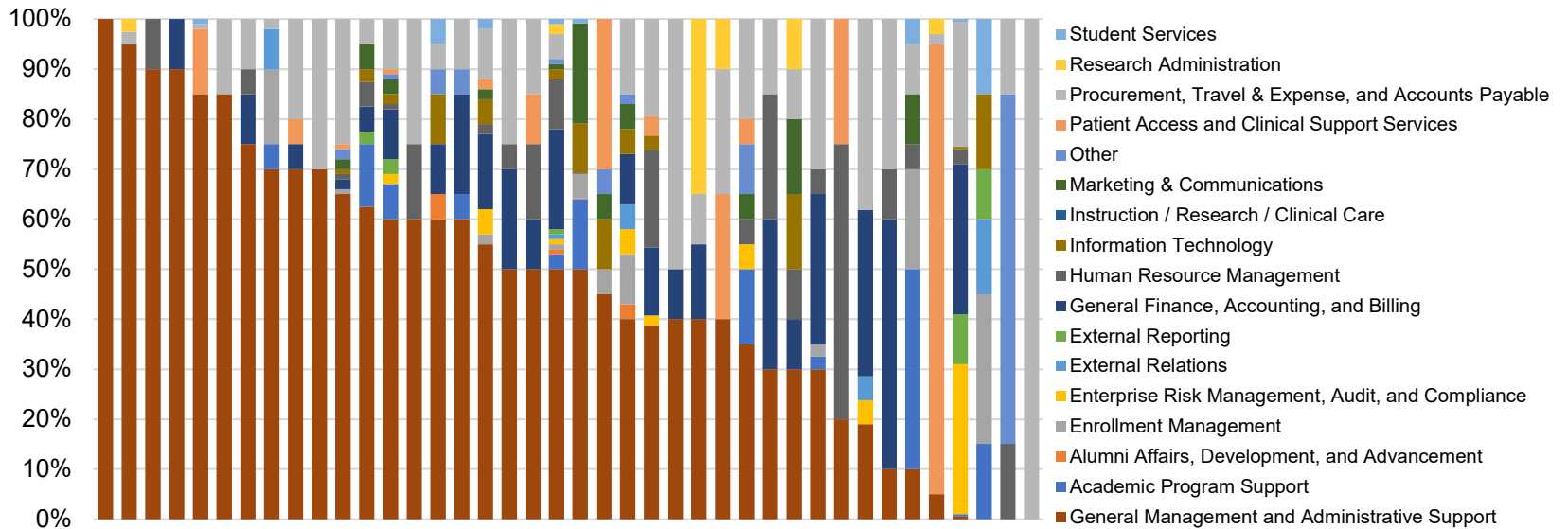

***This analysis includes 40 of 116 Administrative Assistant positions.***

**Interview Quote:**  
*“We are lacking resources and often find ourselves asking our people to become multidisciplinary.”*



# Glossary of Terms

Below is a glossary of terms to utilize as a reference point when reviewing outputs/insights generated via the Huron Administrative Activity Study analysis.

Term	Definition
Functional Area	One of sixteen categories for work performed by employees
Distribution	The extent to which a given functional area is spread across contributing areas
Fragmentation	The extent to which a given employee's effort is allocated across different functional areas
Specialized Employee	An employee that spends 50% or more of their effort in one functional area
Generalist Employee	An employee that does not spend 50% or more of their effort in a functional area
Centralized Unit	Administrative units with reporting lines to their respective functional lead. An example is a finance unit reporting up to a CFO
Distributed Unit	Units that may perform some level of administrative work that do not report to the corresponding functional lead. For example, units in academic affairs are largely considered distributed



 **HURON**



# Phase 3 Report

## USHE Shared Services Study



---

# Agenda

1. Executive Summary
2. Core Enablers of Shared Services
3. Business Cases

# 1

---

## Executive Summary

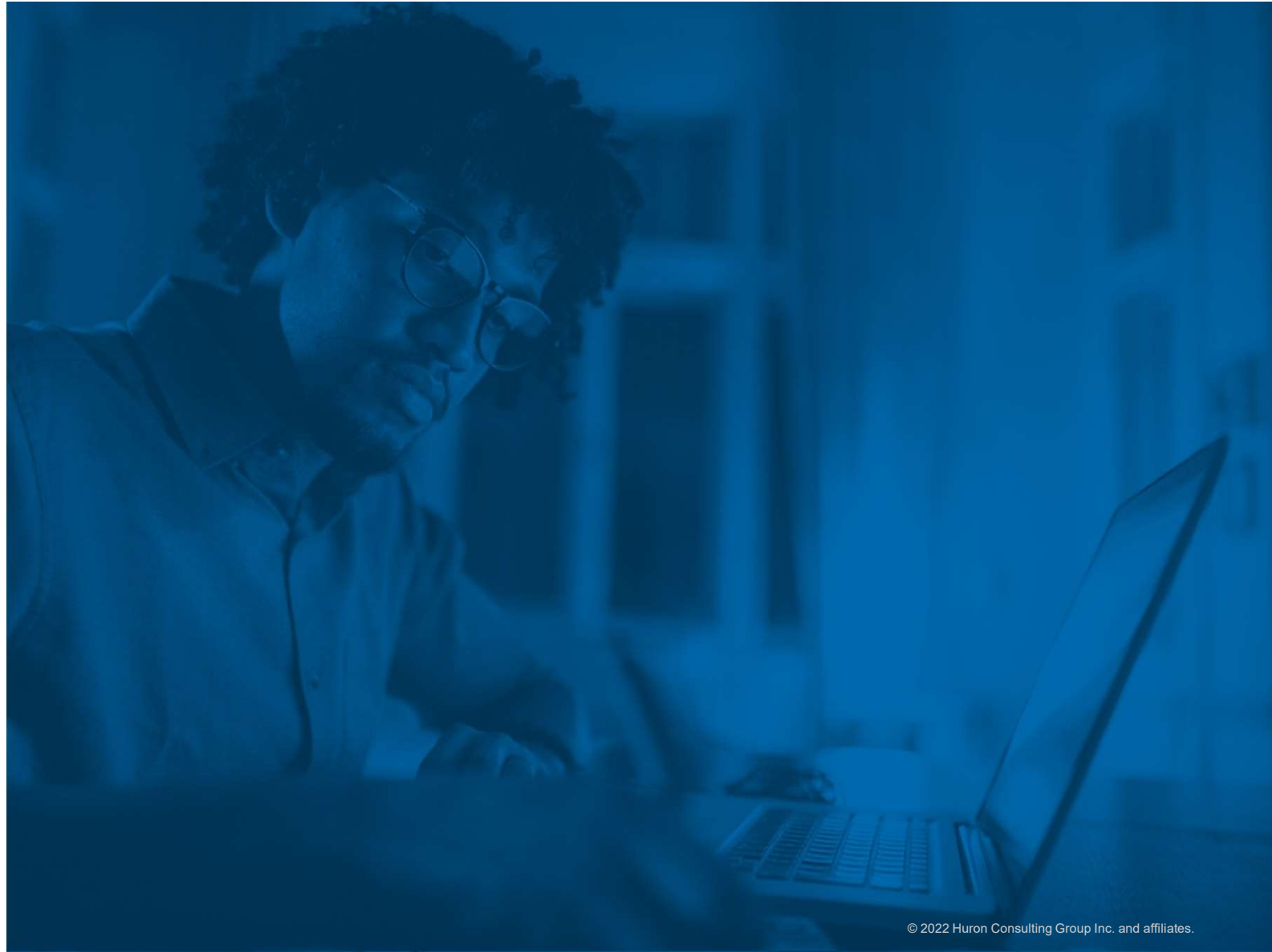

## Phase 3 Overview

Phase 3 analyses have integrated additional data elements, information gathering, and scenario development to provide a foundation for decision-making and further stakeholder discussion.

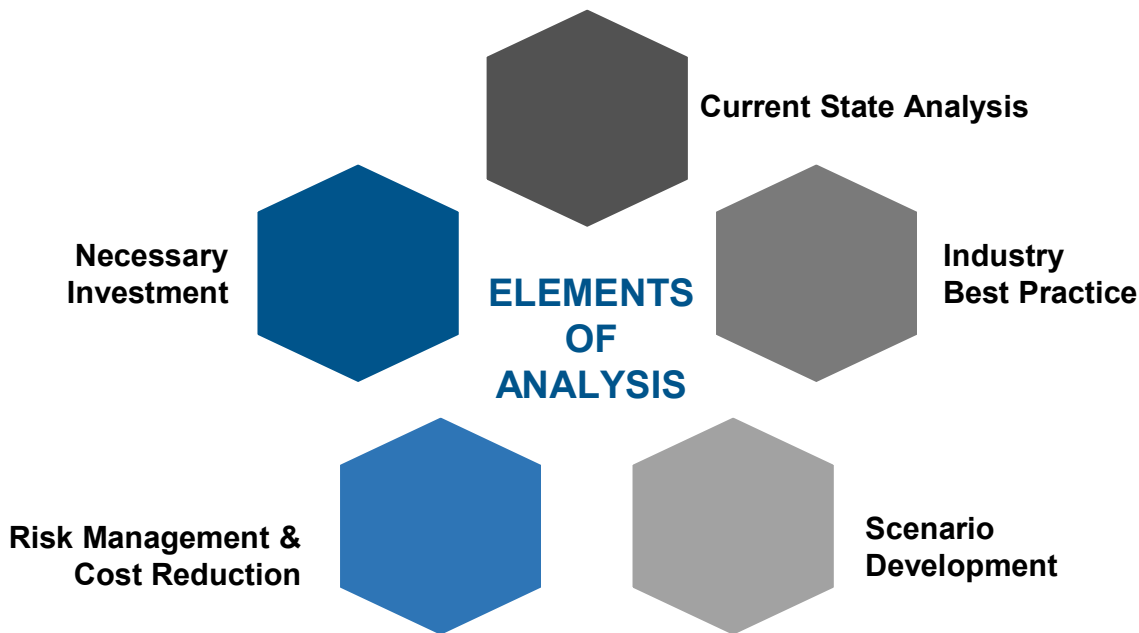

Phase 3 presents a comprehensive assessment of the key elements that USHE should consider as it begins to make decisions around further design and implementation of desired opportunities.

---

## Business Cases

In partnership with USHE leadership, Huron has developed 7 business cases, each detailing a unique, impactful recommendation for the System to consider.

Business Case
1) Security Operations Center
2) Procurement Operating Model
3) Payroll
4) Compensation & Classification
5) Shared Benefits Administration
6) Employment Law
7) Talent Acquisition

# USHE Insights

Through the Study's stakeholder engagement and analysis, Huron has identified a set of insights that help describe USHE's current perspective on change and have informed the Phase 3 opportunities.

## Staff Capacity

### 1. Limited Staff Capacity

- In stakeholder discussions, USHE staff noted that capacity is particularly tight, and resources are strained
- Limited capacity can create obstacles to change efforts, both in terms of having available resources to support 'the work' and maintaining the cultural commitment to implementing the change

## Shared Structures

### 2. Gaps in Collaborative Infrastructure

- While there are select examples of shared, systemwide infrastructure, USHE stakeholders noted that there is still a need for more mature, integrated governance to manage systemwide efforts
- A lack of clear ownership and collaboration can impact transparent accountability for change efforts

## Distinct Cultures

### 3. Strong Institutional Cultures

- USHE stakeholders highlighted that there are strong institutional cultures but not necessarily a consistent systemwide culture that spans multiple institutions
- For multi-institution efforts, it is critical to build a shared culture that can serve as the core vision of the initiative



# 2

---

## Core Enablers of Shared Services

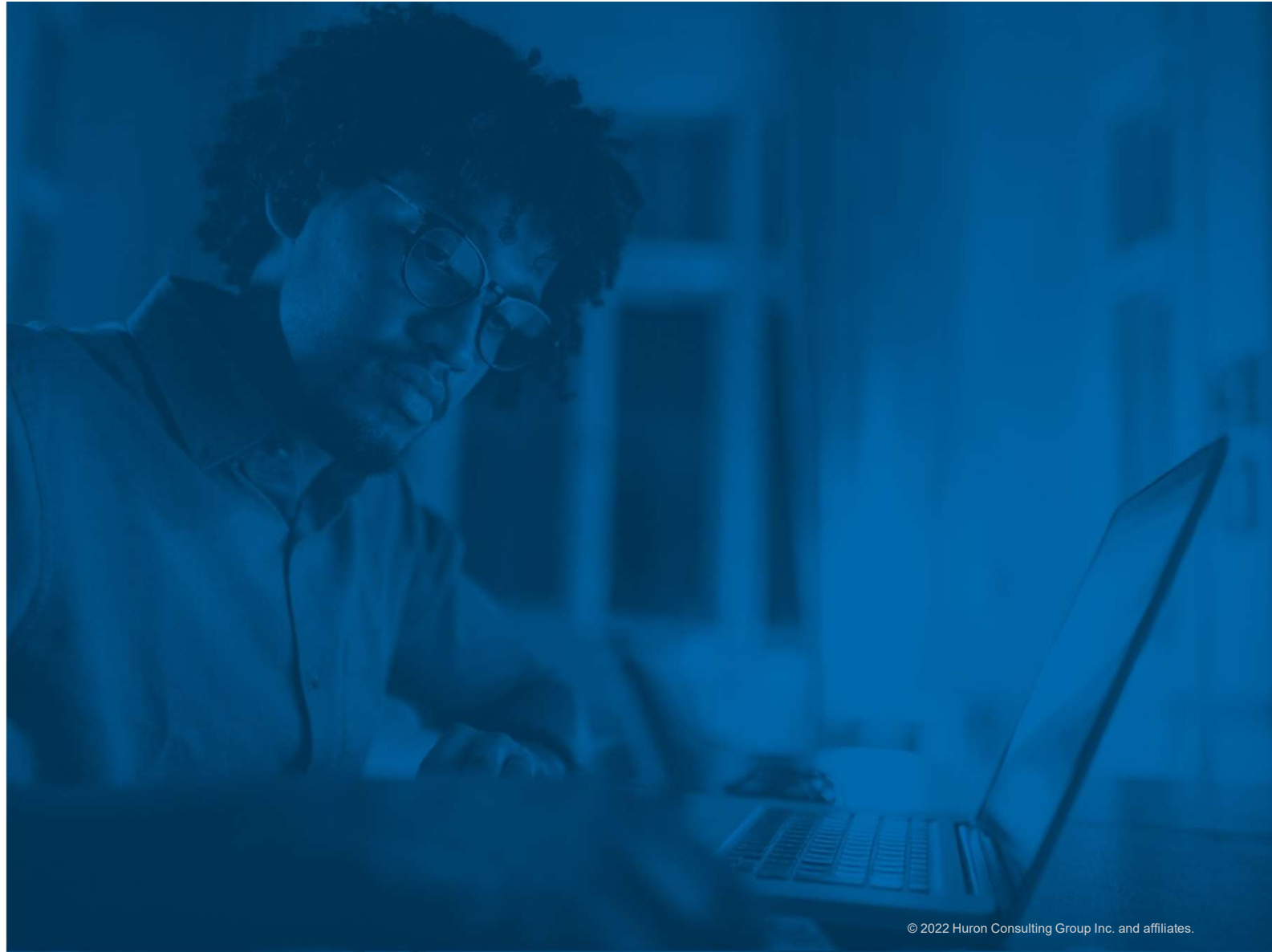

# Overview

In order to successfully implement multi-institutional opportunities, USHE must engage in a set of foundational activities that enable institutions to share resources & services effectively.



## SYSTEM GOVERNANCE

Defining mechanisms for collaboration and establishing an infrastructure to drive & oversee change



## POLICY STANDARDIZATION

Develop a consistent policy infrastructure to allow for a foundation of compliance and procedure



## TECHNOLOGICAL CONSISTENCY

Identify key technologies to adopt systemwide, enabling increased data sharing and support

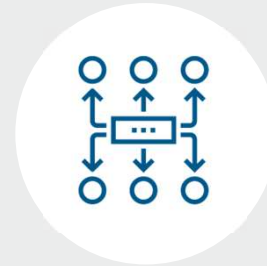

## PROCESS REDESIGN

Standardize processes around shared resources to create efficiency in service

# System Governance

USHE's governance emphasizes institutional independence, making the outcomes of coordinated initiatives highly dependent upon governance and the mechanism for creating collaboration.

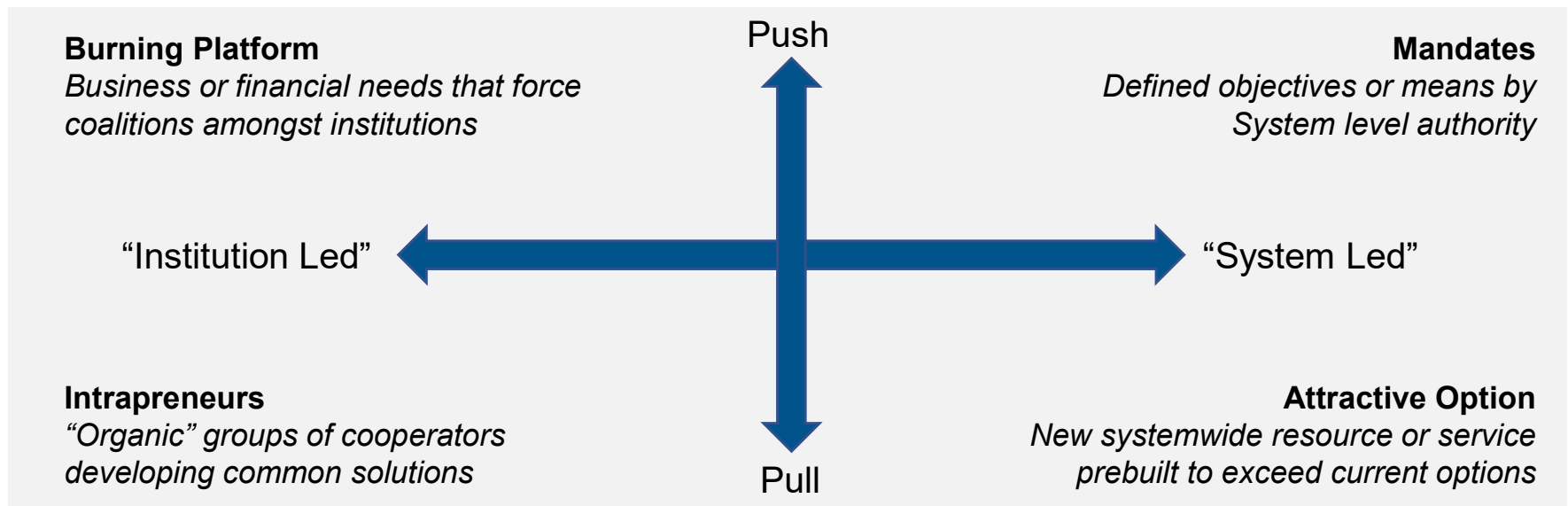

**Collaboration across institutions will require a defined strategy, supported by formalized governance, around how USHE will manage change.**

# Policy Standardization

Productive partnership across USHE institutions is reliant on the standardization of policies in order to eliminate the confusion that comes from institutional gaps and contradictory compliance expectations.

- Current USHE operations depict **varying policies across the System**, which has led to difficulty in systemwide engagements.
- Before standardization can happen at the System level, select institutions will have to first **standardize at the local level**.
- Without clear delineation of policy, systemwide technology and processes will be challenged to progress which will **result in decreased efficiency**.
- Policies that vary across institutions present potential risks for perceptions of unfairness which **harms employee morale**.

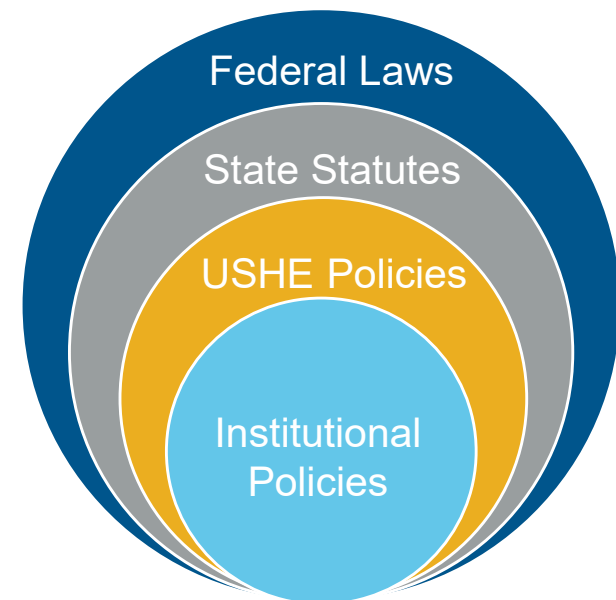

**Multi-institutional opportunities will require alignment and standardization of policies to ensure that shared operations can apply consistent and equitable standards.**

# Technology Consistency

USHE utilizes a wide variety of technological platforms across in-scope functional areas. For select opportunities, shared services will require adoption of a singular platform across USHE institutions.

- Technology dictates process, required resources, and foundational data structure
- Shared services with non-standard platforms necessitates layers of translation/integration, which greatly decreases efficiency
- Singular technology allows for cost savings via increased buying power

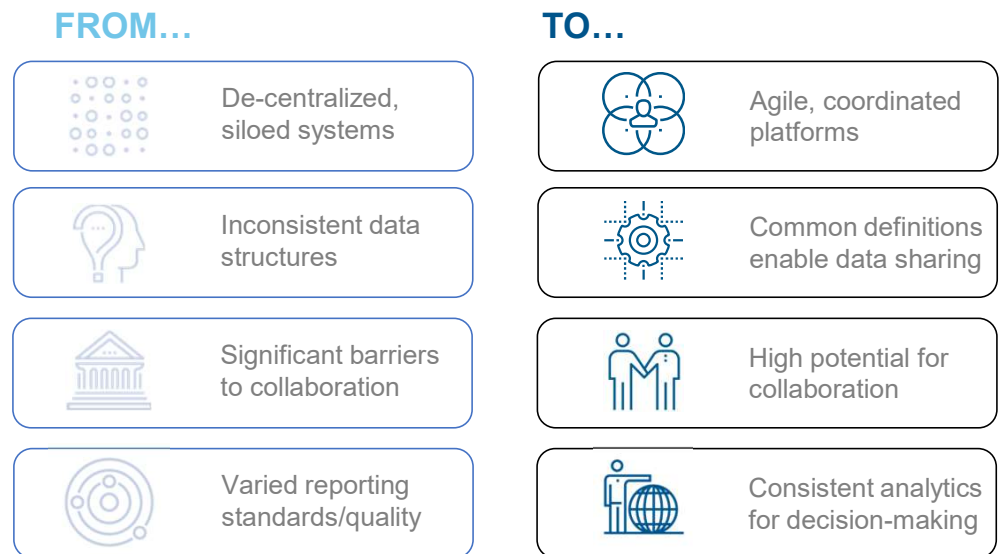

**Significant multi-institutional collaboration across USHE must be grounded in a move towards consistency in technological platforms.**

# Process Redesign & Standardization

Multi-institutional shared services require standardized processes and procedures in order to create consistency of services and enable collaboration across distinct USHE institutions.

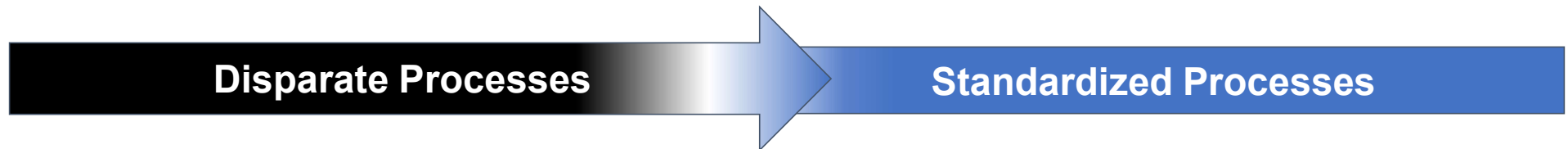

- 1 Process redesign is grounded on detailed mapping of current state processes in order to understand current state workflow and identify areas where units/populations require unique or exception-based processes (e.g., research)
- 2 Engage a set of systemwide subject matter experts to redesign processes around future state structures, leveraging industry best practice and technology to increase efficiency and develop consistency in service
- 3 Design and deploy a process transition plan, including communication and engagement with impacted populations, role-based training curricula, and the development of job aids/support pathways to support adoption

**Process standardization will be a required element for USHE shared services, ensuring that distinct institutions align on workflow for shared resources and structures.**

# Roadmap to Systemwide Shared Services

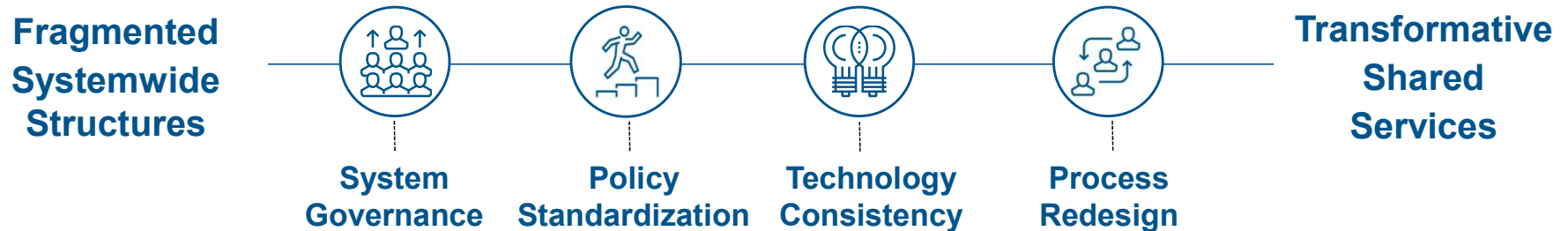

These steps towards transformative shared services are **core enablers** of the opportunities outlined in subsequent slides, playing critical roles in USHE's ability to **successfully implement** the opportunity, the level of **efficiency gained**, and the potential for **cost reduction and risk mitigation**.

# 3

---

## Security Operations Center

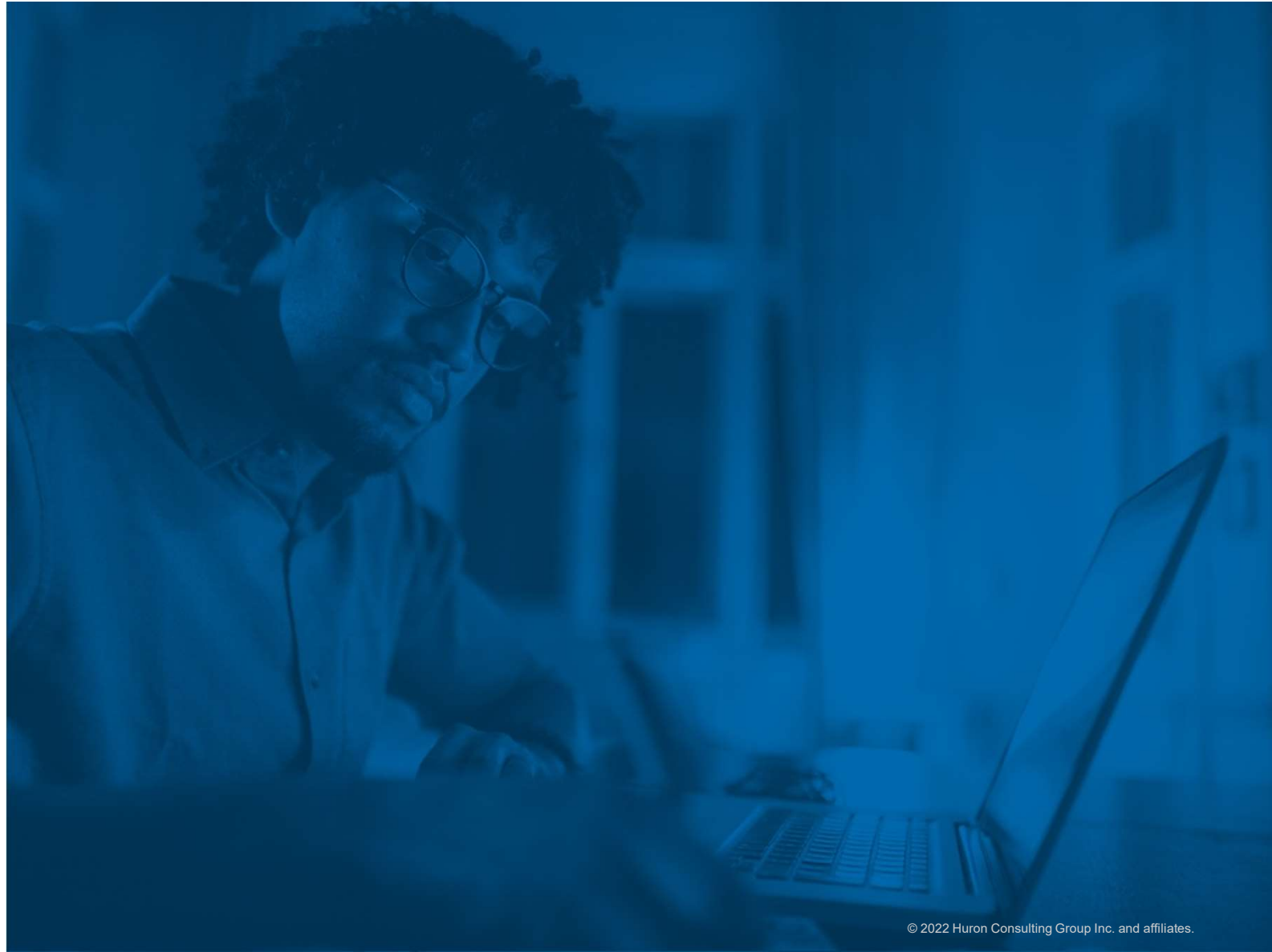



# Overview of Opportunity

During interviews with IT stakeholders across the System, concern around cybersecurity was a strong theme. To address this concern, USHE can develop a systemwide Security Operations Center.

- Cybersecurity threats loom large in the minds of IT leadership across the entire System
- There are regulatory pressures to safeguard personally identifiable information (FERPA/HIPAA)
- Insurance companies are requiring greater security measures be in place in order to grant a policy
- Expertise in IT security is expensive while breaches can be even more expensive
- Vigilance necessitates a consistently high level of performance executing the fundamentals

## U.S. Data Breaches per Year<sup>1</sup>

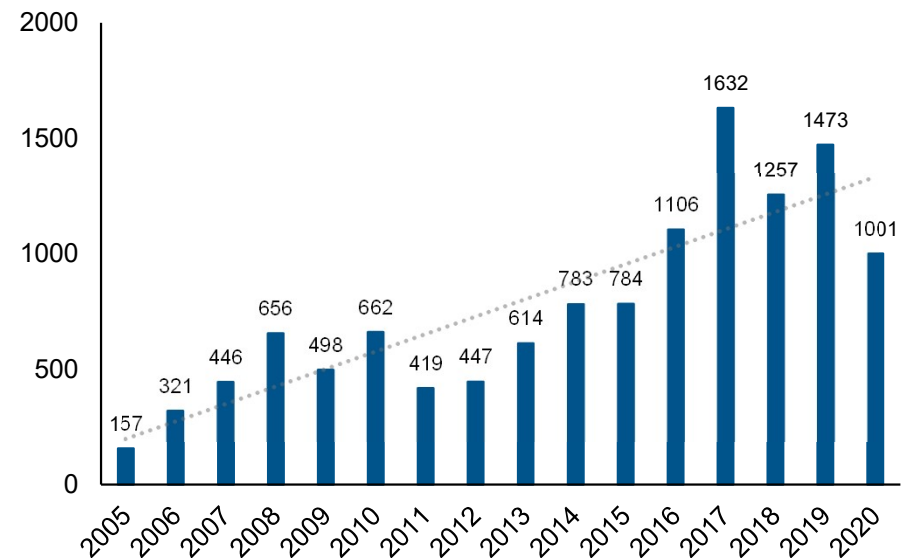

**Despite variances in the overall trend, data breaches in the U.S. are climbing. The threat across the System will be best mitigated with a coordinated effort lead by a Security Operations Center.**

Source: <sup>1</sup> Statista, 2022.

## Risk Factors

Risk is a function of the value of the assets being protected, the level of the threat, and the vulnerability of the institution.<sup>2</sup> Of these three, the one that can be most directly targeted is vulnerability.

- A 2020 study by IBM indicated that the average total cost per breach specifically in the education sector was \$3.9M
- Attackers can fail countless times but only need to succeed once
- Having insurance does not release the insured from maintaining security controls<sup>1</sup> and may not cover breaches that result from social engineering schemes
- The threat environment has been growing and evolving, with no sign of slowing down or reversing

$$\text{Risk} = \text{Assets} \times \text{Threat} \times \text{Vulnerability}$$

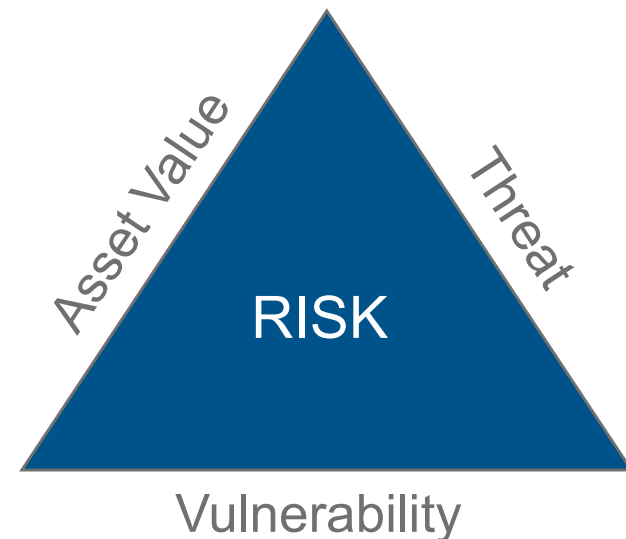

**The most direct way to manage the risk of a data breach is to minimize vulnerabilities.**

Source: <sup>1</sup> <https://www.gbainsurance.com/avoiding-cyber-claim-denials>

<sup>2</sup> EDUCAUSE "Effective Security Metrics: A Guide to Effective Security Metrics"

# Exploring the Components of Risk

In order to quantify the amount of risk that can be mitigated, it is important to examine the stats that have been published with an eye to those specific to Higher Education when available.

## Asset Value

- Adjusting for Higher Ed, the estimated cost of a data breach is \$96 per record<sup>1</sup>
- There are tens of millions of records across USHE institutions<sup>2</sup>

## Threat to Higher Ed<sup>1</sup>

- Between 2005 – 2020 there were 995 breaches in Higher Ed (24.5M records):
  - 48% Malicious Attacks
  - 26% System Glitch
  - 26% Human Error

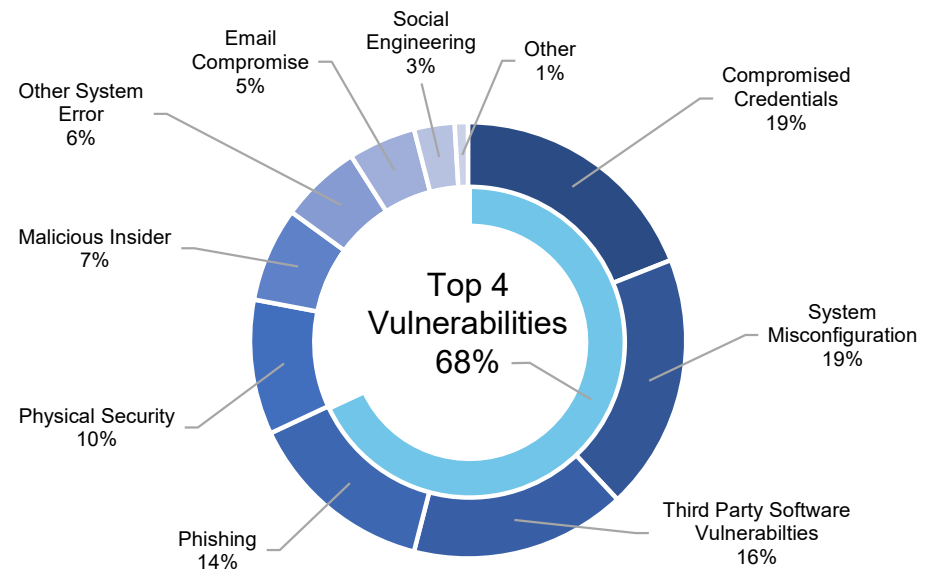

**Addressing the top four vulnerabilities reduces that element of the risk equation by up to 68%.**

Note: The IBM report states a number of \$160 but 40% of that number is attributed to lost revenue. As the higher ed revenue lifecycle is different, we have adjusted this estimate down.

Sources: <sup>1</sup> Cost of a Data Breach, IBM, 2020 <sup>2</sup> At least 35M records just at the 4-year schools, excluding UU.

# Costs of Breaches

The costs associated with breaches can be categorized in four discrete types; detection and escalation, notification, post-breach response activities, and lost revenue.<sup>1</sup>

Detection & Escalation	Notification	Post-Breach Response	Lost Revenue
<ul style="list-style-type: none"><li>▪ Forensic investigations</li><li>▪ Auditing</li><li>▪ Assessment</li><li>▪ Crisis management</li><li>▪ Communications with leadership team</li><li>▪ Development of a communication plan</li></ul>	<ul style="list-style-type: none"><li>▪ Emails, letters, phone calls, and other means of giving notice</li><li>▪ Meeting regulatory requirements</li><li>▪ Communications with regulators</li><li>▪ Engaging outside experts</li></ul>	<ul style="list-style-type: none"><li>▪ Handling queries through a service desk</li><li>▪ Credit monitoring and identity protection services</li><li>▪ Legal expenditures</li><li>▪ Regulatory follow-up</li><li>▪ Remediation of exploited vulnerabilities</li></ul>	<ul style="list-style-type: none"><li>▪ Business disruption</li><li>▪ System downtime</li><li>▪ Reputation loss</li><li>▪ Diminished goodwill</li><li>▪ Potential loss of students who choose to enroll elsewhere due to breach</li></ul>

**The cost of a breach begins at the time of detection and can continue for a prolonged period depending on the impact of legal and regulatory requirements.**

Source: <sup>1</sup> "Cost of a Data Breach Report," IBM, 2021.

## Example of Higher Education Breaches

The largest known breach in higher education occurred at a community college system in Arizona. This incident highlights the threat beyond R1 institutions.



**MARICOPA**  
COMMUNITY COLLEGES

### District Characteristics<sup>1</sup>

- 10 Community Colleges
- 97,162 Enrolled Students (as of Fall 2020)
- Ratio of 32% Full-time/68% Part-time
- 59% Female, 40% Male
- 91% of Students live in Maricopa County

In April 2013, the Maricopa County Community College District experienced a data breach of approximately 2.5M records which included students, graduates, staff, and vendors spanning 30 years.

As of November 2014, the district board had approved over **\$26M in costs** to address the breach to include legal fees, notification and monitoring services, and consulting fees, while only \$867K had been paid out by insurance.<sup>2</sup>

**Cybersecurity breaches are real threats that are actively impacting institutions across the higher education industry and can result in millions of unplanned expenses.**

Sources: <sup>1</sup> <https://www.maricopa.edu/about/institutional-data/dashboards/fast-facts>

<sup>2</sup> <https://www.azcentral.com/story/news/local/phoenix/2014/12/17/costs-repair-massive-mcccd-computer-hack-top-million/20539491/>

# IT Security Staffing Analysis

Using a benchmark for the number of users per IT security staff member within the government and nonprofit sector, only UU has a staffing level that is close to that metric.

IT Security Staffing vs. Benchmark<sup>1</sup>

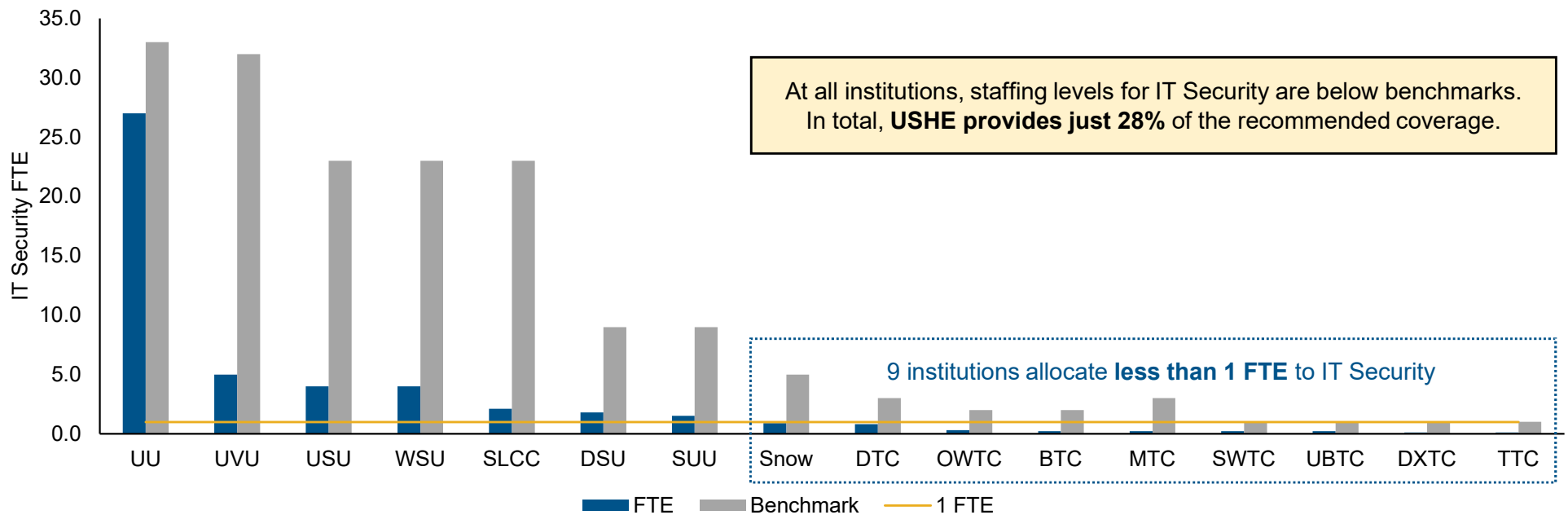

<sup>1</sup>Source: IT Staffing Ratios, Computer Economics, 2019.

# Current Information Security Cost Analysis

USHE's current information spend is heavily centered on four-year institutions, with cost per FTE ratios having a wide variance at the institutional level.

## IT Security Spend Distribution

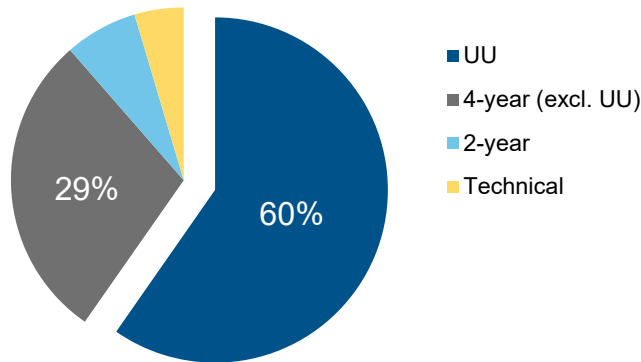

- The majority of the spending on Information Security labor occurs at UU (60%)
- The 4-year institutions together make up 89% of the spend on Information Security

## IT Security Cost per FTE

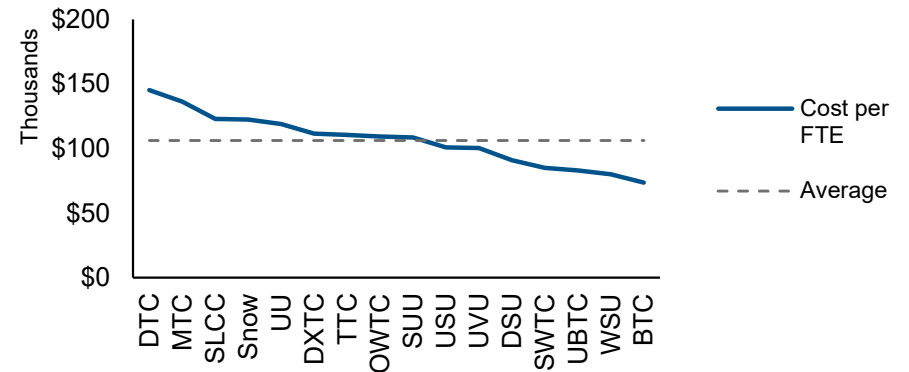

- The range of the per FTE cost for Information Security labor is between \$74K and \$136K<sup>1</sup>
- The average is \$106K per FTE which helps explain why 56% of institutions commit < 1 FTE to security

Source: <sup>1</sup> Huron Administrative Activity Study, 2021.

Note: FTEs were common-sized based on the reported activity from the USHE HAAS study.

# IT Security as Percent of IT Budget

As IT budgets shrink, the percentage of that budget that goes to security appears disproportionate. This disparity across USHE institutions with similar-sized IT orgs suggests inconsistent prioritization.

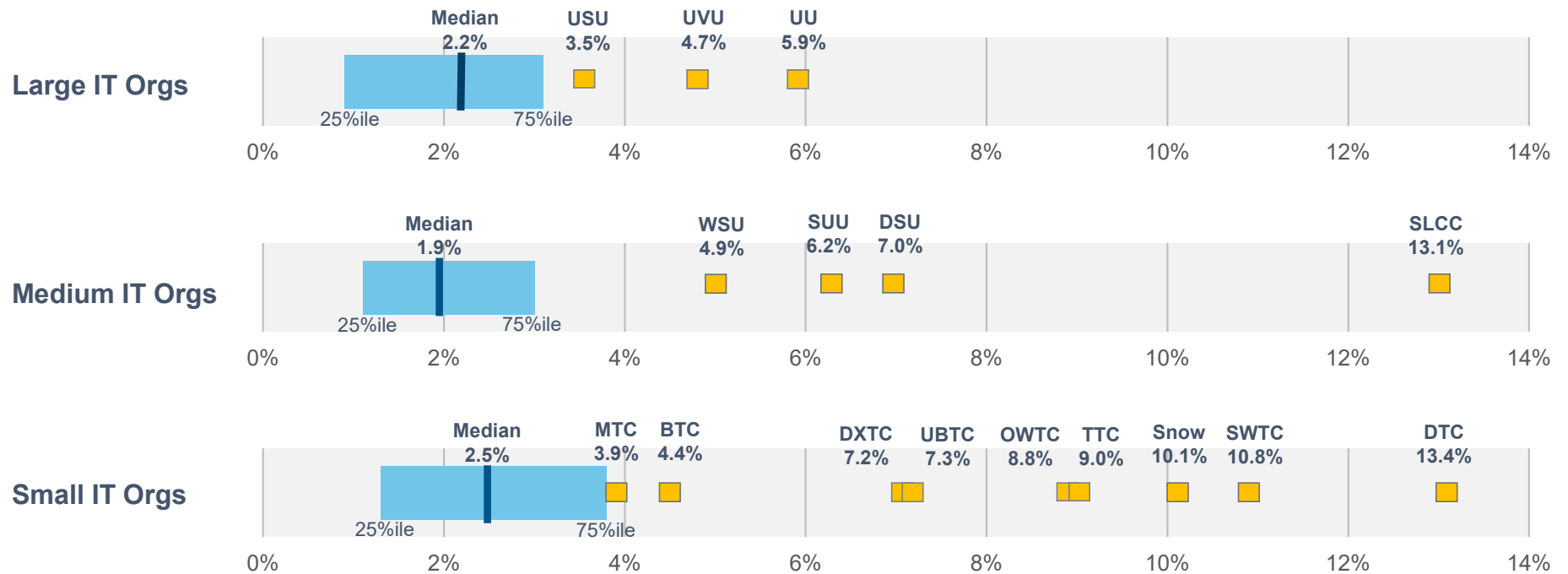

Sources: USHE IT Security labor spending from Huron Administrative Activity Study, 2021.  
Data for IT Org spending by org size from Computer Economics, 2020



# A Layered Model of Security

A SOC serves as the first line of defense which eases the burden on the individual institutions. As the outermost layer, the most value the SOC provides is in stopping adverse events.

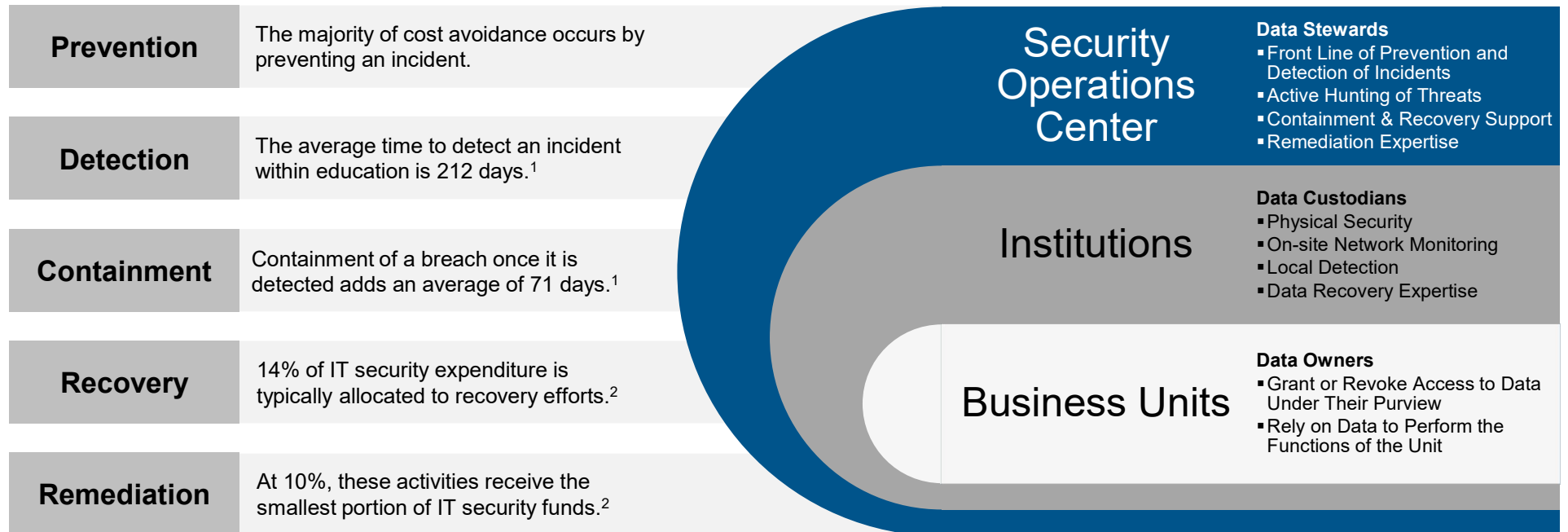

**A Security Operations center provides a first line of defense and provides expertise on all five phases of the cybersecurity lifecycle: prevention, detection, containment, recovery, and remediation.**

Sources: <sup>1</sup> "Cost of a Data Breach Report", IBM Security, 2020.

<sup>2</sup> "The Economic Value of Prevention in the Cybersecurity Lifecycle," Ponemon Institute, 2020.

# Example Security Operations Center

There are precedents for SOC's supporting state-wide university systems. For example, The Texas A&M University System operates a SOC that provides services to 10 institutions.

 <p><b>THE TEXAS A&amp;M UNIVERSITY SYSTEM</b></p> <p><b>SOC Characteristics<sup>1</sup></b></p> <ul style="list-style-type: none"><li>▪ Stops an estimated 1M attacks per month</li><li>▪ Staff:<ul style="list-style-type: none"><li>6 full-time Security Analysts</li><li>2 System Administrators</li><li>1 Business Admin</li><li>10 Student Technicians</li><li>1 Executive Director</li></ul></li></ul>	<p><b>Security Operation Center Services<sup>2</sup></b></p> <ul style="list-style-type: none"><li>▪ Domain Name System Filtering</li><li>▪ Threat Detection and Monitoring</li><li>▪ Software Contracting and Evaluation</li><li>▪ Vulnerability Scanning</li><li>▪ Penetration Tests</li><li>▪ Training &amp; Awareness</li><li>▪ Security Consulting</li></ul>
--	---

**Texas A&M's SOC simplifies processes, standardizes on specific tools, and consolidates resources.**

Sources: <sup>1</sup><https://cybersecurity.tamu.edu/texas-am-university-system-touts-cybersecurity-efforts/>

<sup>2</sup> <https://it.tamus.edu/cybersecurity/soc/>

# Key Factors in Scenario Development

Cost, culture, and benefit are key components in scenario development. However, each factor is inherently complex and the specific approach to an SOC will be driven by USHE decision-making.

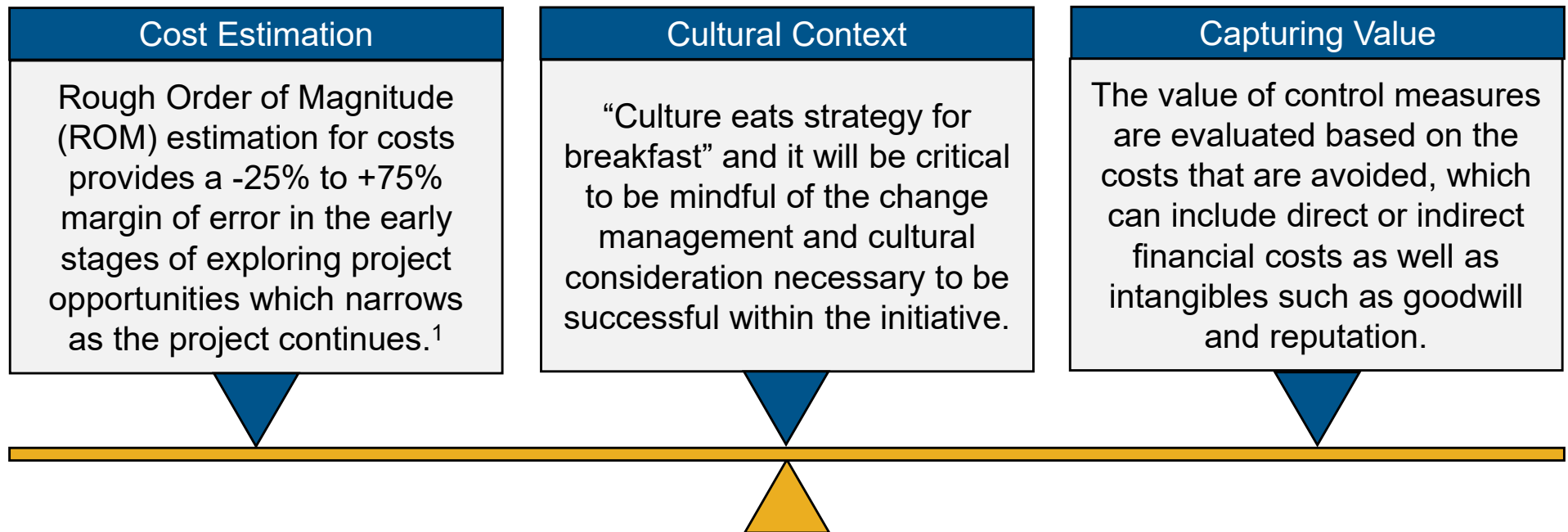

Source: <sup>1</sup> Project Management Institute, PMBOK, 7<sup>th</sup> Edition

# Scenario 1: Extend Current Services

The first proposed scenario involves adding 5 staff in order to extend the current informal services to the technical colleges while maintaining the two-year cycle to visit each campus.

## Summary

- Add 5 FTE decentralized Security Analysts, with home institutions based on need, who will broaden the pool of resources for traveling to campuses for security evaluations
- While this scenario is the closest to the baseline and represents the smallest degree of cultural change, the amount of risk that is mitigated is also the least
- This scenario represents ‘low hanging fruit’

## Benefits

- Building on current successful shared services improves the chances of success
- Can be implemented as a first stage of a larger plan
- Anticipated reduction in vulnerability of between 5% and 15%

## Limitations

- Staff that are added will likely be required to perform other IT functions in addition to security which will minimize their impact
- While impactful, this only represents an incremental improvement to the current state

## Costs

Title	Qty	Salary	40% Fringe	Subtotal
Security Analyst	5	\$530,000	\$212,000	\$742,000
<b>Annual Labor:</b>				<b>\$742,000</b>

**“Security is the #1 thing that keeps me up at night.”**

## Scenario 2: Address Security FTE Levels

This scenario allocates 1 FTE to the 9 institutions that currently have < 1 FTE of IT Security activity, as well as to SLCC which has the largest deficit in IT Security FTE relative to its number of users.

### Summary

- Additional staff broaden the pool who can then add intervention implementation and security consulting services to current on-site testing
- Addresses gaps in IT security personnel as compared to the number of users served at the institution level
- Supports and educates on-site staff as well as providing temporary staffing for security projects for those institutions that choose to opt in

### Benefits

- Increases security staff FTE to all institutions that are currently below 1 FTE for security activities
- Balances institutional cultures and System need
- Anticipated reduction in vulnerability is between 20% and 30%

### Limitations

- Adds more responsibilities to staff who will still need to attend to their home institutions
- Risks sending mixed messages with respect to future IT security plans
- Lacks a true shared infrastructure

### Costs

Title	Qty	Salary	40% Fringe	Subtotal
Security Analyst	10	\$1,060,000	\$424,000	\$1,484,000
Annual Labor:				\$1,484,000

**“We cannot all afford to fund our own security people.”**

# Scenario 3: Build a Security Operations Center

This scenario calls for a transformative change in the approach to security across all USHE institutions in order to meet the persistent threat of the costs associated with breaches.

## Summary

- The SOC is the first line of defense for the entire System and leads the effort to align around common defenses.
- Provides coordinated monitoring, incident response, and threat hunting coupled with user education and policy leadership.
- Hardware and software costs are highly variable, and a definitive estimate will depend on the implementation details.

**“If a SOC is just logging and forwarding those logs, that’s not going to be helpful.”**

## Cost

Title	Qty	Salary	40% Fringe	Labor Subtotal
Security Analyst	4	\$90,000	\$36,000	\$504,000
Sr. Security Analyst	4	\$115,000	\$46,000	\$644,000
System Admin	3	\$80,000	\$32,000	\$336,000
Business Admin	1	\$65,000	\$26,000	\$91,000
Student Technician	12	\$15,000	-	\$180,000
Executive Director	1	\$150,000	\$60,000	\$210,000
<b>Annual Labor:</b>				<b>\$1,965,000</b>
Category				Cost Estimate
Labor				\$1,965,000
Hardware and Software Licenses				\$805,000*
<b>Budgeted Annual Cost:</b>				<b>\$2,770,000</b>

A scan of the industry found claims of \$1.4M in hardware and software costs associated with a SOC over a three-year period. By annualizing and adjusting by +75% to get the upper bound of the ROM estimate range, the cost is about \$805K per year.

## Scenario 3: SOC Benefits and Limitations

The benefits and limitations of building a SOC represent the greatest possible gains through a shared service while recognizing that implementation will be more complex.

### Benefits

- Allows for the most coordinated and aligned effort to be directed at cybersecurity across the System on top of the individual efforts occurring at each institution
- Alignment of security tools will provide equitable protection to institutions that may not have the resources to fund the costs associated with best-in-class cybersecurity tools
- Provide hands-on experience and internship opportunities for students to develop skills
- Anticipated reduction in vulnerability is between 40% and 60%

### Limitations

- This scenario necessitates a high level of operational collaboration and data integration across the System, and will require navigation of culture, policy, and technology
- Lack of standard tools, such as endpoint protection, across the System will limit the efficiency of the SOC, as the personnel will be required to have expertise on all products
- As proposed, the Security Operations Center would not be a 24/7 operation. In order to have around the clock coverage, the minimal staffing required would be 12-14 people in security analyst roles

# Calculating Cost Avoided

Cost avoided can be measured given the anticipated number of incidents per year, the average cost of an incident, the cost of the scenario, and an estimate of the reduction in vulnerability.<sup>1</sup>

- The average total cost of a data breach in the education industry is \$3.90M<sup>2</sup>
- While there is often a high number of overall 'attacks', a very conservative estimate is to assume there to be at least 6 novel, credible 'incidents' per year at operations of USHE's size
- As a System, USHE spends an average of \$106K per annualized FTE on security
- The average cost of a SOC is \$2.68M per year<sup>3</sup>
- Estimates in the reduction in vulnerability for each scenario should be conservative

## ***Reduction in Risk***

= *Anticipated incidents per year*

× *Cost per incident*

× *Reduction in vulnerability with scenario*

## ***Risk Reduction ROI***

= 
$$\frac{(\text{Reduction in Risk} - \text{Cost of scenario})}{\text{Cost of scenario}}$$

## ***Cost Avoided***

= *Cost of scenario* × *Risk Reduction ROI*

**Measuring the cost avoided by implementing differing security control measures is the best way to make a data-driven decision about which options meet the needs of the System.**

Sources: <sup>1</sup> <https://www.cisecurity.org/blog/the-one-equation-you-need-to-calculate-risk-reduction-roi/>

<sup>2</sup> "Cost of a Data Breach Report," IBM, 2020.

<sup>3</sup> "The Economics of Security Operations Centers: What is the True Cost for Effective Results?," Ponemon Institute, 2020.



## Comparing Scenarios

Assuming there are six novel, credible threats per year systemwide and that each one has the potential to cost \$3.9M, the potential cost avoided by the three scenarios presented is detailed below.

#	Scenario	Estimated Cost	Anticipated Reduction in Vulnerability	Reduction in Risk	Risk Reduction ROI	Potential Cost Avoided
1	Add 5 FTE	\$742,000	10%	\$2,340,000	215%	\$1,598,000
2	Add 10 FTE	\$1,484,000	25%	\$5,850,000	294%	\$4,366,000
3	Build a SOC	\$2,770,000	50%	\$11,700,000	322%	\$8,930,000
4	Scenarios 2+3	\$4,249,000	75%	\$17,550,000	313%	\$13,296,000

**Adding FTEs without gaining the benefit of the shared operational efforts will limit the potential for avoiding costs and reduce the potential for risk mitigation.**

Notes: Estimates provided are rough order of magnitude and can be -25% to +75%

# Next Steps and Risk Management

While next steps are highly dependent on specific approach, Huron has outlined the core activities and timelines that will be required to fully develop a USHE Security Operations Center.

Phase	PLANNING	DESIGN	IMPLEMENTATION
Timeline	Month 0 to 3	Month 4 to 12	Month 13 to 24
Key Activities	<p>Decide on the characteristics of the SOC, levels of service, and obtain buy-in from key stakeholders</p> <p>Conduct RFIs to help fill gaps in planning</p> <p>Plan the budgetary aspects and secure commitments for funding</p>	<p>Prepare the site for any on-premises offices</p> <p>Begin hiring SOC personnel</p> <p>Begin RFP processes and vendor selection for SOC-specific hardware, software, and services</p>	<p>Communicate regularly with stakeholders across all institutions</p> <p>Monitor progress and measure performance</p> <p>Begin ongoing cycle of feedback and improvement</p>
Key Risks	<p><b>Cultural Shift:</b> The SOC will be operating in an ecosystem of highly diverse institutions with respect to how priorities are operationalized. Success will require varying degrees of cultural shifts to prioritize security systemwide.</p> <p><b>Capturing Success:</b> Since success will be measured by the absence of adverse events, justifying the ongoing expense will require diligence.</p> <p><b>Adequate Resourcing:</b> Clearly defined roles and responsibilities, with sufficient resource allocation will be key to a successful implementation.<sup>1</sup></p>		

Note: Burnout and high turnover rates were reported as key risks for under-resourced SOC. See "Second Annual Study of Security Operations Centers: What is the True Cost for Effective Results?" Ponemon Institute, 2020.

# 4

---

## Procurement Operating Models

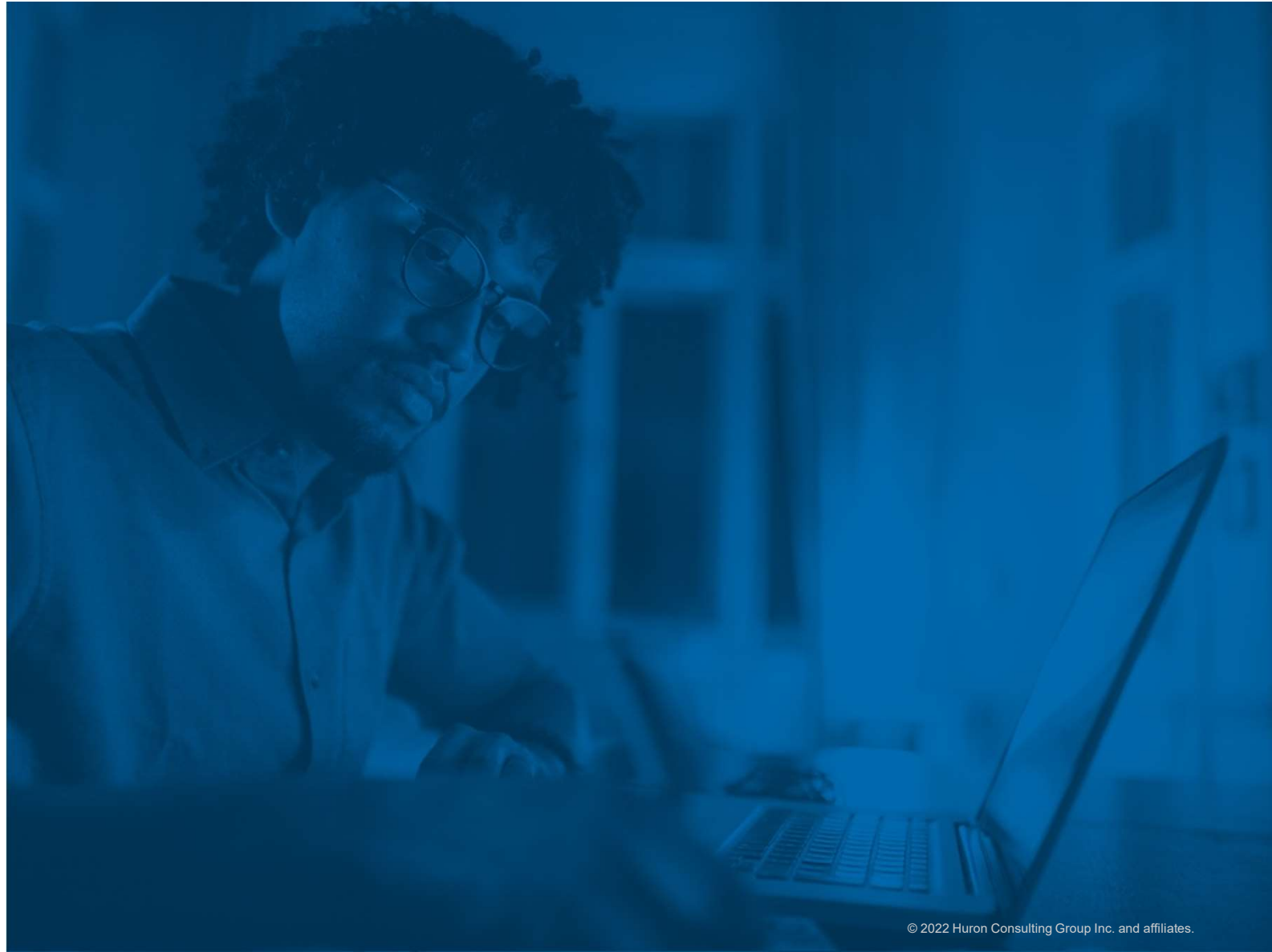

# Overview of Opportunity

Procurement's value-proposition can be enhanced by focusing on increased collaboration, improved data visibility, leveraging System-wide spend, and reducing redundant workload between institutions.

## Executive Summary

- **Rationale:** A revised operating model would lead to an improvement in managed spend across institutions. This would increase procurement collaboration, leading to cost savings, improved service for end users, enhanced data visibility and quality, and reduction of redundant work.
- **Peer Practice:** The University of Colorado System implemented a center-led procurement operating model that has one CPO and service center for all the schools in the System, which is responsible for setting strategies, providing tools and contracts, managing transactions, enforcing policy, etc.
- **Prerequisites:** Currently, institutions have varying procurement systems. Moving to a common procurement system would need to occur before implementing a new operating model, depending on which model is selected.

## Operating Model Options



### EVENT FOCUS

USHE system office helps identify collaboration opportunities and planning for consolidated sourcing events.

Institutions have the structure to collaborate on sourcing events as needed.



### CATEGORY LEADERSHIP

USHE office provides category management services for institutions in high spend areas. Institutions manage all other categories.

Flexible approach with centrally managed strategy and autonomy for institutions to manage the non-center led spend categories and all transactional activities.





































































### CONSOLIDATED

Centralized function aggregates all procurement activities into a single USHE managed service center.

USHE service center is responsible for managing all purchasing and contracting activities.

# Procurement Operating Model Scenarios

	Description	Resource Efficiency	Process Efficiency	Tech Efficiency	Service Increase	Spend Savings	Change Mgmt.	Implementation Cost	Tech Cost	FTE Cost	Overall Impact
 SCENARIO 1	USHE-wide sourcing/contracting collaboration on select categories, with potential for some shared enabling technologies. Institutions manage all other procurement categories and activities.										
 SCENARIO 2	USHE office responsible for category strategies, managing contracts and sourcing for select high spend categories. Institutions manage all other categories and all transactions.										
 SCENARIO 3	Leverage existing university procurement teams by designating different institutions to manage various categories across USHE. Institutions manage all other categories and all transactions.										
 SCENARIO 4	USHE service center has full ownership and direct oversight of all contracting and purchasing activities, providing technologies, enforcing policy, etc.										
 SCENARIO 5	USHE office has full ownership and direct oversight of all contracting and purchasing activities, except University of Utah and Utah State; UofU and USU would still collaborate with the System office.										
 SCENARIO 6	Group procurement operations into a few service centers based on commonality among institutions (large university vs smaller technical colleges) or based on region.										

Note: Red Harvey Ball represents reduced cost

# Scenario 1: Event Focus Collaboration



## SCENARIO 1

### Overview

#### Bottom Line:

Choose this model if you want collaboration for individual sourcing events and low impact to existing procurement practices.

#### Description:

USHE to establish procurement support, facilitating collaboration on select sourcing events identified by the support team on behalf of the participating institutions.

As this is a sourcing event-based model only, all other procurement activities including requisitions and purchase order transactions would remain at the institutions. Additionally, the institutions would continue to manage all other procurement categories.

#### Higher Education Example:

The IUC Purchasing Group of Ohio (IUC-PG) is a purchasing consortium that supports the state institutions of higher education. The IUC-PG coordinates shared sourcing events and creates purchasing agreements for use by its 87 members (the 14 state universities, 15 community colleges, 8 technical colleges and 51 independent educational institutions).

### USHE Illustrative Model

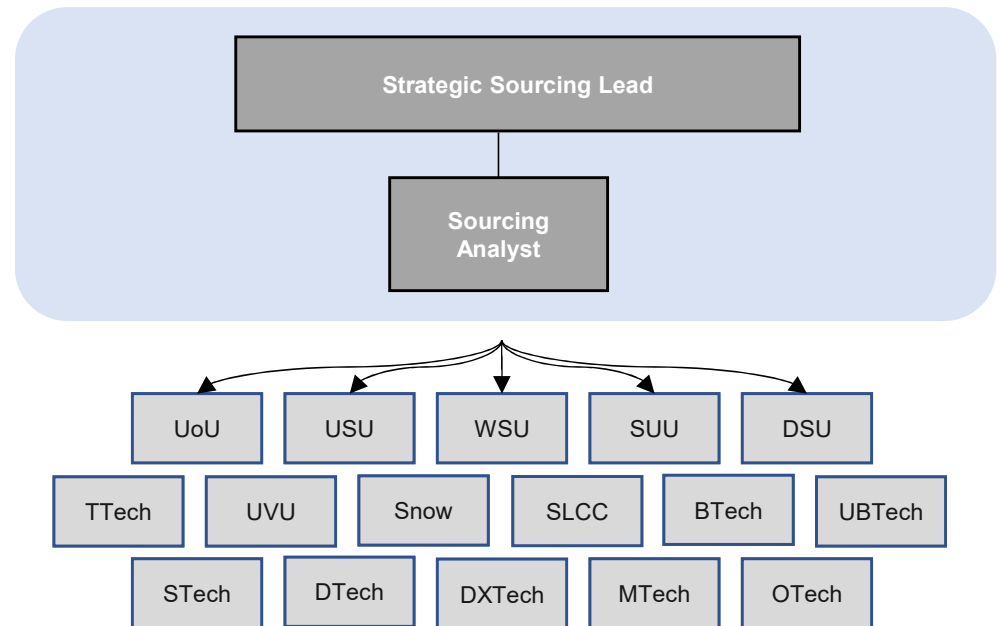

# Scenario 1: Event Focus Collaboration



		Operating Model Considerations																																																																						
		Considerations	Impact	Comments																																																																				
Resource	FTE efficiency opportunity		🕒	<ul style="list-style-type: none"> <li>Institutions will have centralized support on select sourcing events.</li> </ul>																																																																				
	Process	Standardized procurement processes		🕒	<ul style="list-style-type: none"> <li>Standardized sourcing and contracts approach for all select sourcing events, reducing duplicated efforts across institutions and more fully leveraging spend on these categories.</li> </ul>																																																																			
Technology	Standardized procurement tools		🕒	<ul style="list-style-type: none"> <li>No standardized tools (could share sourcing/contract management tools)</li> </ul>																																																																				
	Spend reporting		🕒	<ul style="list-style-type: none"> <li>No additional reporting capabilities</li> </ul>																																																																				
Service	Improved service to campus		🕒	<ul style="list-style-type: none"> <li>Approval and purchasing process enhanced using negotiated agreements.</li> </ul>																																																																				
	Needs of each campus tailored		🕒	<ul style="list-style-type: none"> <li>Institutions would provide input on requirements for select sourcing events.</li> </ul>																																																																				
Spend Savings	Sourcing savings opportunities		🕒	<ul style="list-style-type: none"> <li>Only for select sourcing events, estimated \$1M - \$2M in savings.</li> </ul>																																																																				
	Collaboration		🕒	<ul style="list-style-type: none"> <li>Participation from institutions on select sourcing events.</li> </ul>																																																																				
Change Management	Communicate and implement change		🕒	<ul style="list-style-type: none"> <li>Low effort as this is a minor shift from current practices.</li> </ul>																																																																				
Implementation Cost and Timeline	JAGGAER license cost		🕒	<ul style="list-style-type: none"> <li>Not applicable</li> </ul>																																																																				
	Implementation cost		🕒	<ul style="list-style-type: none"> <li>Not applicable</li> </ul>																																																																				
	FTE cost impact		🕒	<ul style="list-style-type: none"> <li>Two additional FTE resources are estimated including a Strategic Sourcing Lead and a Data Analyst to facilitate USHE-wide sourcing events.</li> </ul>																																																																				
	Implementation timeline		🕒	<table border="1"> <thead> <tr> <th rowspan="2">KEY ACTIVITIES</th> <th colspan="2">FY22</th> <th colspan="4">FY23</th> <th>FY24</th> </tr> <tr> <th>Q3</th> <th>Q4</th> <th>Q1</th> <th>Q2</th> <th>Q3</th> <th>Q4</th> <th>Q1</th> </tr> </thead> <tbody> <tr> <td>Finalize model</td> <td colspan="2">█</td> <td></td> <td></td> <td></td> <td></td> <td></td> </tr> <tr> <td>Identify resources</td> <td></td> <td>█</td> <td></td> <td></td> <td></td> <td></td> <td></td> </tr> <tr> <td>Develop operating procedures</td> <td></td> <td></td> <td colspan="2">█</td> <td></td> <td></td> <td></td> </tr> <tr> <td>Implement enabling technology (N/A)</td> <td colspan="7">█</td> </tr> <tr> <td>Training</td> <td></td> <td></td> <td colspan="2">█</td> <td></td> <td></td> <td></td> </tr> <tr> <td>Deployment</td> <td></td> <td></td> <td></td> <td colspan="2">█</td> <td></td> <td></td> </tr> </tbody> </table>							KEY ACTIVITIES	FY22		FY23				FY24	Q3	Q4	Q1	Q2	Q3	Q4	Q1	Finalize model	█							Identify resources		█						Develop operating procedures			█					Implement enabling technology (N/A)	█							Training			█					Deployment				█		
KEY ACTIVITIES	FY22		FY23				FY24																																																																	
	Q3	Q4	Q1	Q2	Q3	Q4	Q1																																																																	
Finalize model	█																																																																							
Identify resources		█																																																																						
Develop operating procedures			█																																																																					
Implement enabling technology (N/A)	█																																																																							
Training			█																																																																					
Deployment				█																																																																				

# Scenario 2: Centralized Support for Key Categories



## SCENARIO 2

### Overview

#### Bottom Line:

Choose this model if you want collaboration and more proactive category strategies and expertise on designated spend categories, driving increased savings opportunities across the institutions.

#### Description:

USHE to establish a procurement center of excellence for the system. The procurement COE would work across the system to establish systemwide category strategies and agreements for goods and services that are commonly purchased across the System institutions.

The establishment of category strategies and contracts are in scope for select categories, but all other categories and procurement activities and transactions would remain at the institutions.

#### Higher Education Example:

The University of California (UC) System Procurement uses strategic and collaborative sourcing methods to optimize spend on key categories across the UC system, creating significant savings for the University. UC Procurement partners with campus procurement teams to leverage spend across the selected categories.

### USHE Illustrative Model

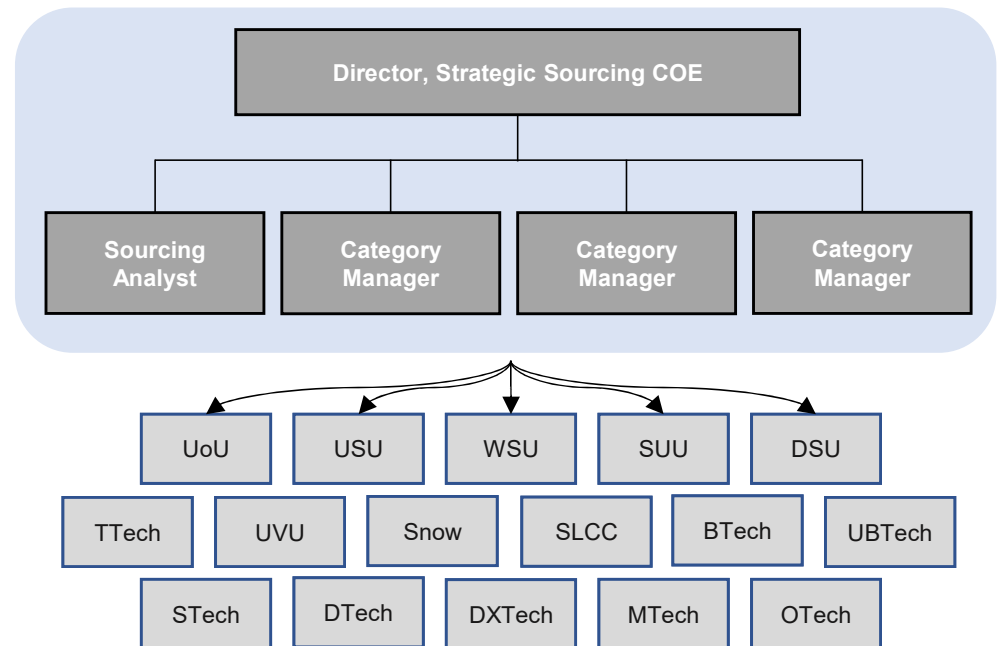



# Scenario 2: Centralized Support for Key Categories



		Operating Model Considerations																																																																			
		Considerations	Impact	Comments																																																																	
Resource	FTE efficiency opportunity		🕒	<ul style="list-style-type: none"> <li>Additional resources responsible for centralized spend categories. Existing university resources would remain the same, but leverage system category expertise.</li> </ul>																																																																	
	Process	Standardized procurement processes		🕒	<ul style="list-style-type: none"> <li>Standardized sourcing and contracts approach for select spend categories. Reduced duplication of efforts.</li> </ul>																																																																
Technology	Standardized procurement tools		🕒	<ul style="list-style-type: none"> <li>Common system using JAGGAER for Sourcing and Contracts for all institutions, increased automation and collaboration.</li> </ul>																																																																	
	Spend reporting		🕒	<ul style="list-style-type: none"> <li>Increased spend visibility for institutions across select categories.</li> </ul>																																																																	
Service	Improved service to campus		🕒	<ul style="list-style-type: none"> <li>Approval and purchasing process enhanced using negotiated agreements.</li> </ul>																																																																	
	Needs of each campus tailored		🕒	<ul style="list-style-type: none"> <li>Institutions provide input on needs for centralized categories and maintain independence on all other categories.</li> </ul>																																																																	
Spend Savings	Sourcing savings opportunities		🕒	<ul style="list-style-type: none"> <li>Enhanced purchasing power and proactive category strategies within select categories, estimated \$3M - \$7M in sourcing savings.</li> </ul>																																																																	
	Collaboration		🕒	<ul style="list-style-type: none"> <li>Drives participation on select spend categories among all institutions.</li> </ul>																																																																	
Change Management	Communicate and implement change		🕒	<ul style="list-style-type: none"> <li>Moderate effort as this is a shift from current practices at the spend category level.</li> </ul>																																																																	
Implementation Cost and Timeline	JAGGAER license cost		🕒	<ul style="list-style-type: none"> <li>\$175K - \$225K estimated annual system costs for Sourcing and Contracts based on a 5-year term. Existing customers to extend their contracts accordingly.</li> </ul>																																																																	
	Implementation cost		🕒	<ul style="list-style-type: none"> <li>Cost range to be determined, includes technology and model implementation efforts.</li> </ul>																																																																	
	FTE cost impact		🕒	<ul style="list-style-type: none"> <li>The COE is estimated to include five (5) resources, three (3) of which would be responsible for category strategy and RFP execution.</li> </ul>																																																																	
	Implementation timeline		🕒	<table border="1"> <thead> <tr> <th rowspan="2">KEY ACTIVITIES</th> <th colspan="2">FY22</th> <th colspan="4">FY23</th> <th>FY24</th> </tr> <tr> <th>Q3</th> <th>Q4</th> <th>Q1</th> <th>Q2</th> <th>Q3</th> <th>Q4</th> <th>Q1</th> </tr> </thead> <tbody> <tr> <td>Finalize model</td> <td colspan="2">█</td> <td></td> <td></td> <td></td> <td></td> <td></td> </tr> <tr> <td>Identify resources</td> <td></td> <td colspan="2">█</td> <td></td> <td></td> <td></td> <td></td> </tr> <tr> <td>Develop operating procedures</td> <td></td> <td></td> <td colspan="2">█</td> <td></td> <td></td> <td></td> </tr> <tr> <td>Implement enabling technology</td> <td></td> <td></td> <td colspan="3">█</td> <td></td> <td></td> </tr> <tr> <td>Training</td> <td></td> <td></td> <td></td> <td colspan="2">█</td> <td></td> <td></td> </tr> <tr> <td>Deployment</td> <td></td> <td></td> <td></td> <td></td> <td colspan="3">█</td> </tr> </tbody> </table>				KEY ACTIVITIES	FY22		FY23				FY24	Q3	Q4	Q1	Q2	Q3	Q4	Q1	Finalize model	█							Identify resources		█						Develop operating procedures			█					Implement enabling technology			█					Training				█				Deployment					█	
KEY ACTIVITIES	FY22		FY23				FY24																																																														
	Q3	Q4	Q1	Q2	Q3	Q4	Q1																																																														
Finalize model	█																																																																				
Identify resources		█																																																																			
Develop operating procedures			█																																																																		
Implement enabling technology			█																																																																		
Training				█																																																																	
Deployment					█																																																																

# Scenario 3: Institution Support for Key Categories



## SCENARIO 3

### Overview

#### Bottom Line:

Choose this model if you want collaboration and more proactive category strategies and expertise on designated spend categories, but do not want to put in place a separate centralized infrastructure.

#### Description:

Similar to Scenario 2, this model focuses on leveraging system-wide spend within select categories. However, different institutions within USHE would be tasked with managing these category strategies and sourcing/contracting initiatives on behalf of the System from a sourcing and contracting perspective.

The establishment of category strategies and contracts are in scope for select categories, but all other categories and procurement activities and transactions would remain at the institutions.

#### Higher Education Example:

This is an alternative option which is a variation of Scenario 2.

### USHE Illustrative Model

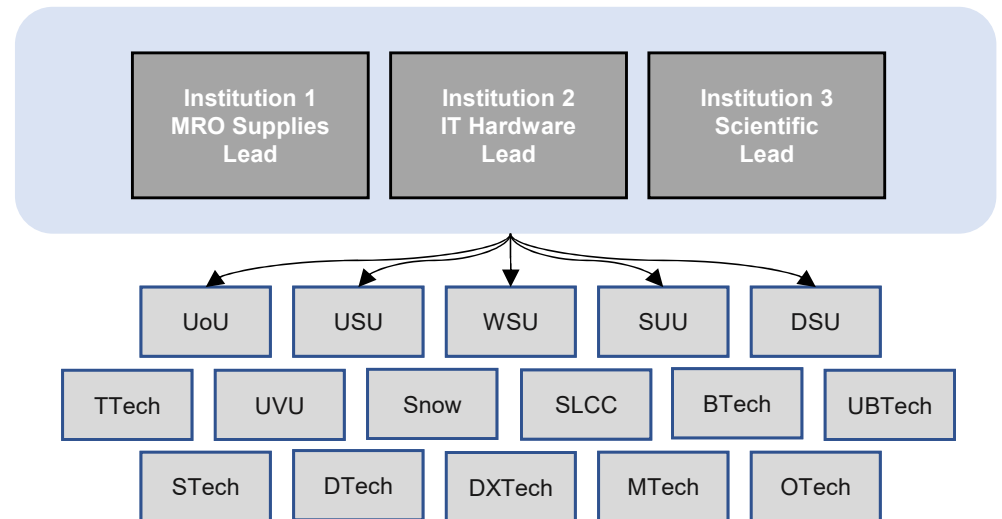

# Scenario 3: Institution Support for Key Categories



Operating Model Considerations																																																																	
	Considerations	Impact	Comments																																																														
<b>Resource</b>	FTE efficiency opportunity	🕒	<ul style="list-style-type: none"> <li>Leverages existing spend category expertise across all other institutions.</li> </ul>																																																														
<b>Process</b>	Standardized procurement processes	🕒	<ul style="list-style-type: none"> <li>Standardized sourcing and contracts approach for select spend categories. No duplicated efforts would occur within the select categories.</li> </ul>																																																														
<b>Technology</b>	Standardized procurement tools	🕒	<ul style="list-style-type: none"> <li>Common system using JAGGAER for Sourcing and Contracts for all institutions, increased automation and collaboration.</li> </ul>																																																														
	Spend reporting	🕒	<ul style="list-style-type: none"> <li>Increased spend visibility for institutions across select categories.</li> </ul>																																																														
<b>Service</b>	Improved service to campus	🕒	<ul style="list-style-type: none"> <li>Approval and purchasing process enhanced using negotiated agreements.</li> </ul>																																																														
	Needs of each campus tailored	🕒	<ul style="list-style-type: none"> <li>Institutions provide input on needs for categories led by other institutions, but concerns may exist that their needs take a back seat to the lead institutions..</li> </ul>																																																														
<b>Spend Savings</b>	Sourcing savings opportunities	🕒	<ul style="list-style-type: none"> <li>Enhanced purchasing power and proactive category strategies within select categories, estimated \$3M - \$7M in sourcing savings.</li> </ul>																																																														
	Collaboration	🕒	<ul style="list-style-type: none"> <li>Participation from institutions on designated spend categories.</li> </ul>																																																														
<b>Change Management</b>	Communicate and implement change	🕒	<ul style="list-style-type: none"> <li>Moderate effort as this is a shift from current practices at the category level.</li> </ul>																																																														
<b>Implementation Cost and Timeline</b>	JAGGAER license cost	🕒	<ul style="list-style-type: none"> <li>\$175K - \$225K estimated annual system costs for Sourcing and Contracts based on a 5-year term. Existing customers to extend their contracts accordingly.</li> </ul>																																																														
	Implementation cost	🕒	<ul style="list-style-type: none"> <li>Cost range to be determined, includes technology and model implementation efforts.</li> </ul>																																																														
	FTE cost impact	🕒	<ul style="list-style-type: none"> <li>Likely need to provide additional FTE to support larger spend, requirements gathering and facilitation across all institutions in select categories, and potential backfill of other roles.</li> </ul>																																																														
	Implementation timeline	🕒	<table border="1"> <thead> <tr> <th rowspan="2">KEY ACTIVITIES</th> <th colspan="2">FY22</th> <th colspan="4">FY23</th> <th>FY24</th> </tr> <tr> <th>Q3</th> <th>Q4</th> <th>Q1</th> <th>Q2</th> <th>Q3</th> <th>Q4</th> <th>Q1</th> </tr> </thead> <tbody> <tr> <td>Finalize model</td> <td colspan="2">█</td> <td></td> <td></td> <td></td> <td></td> <td></td> </tr> <tr> <td>Identify resources</td> <td></td> <td colspan="2">█</td> <td></td> <td></td> <td></td> <td></td> </tr> <tr> <td>Develop operating procedures</td> <td></td> <td></td> <td colspan="2">█</td> <td></td> <td></td> <td></td> </tr> <tr> <td>Implement enabling technology</td> <td></td> <td></td> <td colspan="3">█</td> <td></td> <td></td> </tr> <tr> <td>Training</td> <td></td> <td></td> <td></td> <td colspan="2">█</td> <td></td> <td></td> </tr> <tr> <td>Deployment</td> <td></td> <td></td> <td></td> <td></td> <td colspan="3">█</td> </tr> </tbody> </table>	KEY ACTIVITIES	FY22		FY23				FY24	Q3	Q4	Q1	Q2	Q3	Q4	Q1	Finalize model	█							Identify resources		█						Develop operating procedures			█					Implement enabling technology			█					Training				█				Deployment					█	
KEY ACTIVITIES	FY22		FY23				FY24																																																										
	Q3	Q4	Q1	Q2	Q3	Q4	Q1																																																										
Finalize model	█																																																																
Identify resources		█																																																															
Develop operating procedures			█																																																														
Implement enabling technology			█																																																														
Training				█																																																													
Deployment					█																																																												

# Scenario 4: Complete Consolidation



## SCENARIO 4

### Overview

#### Bottom Line:

Choose this model if you want a fully consolidated procurement organization serving all institutions, maximizing opportunities for savings, service, and risk reduction.

#### Description:

**Strategic Sourcing:** Responsible for managing supplier relationships, category optimization/strategy, and supporting departmental needs for all institutions. Utilizes data to find opportunities for enterprise-wide agreements.

**Procurement Operations:** Provides customer service and support to departments and suppliers, supports purchases for all categories.

**Procurement Technology:** Support ongoing administration of procurement technology platforms, lead and support projects designed to implement changes or add functionality to the procurement technology platforms and support ongoing training efforts.

#### Higher Education Example:

The University of Colorado System Procurement Service Center (PSC) provides services related to spend management, contracting, procure-to-pay, and travel management activities.

### USHE Illustrative Model

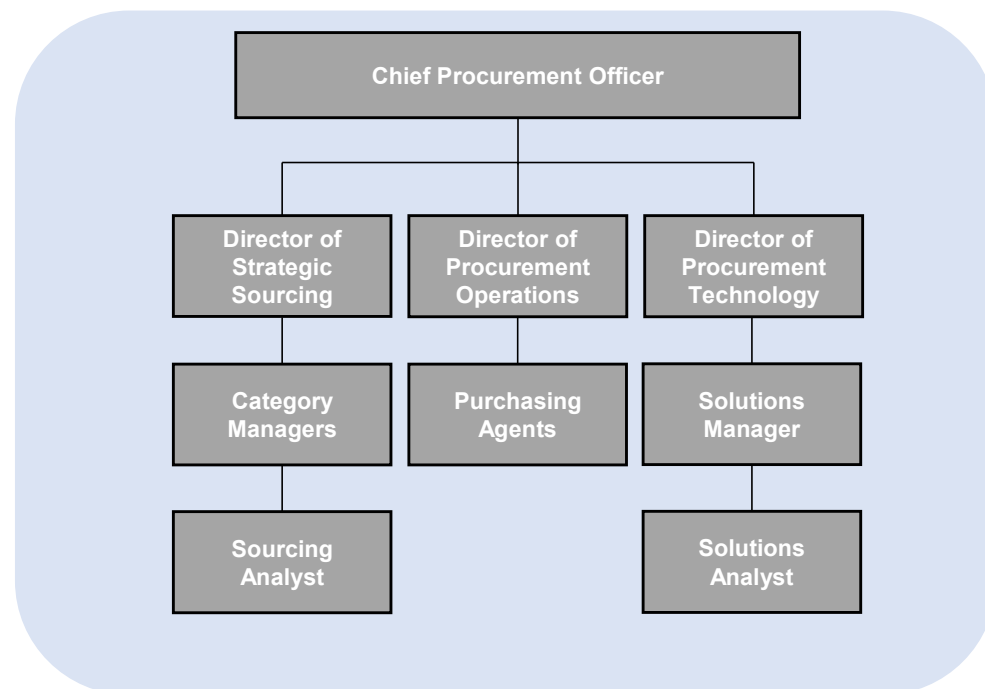

# Scenario 4: Complete Consolidation



		Operating Model Considerations																																																																				
		Considerations	Impact	Comments																																																																		
Resource	FTE efficiency opportunity		●	<ul style="list-style-type: none"> <li>Centralized resources responsible for entire consolidation of system spend providing labor efficiencies through standardization efforts.</li> </ul>																																																																		
	Process	Standardized procurement processes		●	<ul style="list-style-type: none"> <li>Standardized sourcing and contracts approach for all spend categories. No duplicated efforts would occur through consistent standards and controls.</li> </ul>																																																																	
Technology	Standardized procurement tools		●	<ul style="list-style-type: none"> <li>All institutions to use JAGGAER onto a shared instance (leveraging Multi-Business Unit functionality).</li> </ul>																																																																		
	Spend reporting		●	<ul style="list-style-type: none"> <li>Increased spend visibility across the system.</li> </ul>																																																																		
Service	Improved service to campus		◐	<ul style="list-style-type: none"> <li>Approval and purchasing process enhanced using negotiated agreements and enhanced technology solution and provides greater category expertise.</li> </ul>																																																																		
	Needs of each campus tailored		◑	<ul style="list-style-type: none"> <li>Individual institutions would have less independence, but service center would focus on understanding and supporting their needs.</li> </ul>																																																																		
Spend Savings	Sourcing savings opportunities		●	<ul style="list-style-type: none"> <li>Maximizes purchasing power, estimated \$6M - \$12M in sourcing savings.</li> </ul>																																																																		
	Collaboration		●	<ul style="list-style-type: none"> <li>Participation from all institutions on spend categories and procurement operations.</li> </ul>																																																																		
Change Management	Communicate and implement change		●	<ul style="list-style-type: none"> <li>Large effort as this is a major shift from current practices.</li> </ul>																																																																		
Implementation Cost and Timeline	JAGGAER license cost		●	<ul style="list-style-type: none"> <li>\$850K - \$900K additional annual cost to existing license fees for all institutions to join a shared instance. Based on a 5-year term, requiring existing customers to extend their contracts.</li> </ul>																																																																		
	Implementation cost		●	<ul style="list-style-type: none"> <li>Cost range to be determined, includes technology and model implementation efforts.</li> </ul>																																																																		
	FTE cost impact		●	<ul style="list-style-type: none"> <li>Estimated 30-60% total reduction of procurement resources through efficiencies gained as the model matures.</li> </ul>																																																																		
	Implementation timeline		●	<table border="1"> <thead> <tr> <th rowspan="2">KEY ACTIVITIES</th> <th colspan="2">FY22</th> <th colspan="4">FY23</th> <th>FY24</th> </tr> <tr> <th>Q3</th> <th>Q4</th> <th>Q1</th> <th>Q2</th> <th>Q3</th> <th>Q4</th> <th>Q1</th> </tr> </thead> <tbody> <tr> <td>Finalize model</td> <td colspan="2">██████████</td> <td></td> <td></td> <td></td> <td></td> <td></td> </tr> <tr> <td>Identify resources</td> <td></td> <td colspan="2">██████████</td> <td></td> <td></td> <td></td> <td></td> </tr> <tr> <td>Develop operating procedures</td> <td></td> <td></td> <td colspan="2">██████████</td> <td></td> <td></td> <td></td> </tr> <tr> <td>Implement enabling technology/model</td> <td></td> <td></td> <td></td> <td colspan="3">██████████</td> <td></td> </tr> <tr> <td>Training</td> <td></td> <td></td> <td></td> <td></td> <td></td> <td colspan="2">██████████</td> </tr> <tr> <td>Deployment</td> <td></td> <td></td> <td></td> <td></td> <td></td> <td></td> <td>██████████</td> </tr> </tbody> </table>					KEY ACTIVITIES	FY22		FY23				FY24	Q3	Q4	Q1	Q2	Q3	Q4	Q1	Finalize model	██████████							Identify resources		██████████						Develop operating procedures			██████████					Implement enabling technology/model				██████████				Training						██████████		Deployment						
KEY ACTIVITIES	FY22		FY23				FY24																																																															
	Q3	Q4	Q1	Q2	Q3	Q4	Q1																																																															
Finalize model	██████████																																																																					
Identify resources		██████████																																																																				
Develop operating procedures			██████████																																																																			
Implement enabling technology/model				██████████																																																																		
Training						██████████																																																																
Deployment							██████████																																																															

# Scenario 5: Consolidate with UofU / USU Participation



## SCENARIO 5

### Overview

#### Bottom Line:

Choose this model if you want a fully consolidated organization, maximizing opportunities for cost savings and consistency within policies and procedures while allowing for larger institutions, such as University of Utah and Utah State to maintain their internal procurement teams due to their size and needs.

#### Description:

Service center to support all sourcing, contracting, and procurement activities for all other institutions. Provides and support technology solution, system-wide contracts, training, expert purchasing knowledge across all categories, provides and enforces policies, etc. UofU and USU would maintain its own buying functions but would collaborate closely with the procurement service center.

#### Higher Education Example:

The University of Wisconsin System office of procurement provides systemwide procurement leadership, guidance, and advocacy. It offers authority on procurement policies and practices for the entire UW System, maximizes procurement resources through collaboration across the UW System and identifies enterprise-wide cost saving and strategic contracting opportunities. UW-Madison and UW-Milwaukee maintain their own purchasing organizations but collaborate with UW System procurement.

### USHE Illustrative Model

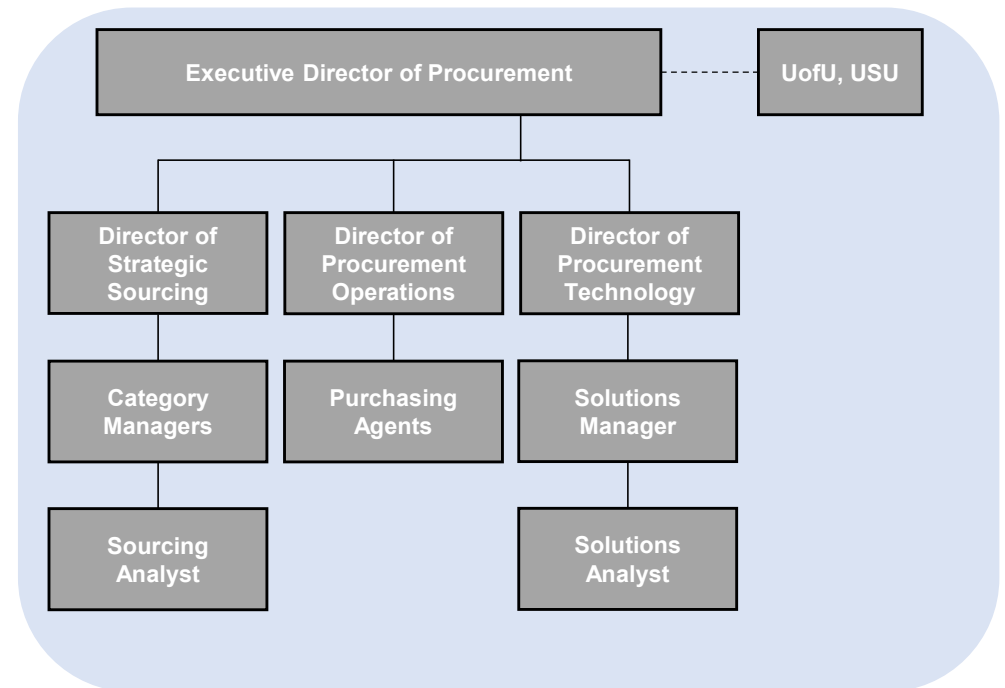

# Scenario 5: Consolidate with UofU / USU Participation



## Operating Model Considerations

	Considerations	Impact	Comments																																																														
<b>Resource</b>	FTE efficiency opportunity	🕒	<ul style="list-style-type: none"> <li>Centralized resources responsible for consolidated system spend, excluding UofU and USU, providing labor efficiencies through standardization efforts.</li> </ul>																																																														
<b>Process</b>	Standardized procurement processes	🕒	<ul style="list-style-type: none"> <li>Standardized sourcing and contracts approach for all spend categories. Limited duplication efforts would occur through separate control of UofU and USU processes.</li> </ul>																																																														
<b>Technology</b>	Standardized procurement tools	●	<ul style="list-style-type: none"> <li>All institutions to use JAGGAER onto a shared instance (leveraging Multi-Business Unit functionality).</li> </ul>																																																														
	Spend reporting	●	<ul style="list-style-type: none"> <li>Increased spend visibility across the system.</li> </ul>																																																														
<b>Service</b>	Improved service to campus	●	<ul style="list-style-type: none"> <li>Approval and purchasing process enhanced using negotiated agreements and enhanced technology solution and provides greater category expertise.</li> </ul>																																																														
	Needs of each campus tailored	●	<ul style="list-style-type: none"> <li>Large institutions, such as UofU and USU would maintain a level of independence, although participation in system-wide sourcing efforts is highly encouraged.</li> </ul>																																																														
<b>Spend Savings</b>	Sourcing savings opportunities	🕒	<ul style="list-style-type: none"> <li>Enhances system purchasing power, estimated \$5M - \$10M in sourcing savings.</li> </ul>																																																														
	Collaboration	🕒	<ul style="list-style-type: none"> <li>Participation from institutions on spend categories, including UofU and USU.</li> </ul>																																																														
<b>Change Management</b>	Communicate and implement change	●	<ul style="list-style-type: none"> <li>Large effort as this is a major shift from current practices for most institutions. Uof U and USU would be a moderate impact as they would maintain their own procurement resources.</li> </ul>																																																														
<b>Implementation Cost and Timeline</b>	JAGGAER license cost	●	<ul style="list-style-type: none"> <li>\$850K - \$900K additional annual cost to existing license fees for all institutions to join a shared instance. Based on a 5-year term, requiring existing customers to extend their contracts.</li> </ul>																																																														
	Implementation cost	●	<ul style="list-style-type: none"> <li>Cost range to be determined, includes technology and model implementation efforts.</li> </ul>																																																														
	FTE cost impact	🔴	<ul style="list-style-type: none"> <li>Estimated 20-40% total reduction of procurement resources through efficiencies gained as the model matures. Reduced opportunity from UofU / USU maintaining separate resources.</li> </ul>																																																														
	Implementation timeline	●	<table border="1"> <thead> <tr> <th rowspan="2">KEY ACTIVITIES</th> <th colspan="2">FY22</th> <th colspan="4">FY23</th> <th>FY24</th> </tr> <tr> <th>Q3</th> <th>Q4</th> <th>Q1</th> <th>Q2</th> <th>Q3</th> <th>Q4</th> <th>Q1</th> </tr> </thead> <tbody> <tr> <td>Finalize model</td> <td colspan="2">██████████</td> <td></td> <td></td> <td></td> <td></td> <td></td> </tr> <tr> <td>Identify resources</td> <td></td> <td>██████████</td> <td></td> <td></td> <td></td> <td></td> <td></td> </tr> <tr> <td>Develop operating procedures</td> <td></td> <td></td> <td>██████████</td> <td></td> <td></td> <td></td> <td></td> </tr> <tr> <td>Implement enabling technology/model</td> <td></td> <td></td> <td></td> <td>██████████</td> <td>██████████</td> <td></td> <td></td> </tr> <tr> <td>Training</td> <td></td> <td></td> <td></td> <td></td> <td></td> <td>██████████</td> <td></td> </tr> <tr> <td>Deployment</td> <td></td> <td></td> <td></td> <td></td> <td></td> <td></td> <td>██████████</td> </tr> </tbody> </table>	KEY ACTIVITIES	FY22		FY23				FY24	Q3	Q4	Q1	Q2	Q3	Q4	Q1	Finalize model	██████████							Identify resources		██████████						Develop operating procedures			██████████					Implement enabling technology/model				██████████	██████████			Training						██████████		Deployment						
KEY ACTIVITIES	FY22		FY23				FY24																																																										
	Q3	Q4	Q1	Q2	Q3	Q4	Q1																																																										
Finalize model	██████████																																																																
Identify resources		██████████																																																															
Develop operating procedures			██████████																																																														
Implement enabling technology/model				██████████	██████████																																																												
Training						██████████																																																											
Deployment							██████████																																																										

# Scenario 6: Consolidate Based on Institution Commonality



## SCENARIO 6

### Overview

#### Bottom Line:

Choose this model if you want to consolidate based on commonality among the institutions or based on regions. This allows for collaboration to be tailored to needs of institutions by type while generating savings and gaining process efficiencies.

#### Description:

Establish shared service centers based on institutional grouping, offering collaboration on sourcing, policies and procedures, and contracting within the assigned groups. UofU and USU would maintain their own procurement teams while working jointly with the other schools.

#### Higher Education Example:

This is an alternate approach to the fully consolidated model.

### USHE Illustrative Model

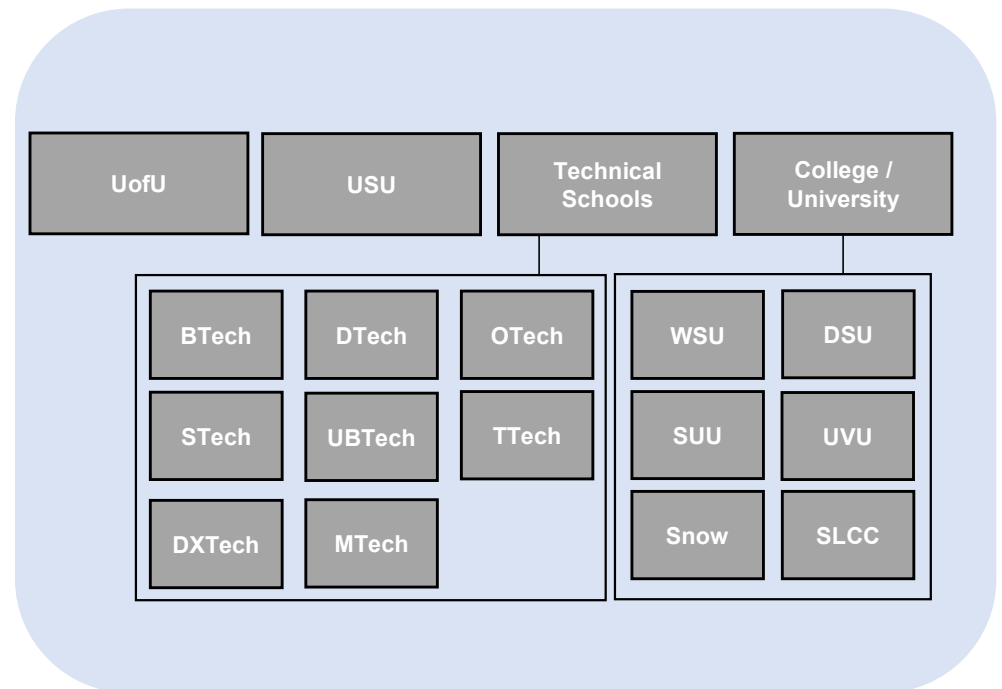









# Scenario 6: Consolidate Based on Commonality



		Operating Model Considerations																																																																						
		Considerations	Impact	Comments																																																																				
Resource	FTE efficiency opportunity		●	<ul style="list-style-type: none"> <li>Multiple centralized teams responsible for consolidated system spend, based on institution commonality, providing labor efficiencies through standardization efforts.</li> </ul>																																																																				
Process	Standardized procurement processes		●	<ul style="list-style-type: none"> <li>Standardized sourcing and contracts approach for all spend categories. Limited duplication efforts would occur through separate centralized teams and processes.</li> </ul>																																																																				
Technology	Standardized procurement tools		●	<ul style="list-style-type: none"> <li>All institutions to use JAGGAER onto a shared instance (leveraging Multi-Business Unit functionality).</li> </ul>																																																																				
	Spend reporting		●	<ul style="list-style-type: none"> <li>Increased spend visibility across the system.</li> </ul>																																																																				
Service	Improved service to campus		●	<ul style="list-style-type: none"> <li>Approval and purchasing process enhanced using negotiated agreements and enhanced technology solution and provides greater category expertise.</li> </ul>																																																																				
	Needs of each campus tailored		●	<ul style="list-style-type: none"> <li>Centralized teams can tailor requirements to the set of designated institutions that are grouped based on commonality.</li> </ul>																																																																				
Spend Savings	Sourcing savings opportunities		●	<ul style="list-style-type: none"> <li>Maximizes purchasing power, estimated \$4M - \$8M in sourcing savings.</li> </ul>																																																																				
	Collaboration		●	<ul style="list-style-type: none"> <li>Participation within institutional grouping, with cross-collaboration when possible.</li> </ul>																																																																				
Change Management	Communicate and implement change		●	<ul style="list-style-type: none"> <li>Large effort as this is a major shift from current practices.</li> </ul>																																																																				
Implementation Cost and Timeline	JAGGAER license cost		●	<ul style="list-style-type: none"> <li>\$850K - \$900K additional annual cost to existing license fees for all institutions to join a shared instance. Based on a 5-year term, requiring existing customers to extend their contracts.</li> </ul>																																																																				
	Implementation cost		●	<ul style="list-style-type: none"> <li>Cost range to be determined, includes technology and model implementation efforts.</li> </ul>																																																																				
	FTE cost impact		●	<ul style="list-style-type: none"> <li>Estimated 10-30% total reduction of procurement resources through efficiencies gained as the model matures. Reduced opportunity with having multiple centralized teams.</li> </ul>																																																																				
	Implementation timeline		●	<table border="1"> <thead> <tr> <th rowspan="2">KEY ACTIVITIES</th> <th colspan="2">FY22</th> <th colspan="4">FY23</th> <th>FY24</th> </tr> <tr> <th>Q3</th> <th>Q4</th> <th>Q1</th> <th>Q2</th> <th>Q3</th> <th>Q4</th> <th>Q1</th> </tr> </thead> <tbody> <tr> <td>Finalize model</td> <td colspan="2">██████████</td> <td></td> <td></td> <td></td> <td></td> <td></td> </tr> <tr> <td>Identify resources</td> <td></td> <td></td> <td colspan="2">██████████</td> <td></td> <td></td> <td></td> </tr> <tr> <td>Develop operating procedures</td> <td></td> <td></td> <td></td> <td colspan="2">██████████</td> <td></td> <td></td> </tr> <tr> <td>Implement enabling technology/model</td> <td></td> <td></td> <td></td> <td></td> <td colspan="3">██████████</td> </tr> <tr> <td>Training</td> <td></td> <td></td> <td></td> <td></td> <td></td> <td></td> <td>██████████</td> </tr> <tr> <td>Deployment</td> <td></td> <td></td> <td></td> <td></td> <td></td> <td></td> <td>██████████</td> </tr> </tbody> </table>							KEY ACTIVITIES	FY22		FY23				FY24	Q3	Q4	Q1	Q2	Q3	Q4	Q1	Finalize model	██████████							Identify resources			██████████					Develop operating procedures				██████████				Implement enabling technology/model					██████████			Training							██████████	Deployment						
KEY ACTIVITIES	FY22		FY23				FY24																																																																	
	Q3	Q4	Q1	Q2	Q3	Q4	Q1																																																																	
Finalize model	██████████																																																																							
Identify resources			██████████																																																																					
Develop operating procedures				██████████																																																																				
Implement enabling technology/model					██████████																																																																			
Training							██████████																																																																	
Deployment							██████████																																																																	

# Summary: Future State Scenarios

Scenarios	Overall Impact	Benefits	Risks
Scenario 1		<ul style="list-style-type: none"> <li>More control for institutions to work together on sourcing events</li> <li>Low impact to current state</li> </ul>	<ul style="list-style-type: none"> <li>Missed collaboration opportunities</li> <li>Duplicative sourcing and bidding processes</li> <li>Tools are not standardized</li> </ul>
Scenario 2		<ul style="list-style-type: none"> <li>Collaboration on designated spend categories, driving increased savings opportunities</li> <li>Common systems for Sourcing and Contracts</li> </ul>	<ul style="list-style-type: none"> <li>Process and category expertise depends on strong direction from USHE</li> <li>Moderate implementation costs and change mgmt.</li> </ul>
Scenario 3		<ul style="list-style-type: none"> <li>Collaboration on designated spend categories, driving increased savings opportunities</li> <li>Common systems for Sourcing and Contracts</li> </ul>	<ul style="list-style-type: none"> <li>Process and category expertise depends on strong direction from designated universities, potentially adding workload on existing institutional resources.</li> </ul>
Scenario 4		<ul style="list-style-type: none"> <li>Greater ease to develop and maintain unified strategy</li> <li>Center of policies, process, and enforcement; eliminate duplicate tasks; maximize savings; category expertise</li> <li>Shared instance of JAGGAER</li> </ul>	<ul style="list-style-type: none"> <li>Perception of service relationship vs. partner relationship</li> <li>Change management needs for new model</li> <li>Major system and process change</li> <li>Overall cost to implement</li> </ul>
Scenario 5		<ul style="list-style-type: none"> <li>Needs of large institutions like UofU and USU covered</li> <li>Center of policies, process, and enforcement</li> <li>Shared instance of JAGGAER</li> <li>Savings opportunities through collaboration</li> </ul>	<ul style="list-style-type: none"> <li>Need strong collaboration between UofU, USU and system</li> <li>Change management needs for new model</li> <li>Major system and process change</li> <li>Overall cost to implement</li> </ul>
Scenario 6		<ul style="list-style-type: none"> <li>Tailored to needs of institutions by common type</li> <li>Centers of policies, process, and enforcement</li> <li>Shared instance of JAGGAER</li> <li>Savings opportunities through collaboration by type</li> </ul>	<ul style="list-style-type: none"> <li>Segmenting institutions could lead to duplicative efforts, missed opportunities</li> <li>Change management needs for new model</li> <li>Major system and process change</li> <li>Overall cost to implement</li> </ul>

# Procurement Model Path Forward

When considering a shift in procurement, USHE must consider a variety of next steps and strategies to plan, select, and implement a new operating model (depending on scenario selected).

Phase	Planning		Selection / Refinement		Implementation / Deployment	
Timeline	Months 1 – 3		Months 4 - 6		Months 7 - 18	
Key Activities	Collaborative working sessions to narrow down model scenarios based on USHE goals Develop conceptual and detailed model designs Determine technology requirements		Select scenario to implement Select technology model Identify resources Develop operating procedures and consolidated policies (depending on model)		Implement technology Shift resources (depending on model) Conduct training Deploy Continuous improvement	
Key Risks	<p><b>Change management:</b> A large shift in procurement operating models needs connection with stakeholders to promote buy-in by connecting their individual goals with the institutions change goals</p> <p><b>Related Functions and Processes:</b> Processes including accounts payable, card programs, and travel/expense may be impacted and should be addressed as part of determining and refining the go-forward model prior to implementation</p> <p><b>Service Quality:</b> A successful transition to a more collaborative procurement model will require reinforcement on procurement’s mission focusing on the value proposition to campuses and establishing service level agreements in a service model</p>					

# 5

---

## Payroll

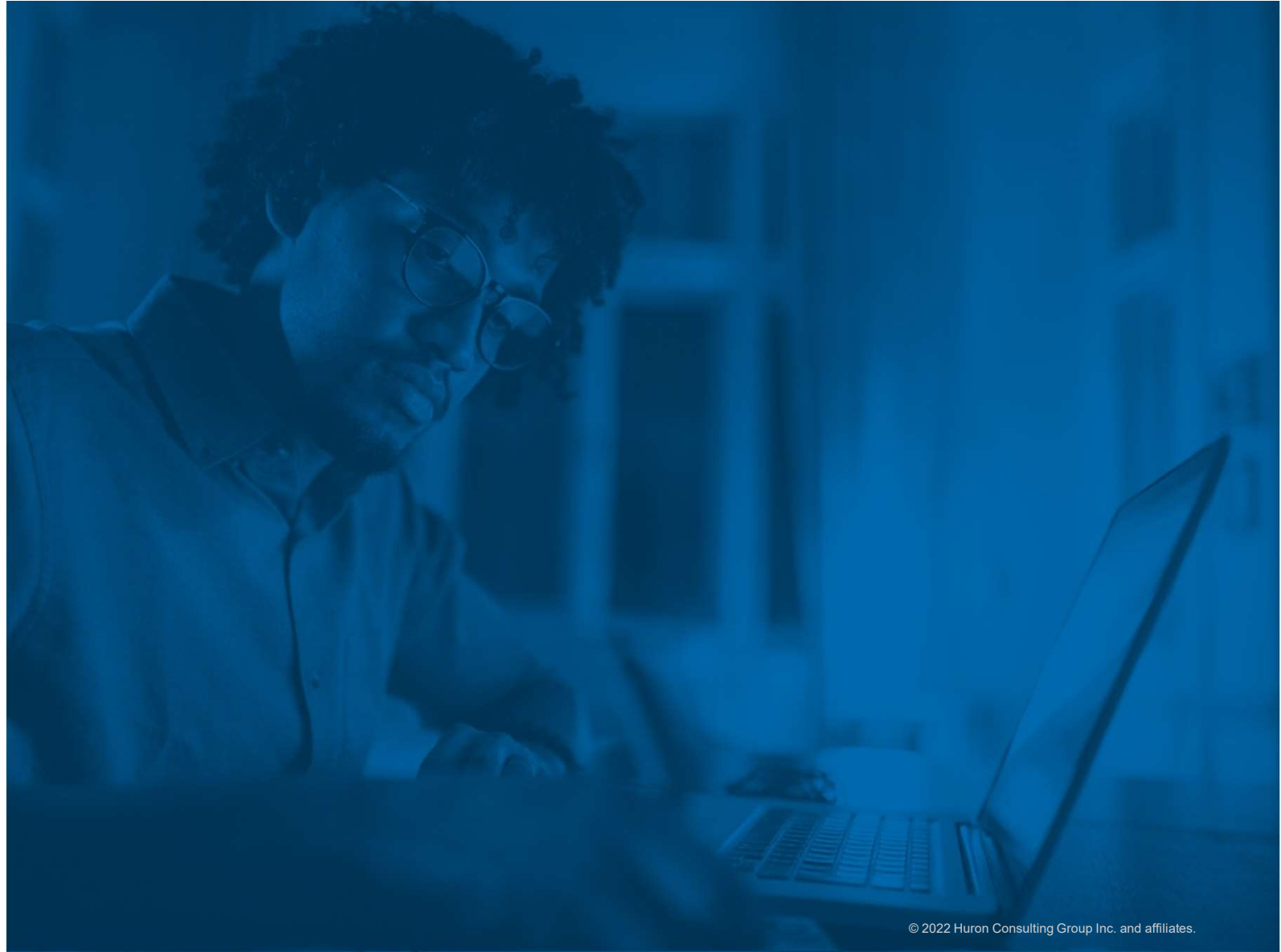

# Overview of Opportunity

USHE currently pays a premium for payroll services and spends above benchmarks. Payroll services are routine and process-based, making them candidates for outsourcing or shared services.

## Executive Summary

- USHE **underperforms key benchmarks**, such as cost per paycheck where USHE **spends 30% more**, which indicates opportunities for improvement
  - These **opportunities are both local and systemwide** with select 4-year institutions having high costs and technical colleges generally being above cost benchmarks
- Institutions have substantially **different operating profiles and systems** for delivering payroll, creating risk and posing challenges for centralization
- The activities of payroll processing make it **a candidate for either shared services or for outsourcing**; many institutions either partially outsource or fully use shared services for payroll

## Opportunities Assessed

1

### Creating a Technical College Payroll Shared Service Center

Transitioning payroll service delivery to a shared service center would reduce local administrative burden and address service quality challenges

2

### Outsource Payroll

Outsourcing all payroll services across USHE would standardize service quality, mitigate risk, create cost savings, and offload the challenging standardization process to an experienced third party

# Payroll Life Cycle

The activities listed below are commonly associated the payroll life cycle. Stages 2 and 3, or payroll calculations and post payroll, are well suited for shared services and outsourcing.

Payroll Stages

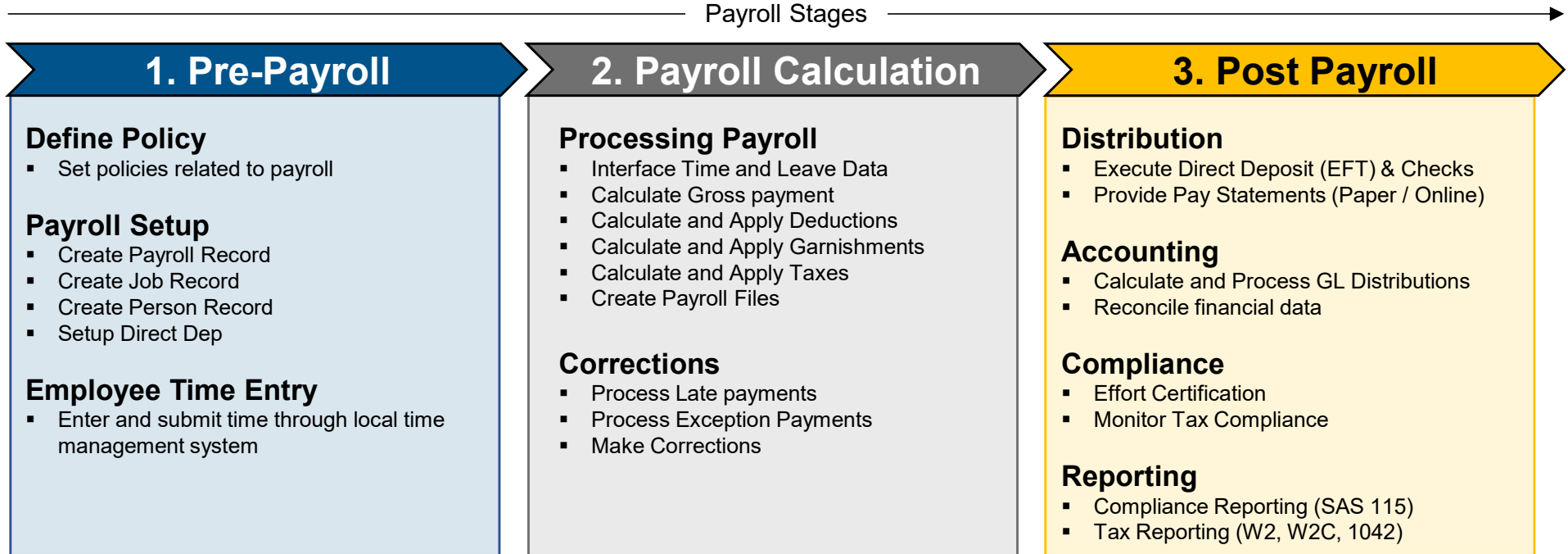

# Higher Education Payroll Services Comparison

Institutions currently provide most typical services in higher education payroll services, however, the USHE office has little to no involvement with the current campus processes.

Common Services Provided	Institutional Offering?	USHE Involvement?
Shared Services model for Payroll and Employee Service	Few	None
Usage of an ERP system	Most	None
Existence/adoption of online self service tools	Most	None
Relatively complex pay calendar	Most	None
Complex processing around Grants and funding of academic and research appointments	Few	None
Systematic tracking of Time & Labor data and Sick/Vacation balances	Most	None
Usage of Outsourcing for Payroll-related services	Few	None

“We can cut the checks, but that’s about it. We are limited by our lack of IT resources and our manual processes.”

# Payroll Systems

USHE institutions operate with a variety of systems to support payroll, creating long-term risks of continued systems, process, and compliance drift, factors which all can increase operating costs.

Institution	Payroll Processing System
Bridgerland Technical College	Jenzabar
Davis Technical College	Outsourced
Dixie State University	Banner
Dixie Technical College	iSolved
Mountainland Technical College	iSolved
Ogden-Weber Technical College	ADP
Salt Lake Community College	Banner
Snow College	Banner + Evisions
Southern Utah University	Banner
Southwest Technical College	Quickbooks
Tooele Technical College	Kony
Uintah Basin Technical College	iSolved
University of Utah	PeopleSoft
Utah State University	Banner
Utah Valley University	Banner
Weber State University	Banner



## Systems:

The sixteen USHE institutions use nine unique systems for processing payroll, not including ancillary systems and processes.



## Risk Factors:

The variety of payroll systems reduce payroll processing expertise, result in cost inefficiencies from ineffective use of scale, and create challenges in reporting, compliance, and monitoring at the system level.



## Change Considerations:

Without efforts to standardize, processes and systems are likely to further drift, creating obstacles for future System alignment. This is already evidenced by the technical colleges' six unique systems.



# Cost of Payroll Operations

USHE institutions collectively spend \$6.3M annually administering payroll<sup>1</sup>. Benchmarks show that USHE operations are more expensive than outsourcing and higher education benchmarks.

**Cost per Payment**

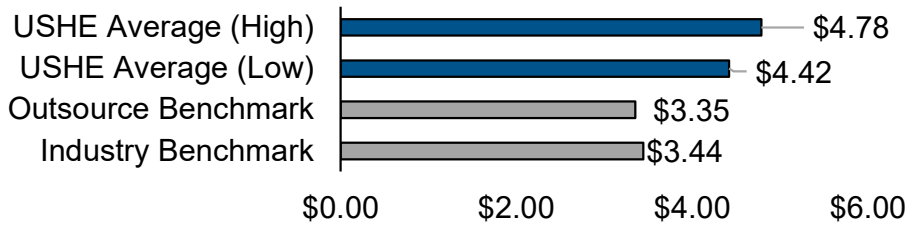

**Cost per Payee**

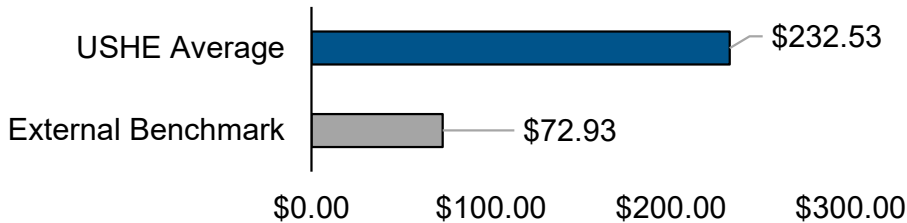

**Cost Contribution by Institution**

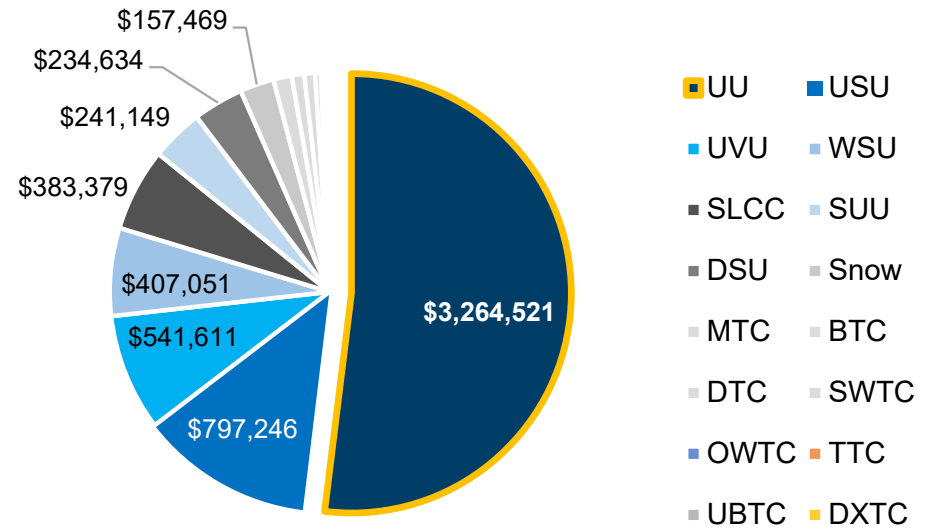

Source(s): Annual payroll spend based on HAAS survey data and does not include overhead or extrapolate for incomplete surveys (25%); <sup>2</sup>Benchmarking sources per the American Payroll Association and internal Huron data

# Payroll Efficiency

Payroll efficiency metrics are also below benchmarks, with the range in institutional FTE per payroll FTE ratios showing the relative efficiencies or inefficiencies between USHE institutions.

**Payees Processed per Payroll FTE**

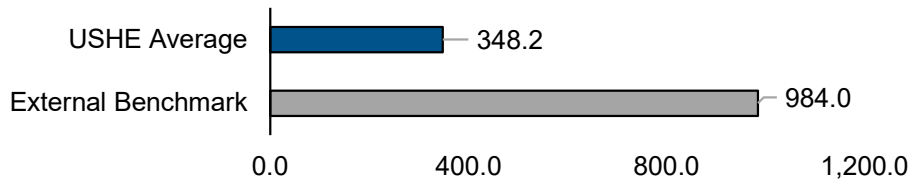

**Payments Processed per Payroll FTE**

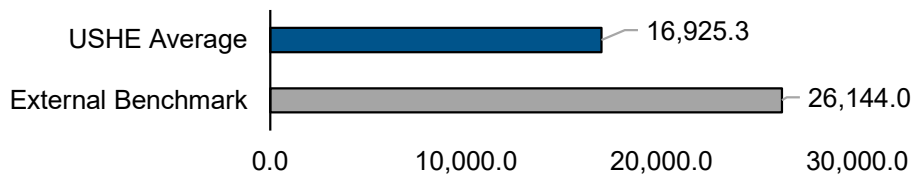

**Institutional FTE per Payroll FTE<sup>1</sup>**

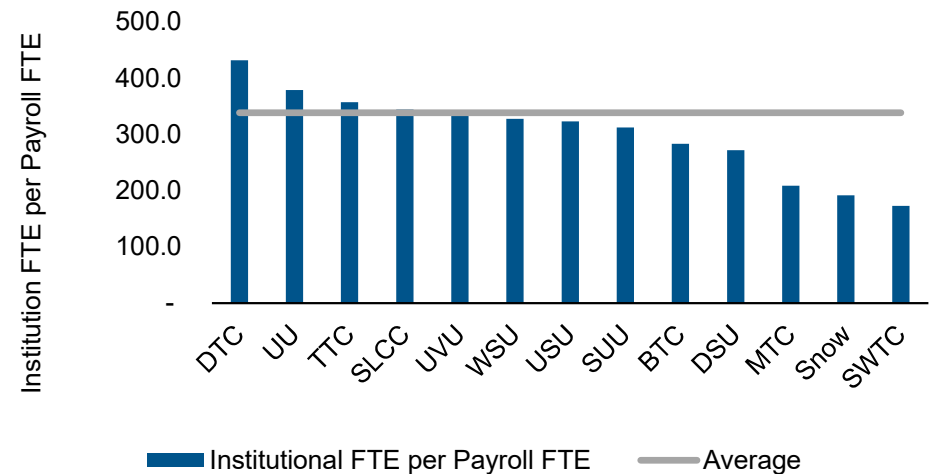

**The performance of payments processed per payroll FTE may indicate that USHE institutions are processing more payments than necessary, common for organizations with payroll quality issues.**

Note(s): <sup>1</sup>DXTC, UBTC, and OWTC are outlier data points and omitted from graph

# Cost and Administrative Support by Institution

Scale of payroll operations vary by institution, with a high of 35.2 FTE and a low of less than 1.0 FTE. Cost per paycheck substantially increases at institutions with smaller operating profiles.

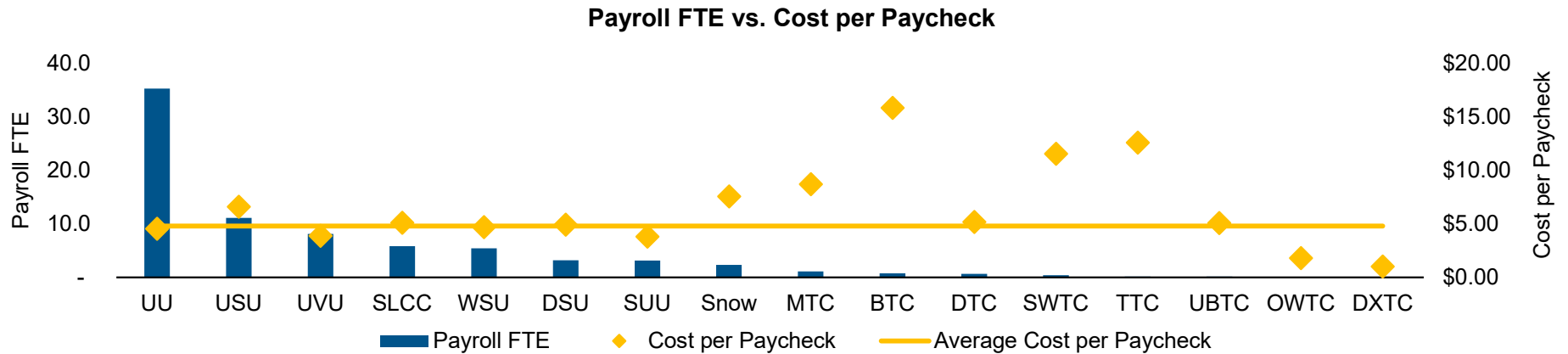

## Key Findings

- **14 of 16 institutions spend above the benchmark** for cost per paycheck, showing the opportunity for systemwide improvements
  - Technical colleges average cost per paycheck is **\$5.60 while the USHE average is \$4.78** suggesting there is opportunity to improve through scale
- **Payroll FTE support is low at the technical colleges**
    - The low FTE and high cost is an indicator that **senior staff members are performing basic payroll functions**
  - **USU has the highest cost per check of the four-year institutions**, suggesting there is the opportunity for local improvement

# Distribution of Payroll Processing Operations

Payroll processing excludes time and leave; only 60% of effort comes from HR and finance units, which are typically the central unit responsible for the activity.

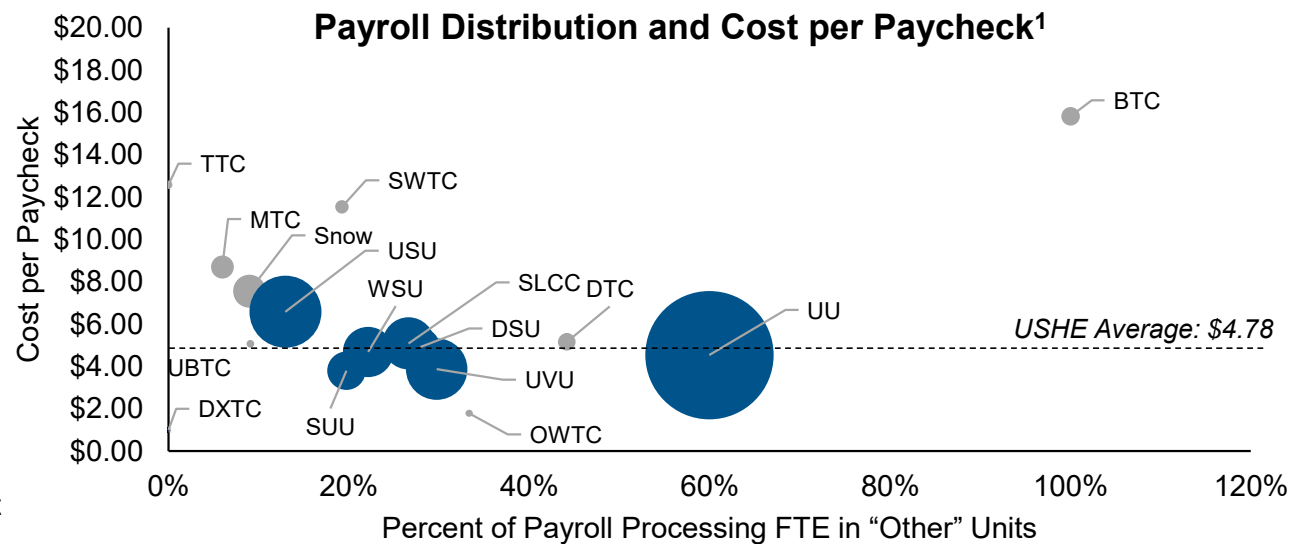
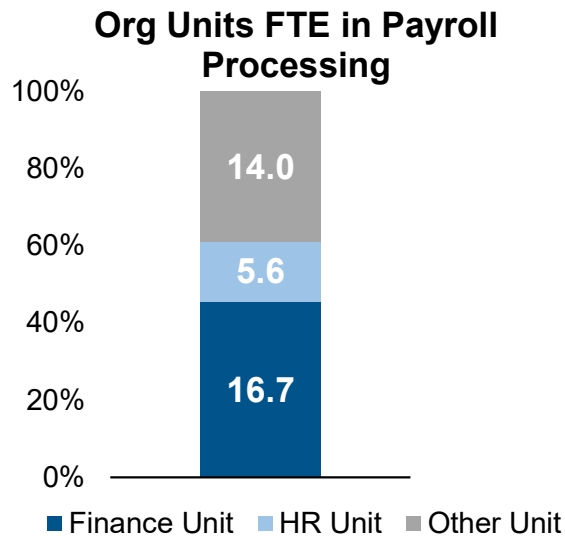





**The lower cost per paycheck in more distributed operations shows the impact of payroll complexity, possible inefficiencies with the central units, and risk factors from distributed activity.**

Note(s): <sup>1</sup>Bubble size is total payroll FTE

# Payroll Themes

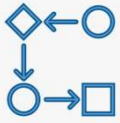
Current-state analysis and stakeholder feedback show the opportunity to reduce costs and improve service through operational improvements with the primary barriers being systems and governance,

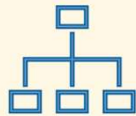
Challenges	<p><b>1</b></p>  <p><b>Cost Premium</b></p> <ul style="list-style-type: none"> <li>USHE pays above benchmarks for payroll services</li> <li>Six of eight technical colleges are above the USHE average</li> </ul>	<p><b>2</b></p>  <p><b>Inequitable Support</b></p> <ul style="list-style-type: none"> <li>Payroll staff is not consistent with institution size</li> <li>Service quality varies substantially across institutions</li> </ul>	<p><b>3</b></p>  <p><b>Inefficient Operations</b></p> <ul style="list-style-type: none"> <li>Support is decentralized</li> <li>Payees processed and payments processed are below benchmarks</li> </ul>
	Barriers	<p><b>4</b></p>  <p><b>Multiple Systems</b></p> <ul style="list-style-type: none"> <li>There is no common payroll system in use across institutions</li> <li>Foundational elements (ex: CoA) are not aligned</li> </ul>	<p><b>5</b></p>  <p><b>Governance</b></p> <ul style="list-style-type: none"> <li>USHE does not currently have the authority or legal ability to perform essential payroll tasks like check disbursements</li> </ul>

# Scenario 1: Technical College Shared Service Center

A shared service center that supports the technical colleges could provide an increased level of service while containing future costs.

## Case for Change

- Technical colleges **do not have enough support and have notable service limitations**, which creates risk
- Despite the low-level of funding, technical colleges **have a higher cost per payment** than the USHE average
- **Functional similarities** between the institutions make them a good fit for sharing services
- A shared service center will **contain costs, improve service quality, and offload administrative work** allowing staff to direct attention to more mission-centric activities

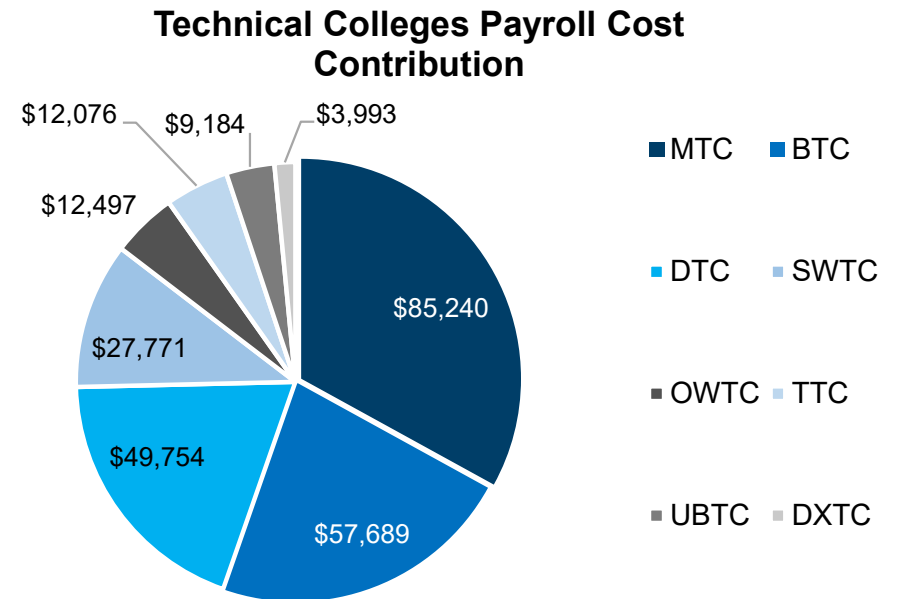

# Current-State Payroll Limitations

The technical colleges account for \$258.2K of payroll related expense and 3.3 of payroll FTE. They underperform benchmarks with a low level of service, which indicates suboptimal processes.

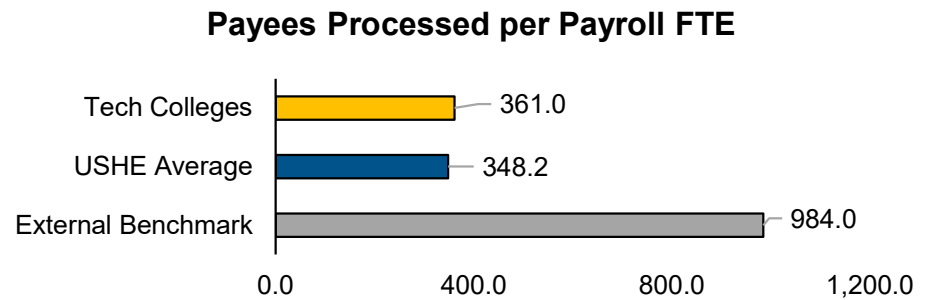
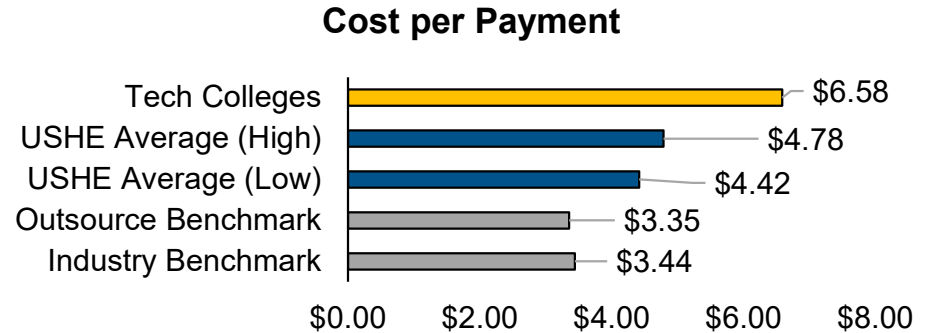
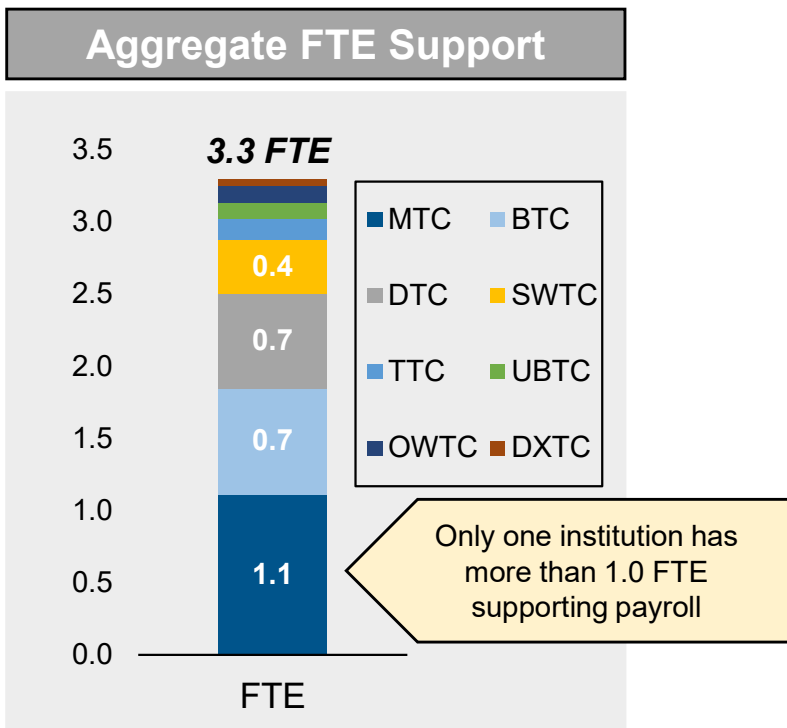

# Benefits of a Payroll Shared Service Center

Shared services addresses issues related to unstandardized processes and improves the level of service at a lower cost than current operations.

## Process and Policy Standardization

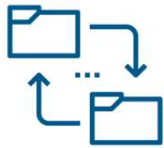

- The decentralized nature of payroll operations results in instances of **inefficient business processes** and **non-standard policy guidance**
- Centralizing payroll operations would help USHE **reduce and standardize payroll** across the technical colleges

## Cost Savings



- Managing payroll operations in-house **with high levels of service** is costly and requires **significant investment at an institutional-level**
- Shifting payroll operations to a shared service center with **payroll expertise can generate cost savings**

## Service Quality









- Decentralized payroll operations also can inhibit the ability to provide an **equal level of service** to institutions
- A shared service center will be able to navigate the **complexities and nuances** of payroll, crafting a higher level of service for the institution set



# Payroll Shared Service in Higher Education

Providing payroll through shared services is common among higher education institutions and higher education systems. A unified ERP is a common theme and supports efficient processing.

Seal / Logo	Institution Name	Services Provided
	The Texas A&M System	<ul style="list-style-type: none"> <li>Distributions, payroll processing, employment verifications, W-2s, standardized calendars and pay schedules, training, garnishments, Workday tools, payroll and employment related form repository</li> </ul>
	The University System of New Hampshire	<ul style="list-style-type: none"> <li>Distributions, corrections, general payroll processing (e.g. calculating and applying deductions, applying taxes etc.), tax reporting, compliance reporting, and reconciliations</li> </ul>
	The University System of Georgia	<ul style="list-style-type: none"> <li>Distributions, general payroll processing, employee self service through OneUSG connect, direct deposit forms and maintenance, exceptions log, systemwide policy, integrated service with benefits, and time and leave</li> </ul>
	The University of Michigan	<ul style="list-style-type: none"> <li>Payroll processing, distributions, customer service, timekeeping, tax, customer service support, and reporting</li> </ul>
	The University of Maine System	<ul style="list-style-type: none"> <li>Distributions, general payroll processing, responsible for accurate and efficient data entry with consistent standardized data entry practices, ensures compliance, W-2s, and manages related policies</li> </ul>
	The University System of Illinois	<ul style="list-style-type: none"> <li>Manages payroll schedules, earnings, deductions, taxes, and time reporting; the office also facilitates benefits enrollment of employees on each of the three universities</li> </ul>

# Shared Service Center Cost Analysis

Cost analysis shows that a shared service center with standard service offerings will provide cost containment and may yield savings while increasing the quality of services.

## Estimated Shared Service Center Cost

**1,000 FTE** for every one payroll FTE<sup>1</sup>

**\$78.4K** average cost per payroll FTE at USHE technical colleges

**\$81.0K** average cost per payroll FTE at all USHE institutions

**3.3K** approximate total technical college FTE<sup>2</sup>

**\$258K – \$267K** Estimate for annual cost of payroll shared service center for technical colleges

Note(s): <sup>1</sup>Total payroll expenditure increased by 25% from HAAS survey admin cost to account for survey participation (75%) and reduced overhead requirements  
Source(s): <sup>1</sup>APA; <sup>2</sup>IPEDS

Cost Categories	FTE	Compensation (\$)
<b>Payroll Expenditure</b>		
<i>MTC</i>	1.41	\$107.6K
<i>BTC</i>	0.91	\$72.1K
<i>DTC</i>	0.82	\$62.2K
<i>SWTC</i>	0.48	\$34.7K
<i>OWTC</i>	0.14	\$15.6K
<i>TTC</i>	0.18	\$15.1K
<i>UBTC</i>	0.15	\$11.5K
<i>DXTC</i>	0.04	\$5.0K
<b>Total Technical College Payroll Expenditure</b>	<b>4.12</b>	<b>\$322.8K</b>
<b>Shared Service Center</b>	<b>3.29</b>	<b>\$258K – \$267K</b>
<b>Savings (Investment)</b>	<b>0.83</b>	<b>\$55.8K - \$64.8K</b>

# Shared Services Next Steps and Risk Management

During implementation of a shared service center, USHE must consider a variety of next steps and strategies for mitigating any risks.

Phase	PLANNING		DESIGN		IMPLEMENTATION	
Timeline	Months 0 - 2		Months 3 - 6		Months 6 - 18	
Key Activities	<ul style="list-style-type: none"> <li>Conduct activity portfolio</li> <li>Conduct organizational mapping</li> <li>Develop future-state designs</li> </ul>		<ul style="list-style-type: none"> <li>Facilitate workgroups</li> <li>Catalogue recommended outcomes</li> <li>Process mapping</li> <li>Develop transition plan</li> </ul>		<ul style="list-style-type: none"> <li>Hire and onboard employees</li> <li>Communication and change management</li> <li>Systems updates</li> <li>Process transition and implementation</li> </ul>	
Key Risks	<p><b>Systems alignment:</b> Technical colleges will need to be transitioned to the same payroll systems, which has implications for ancillary systems and other structures that intersect with payroll processing</p> <p><b>Process diversity:</b> The current operating model has a diverse range of processes that would need to be standardized across the institutions</p> <p><b>Service quality:</b> The quality of payroll related services cannot decrease as a result of the initiative</p>					

# Scenario 2: Outsource Payroll

Outsourcing payroll services across all USHE institutions broadly addresses cost issues, releases time and capital for institutional priorities, and contracts expert services for a challenging project.

## Benchmark vs. Actuals

### Cost per Payment

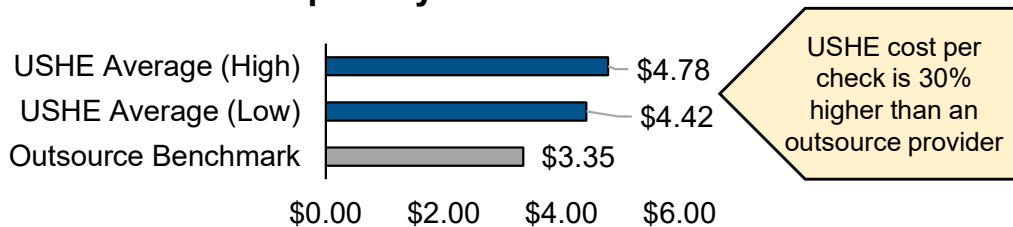

## Capital in Payroll

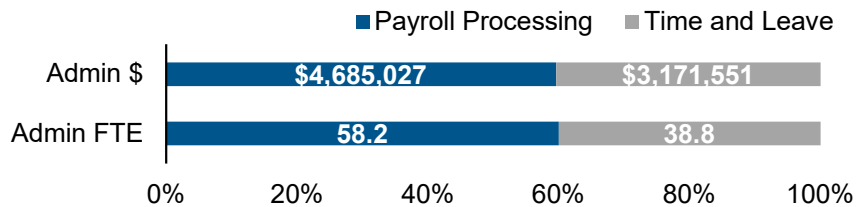

39.9% of payroll FTE is related to time and leave. Automation technology in the area should be considered

## Standardizing Processes

- A primary challenge in standardizing payroll operations will be **navigating the variety of systems, governance, and processes** in place across the sixteen institutions
- The sixteen **USHE institutions use a combined nine unique systems** for processing payroll, not including ancillary systems and processes
  - Stakeholders during interviews said that even when systems are the same, they are so customized to the institution that they are essentially unique
- USHE would require **additional legal and financial authority** as a governing body to disburse employee payments
- Using an **outsourced vendor resolves these complexities** by outsourcing the project work, align institutions on systems or develop work arounds, and does not have any of the associated governance complications with shared services





# Outsourcing Benefits

Outsourcing payroll services addresses issues related to unstandardized processes and improves the level of service at a lower cost than current operations.

- **Payroll Expertise:** Outsourced payroll providers work with a variety of clients and have nuanced and specialized expertise in the complexities of payroll processing, taxes, and relevant regulations
- **Standardization:** Shifting payroll responsibilities to an outside organization would create standardization across USHE institutions, allowing for the accurate maintenance of data and the creation of a high level of service
- **Time Saved:** For HR and payroll leaders, the time spent managing complex payroll requirements and time-intensive payroll processes can be diverted to mission-critical activities and institutional priorities
- **Cost Savings:** Outsourcing payroll generates cost savings by shifting away from managing all operations in-house; outsourcing payroll can also generate savings by avoiding any costs associated with acquiring and maintaining technology
- **Mistake Mitigation:** Mitigating mistakes can also generate cost savings and avoid frustration; inability to maintain accurate data can result in overpay, and violating reporting requirements can result in penalties
- **Security:** Outsourced payroll providers offer enhanced security for the confidential and sensitive data associated with payroll activities, providing an additional safeguard against cybersecurity risks
- **Compliance:** A professional payroll provider can help the System stay up to date on governmental regulations, as well as ensure accuracy when tracking employee data and monitoring deductions for federal, state, and local taxes
- **Technology:** Outsourced payroll providers stay up to date with advanced technology that today's employees expect, such as online payroll portals, mobile applications, and a Human Resource Information system

# Outsourced Payroll in Higher Education

While many institutions outsource some level of payroll services, higher education has resisted the complete outsourcing of payroll activities.

Seal / Logo	Institution Name	Outsourced Services Description
	Depauw University	<ul style="list-style-type: none"> <li>Access to pay statements, processing, changes to direct deposit information, access to W-2s, address updates, access timecards, register for benefits, and processing</li> </ul>
	Bradley University	<ul style="list-style-type: none"> <li>Payroll processing, self-service, W-2s, timecards, paystubs, time management</li> </ul>
	Virginia Wesleyan University	<ul style="list-style-type: none"> <li>Payroll processing, employee self service, manger self service</li> </ul>
	University of California	<ul style="list-style-type: none"> <li>Employee verification and data management</li> </ul>
	Kansas State University	<ul style="list-style-type: none"> <li>Outsourced an automated time and leave function, the project reduced payroll time by 78% and saved \$100K in overhead expenses</li> </ul>

## Higher Education Themes

- Employee self service is often outsourced
- Service providers offer customized solutions
- Outsourcing of employee documents with minimal customization (e.g., W-2s)

**15%** of higher education institutions outsource part of payroll services



# Recommended Outsourcing Vendor Requirements

Huron recommends outsourced vendors fulfill the requirements below, which are aligned with ensuring comprehensive capacity to support higher education institutions.

Functionality	Requirement Name	Detail
Vendor Requirement	Customer Service Portal	The vendor must have an adequate customer service portal
Vendor Requirement	Vendor Support	The vendor must be able to provide highly responsive support for the System and its employees
Vendor Requirement	Vendor Communication	The vendor must be able to accommodate the following forms of communication
Vendor Requirement	Payroll Compliance	The vendor must be compliant with all payroll rules, regulations, and laws
Vendor Requirement	Industry Experience	The vendor must have experience in higher education
Vendor Requirement	Vendor Location	The vendor must be based or have operations in the United States
Vendor Requirement	Processing Volume	The vendor must be able to process payroll for multiple employees
Vendor Requirement	Years in Business	The vendor must have at least five years in business
Vendor Requirement	Mobile app	The vendor must support a mobile friendly app for employee access
Vendor Requirement	Use of Own Service	The vendor must process their own payroll
Vendor Requirement	Tax Administration	The vendor must be able to handle tax administration
Vendor Requirement	Contingent / Temp Processing Support	The vendor must be able to support processing payroll for contingent and temporary employees
Dedicated Support	Implementation Management	The vendor must provide comprehensive implementation support
Integrations	Banner Integration	The vendor must have the ability to support seamless integration with Banner and other systems
Integrations	Transition & Implementation	The vendor must have the capacity to successfully implement on USHE's desired timeframe

## Vendor Scorecard

The vendors below all perform the requisite services for a successful outsourced payroll operation.

			
<b>Tax management and administration</b>	Yes	Yes	Yes
<b>Employee benefit administration</b>	Yes	Yes	Yes
<b>Garnishments and Deductions</b>	Yes	Yes	Yes
<b>Employee Self-Service</b>	Yes	Yes	Yes
<b>Monthly/Quarterly Reporting</b>	Yes	Yes	Yes



# Outsource Cost Analysis

Based on internal Huron sources and market analysis, USHE could save between \$284K and \$724K by outsourcing payroll, which represents a three to nine percent decrease in cost for payroll administration.

Cost Categories	FTE	Cost (\$)
<b>Payroll Expenditure</b>		
Total Payroll Expenditure <sup>1</sup>	97.0	\$7.9M
Less Time & Leave Expenditure <sup>2</sup>	38.8	\$3.2M
<b>Total Outsourceable Payroll Expenditure</b>	<b>58.2</b>	<b>\$4.7M</b>
<b>Outsource Costs</b>		
Annual Fee	-	\$4.0M – \$4.4M
Training and Implementation Expenses	-	\$1.5M - \$2.3M
<b>Total Outsourcing Costs (Y1)</b>	-	<b>\$5.5M – \$6.7M</b>
<b>Annual Savings<sup>3</sup></b>	-	<b>\$284K - \$724K</b>

Annual Fee Calculation
<b>Average Monthly EE:</b> 109,000
<b>Average Cost per EE:</b> \$3.02 - \$3.35
<b>Total Annual Fee:</b> \$3,961,000 – \$4,401,000

Note(s): <sup>1</sup>Total payroll expenditure increased by 25% from HAAS survey admin cost to account for survey participation (75%) and reduced overhead requirements; <sup>2</sup>Time & leave category from HAAS adjusted to reallocate payroll processing activity into outsourceable spend; <sup>3</sup>Annual savings excludes one-time costs like training and implementation

---

## Outsourcing Considerations and Limitations

Outsourcing payroll services comes with key limitations and considerations, as control is shifted to a private partner. Selecting the right service provider is key to a successful outsourcing initiative.

- **Service Quality:** If the optimal vendor is not selected, ideally one with experience in higher education, the System may experience difficulties in achieving a high level of service for its payroll operations
- **Data Privacy:** In selecting an outsourced payroll provider, the System must consider the organization's requirements for safety and compliance
- **Communication:** While payroll operations may be outsourced, there remains a need for a formal point of communication between USHE and the vendor, and a lack of clarity or attention in this area could result in inefficiencies
- **Identity and Culture:** Employees will have to adjust to service through an outside agency, which may have norms, standards, and processes that are different than an internal payroll structure
- **Loss of Control:** Outsourcing payroll can result in lessened authority over process-oriented decision-making and a narrow group of USHE staff having instant access to full data reporting

# Outsourcing Next Steps and Risk Management

When outsourcing payroll services, USHE must consider a variety of next steps and strategies for mitigating any risks.

Phase	PLANNING	DESIGN	IMPLEMENTATION
Timeline	Months 0 – 3	Months 3 - 6	Months 6 - 18
Key Activities	<ul style="list-style-type: none"> <li>Establish which services are best-fit for outsourcing</li> <li>Engage with stakeholders</li> <li>Inventory technologies supporting payroll</li> </ul>	<ul style="list-style-type: none"> <li>Issue RFI</li> <li>Hold informal discussion with vendors</li> <li>Issue RFP</li> <li>Review vendor quotes to decide whether to continue with outsourcing initiative</li> </ul>	<ul style="list-style-type: none"> <li>Determine if implementation partner is needed besides payroll vendor</li> <li>Select payroll outsource vendor and agree on scope of work</li> <li>Begin transition process</li> </ul>
Key Risks	<p><b>Vendor Selection:</b> Primary consideration should be given to the vendor and potential transition partner, as the project represents a long-term relationship with high employee impact</p> <p><b>Related Processes:</b> Processes that may appear unrelated to payroll may connect with the service in some way; USHE should identify these in order to minimize implementation disruptions</p> <p><b>Service Quality:</b> Maintaining a high quality of service is essential for a successful payroll transition; service quality cannot decline</p>		

# Summary Recommendations



1

## Create a Payroll Shared Service Center

Transition payroll service delivery to a shared service center for the technical colleges

Impact	Benefit
Service	High
Savings	\$55.8K - \$64.8K



2

## Outsource Payroll Across USHE Institutions

Transition payroll service delivery to an outsourced vendor for specified payroll activities

Impact	Benefit
Service	Moderate
Savings	\$284K - \$724K

# 6

---

## Compensation & Classification

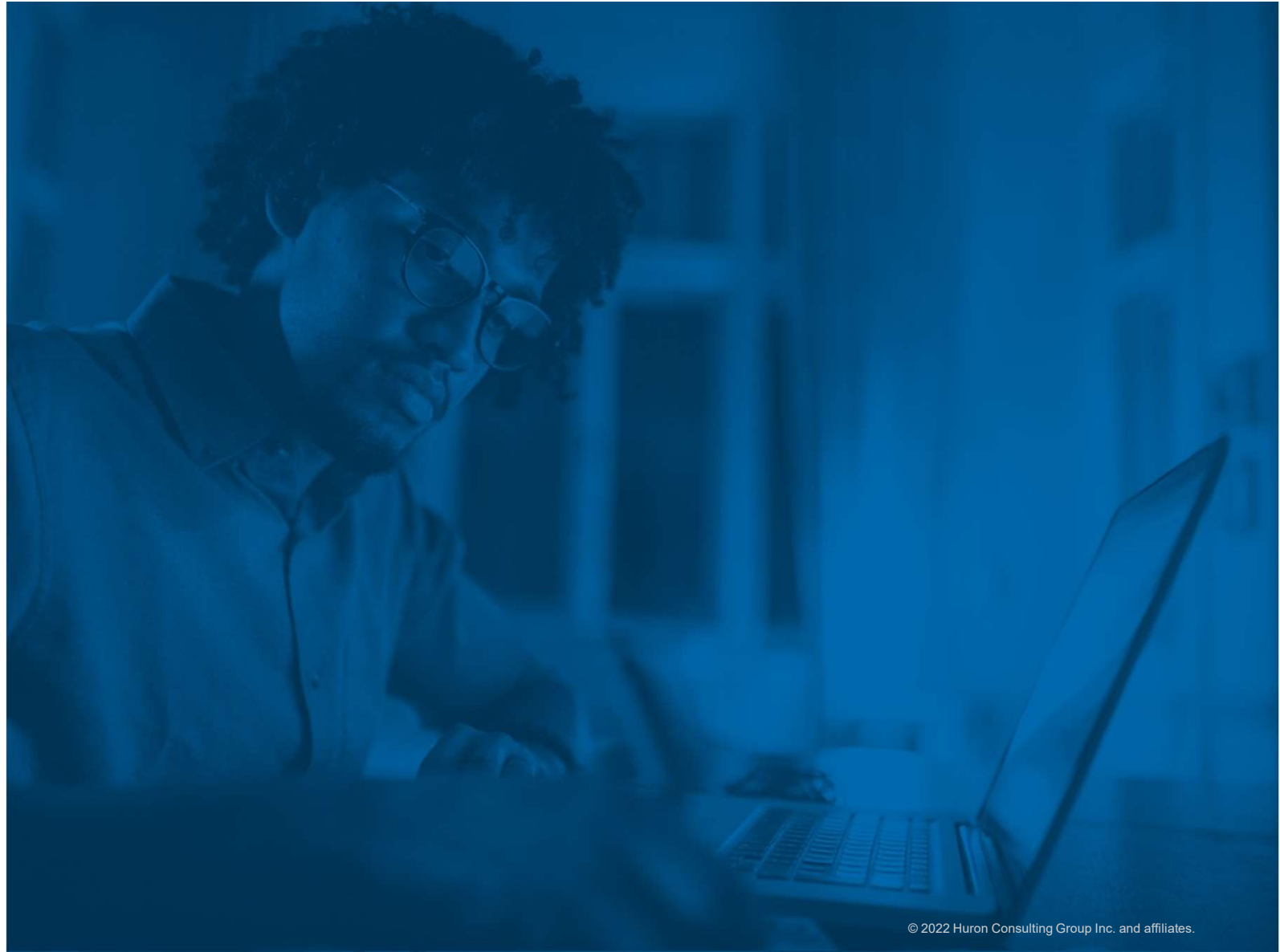

# Overview of Opportunity

USHE provides minimal central policy, oversight, or guidance related to compensation and classification to institutions. A compensation and classification study would yield informative to transformative results.

## Executive Summary

- High-level analysis of select institutions reveal **that the same positions can have varied role responsibilities** and compensation levels
  - There is **title proliferation** within institutions, creating challenges for HR units
- **The current structure carries risk** factors, such as litigation; nationally, the EEOC<sup>1</sup> has increased payouts and higher education has faced several high profile, million dollars lawsuits
- A compensation and classification study would **proactively seek to understand where improvements can be made to reduce risk and improve retention** and support establishing processes and structures for long-term success

## OFI Survey Results

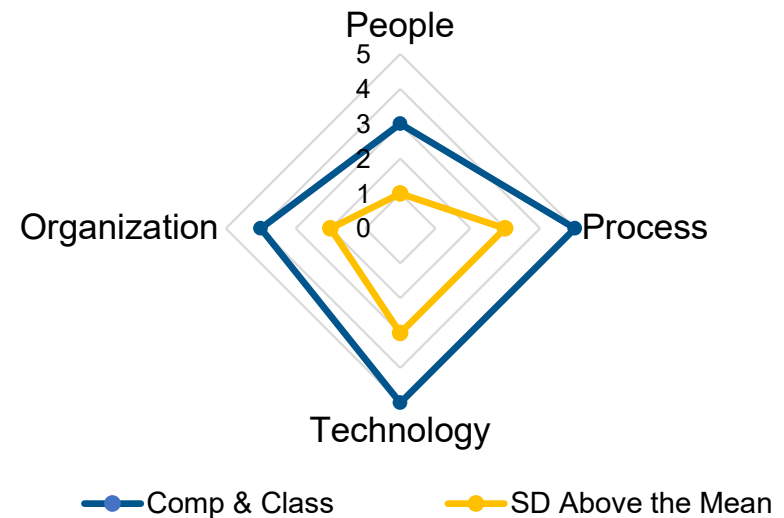

**OFI respondents reported “comp & class.” as the area with the most room for improvement.**

---

## Current-State Sample Analysis Disclaimers

The following sample analysis of USHE's current-state are high-level reviews meant to show potential areas for future considerations and assessment. Analysis mainly focuses on UU for consistency.

### **The following analysis is:**

- Meant to facilitate conversation regarding classification and compensation
- Based on actual census data
- Limited to select positions and analysis

### **The following analysis is not:**

- Comprehensive of a complete compensation and classification study
- Fully inclusive of institutional nuance
- Meant to represent recommendations



# Current-State Sample Analysis: Title Proliferation

Position title counts compared to employee IDs indicate title proliferation at USHE institutions. This can create challenges for oversight of position performance and systemwide HR initiatives.

Institution	Position Titles	Employee IDs
BTC	63	67
DTC	81	90
DSU	250	261
DXTC	17	20
MTC	60	93
OWTC	44	47
SLCC	436	678
Snow	96	115
SUU	346	391
SWTCH	26	27
TTC	21	26
UBTC	21	23
UU	1,680	4,309
USU	399	1,513

Institution	Position Titles	Employee IDs
UVU	1,031	1,247
WSU	574	778
<b>Total (In-Scope Only)</b>	<b>4,955</b>	<b>9,685</b>
<b>Total (All Positions)</b>	<b>10,095</b>	<b>50,382</b>

## Analysis Observations

- Surveyed employees show **high-levels of title proliferation**; for every ten employees there are **5.1** titles
- The results are supported by census wide data, where **for every ten employees there are two titles**, and the increase is mainly attributable to faculty and adjunct positions

Note(s): "In-Scope Only" titles refers to employees surveyed. All positions total refers to all positions included in the provided HR census information



# Current-State Sample Analysis: Position Pay

Misalignment between grade penetration and a normal distribution may demonstrate inequity as well as an additional need for pay program consistency.

UU Systems Administrators with Range Penetration of x%

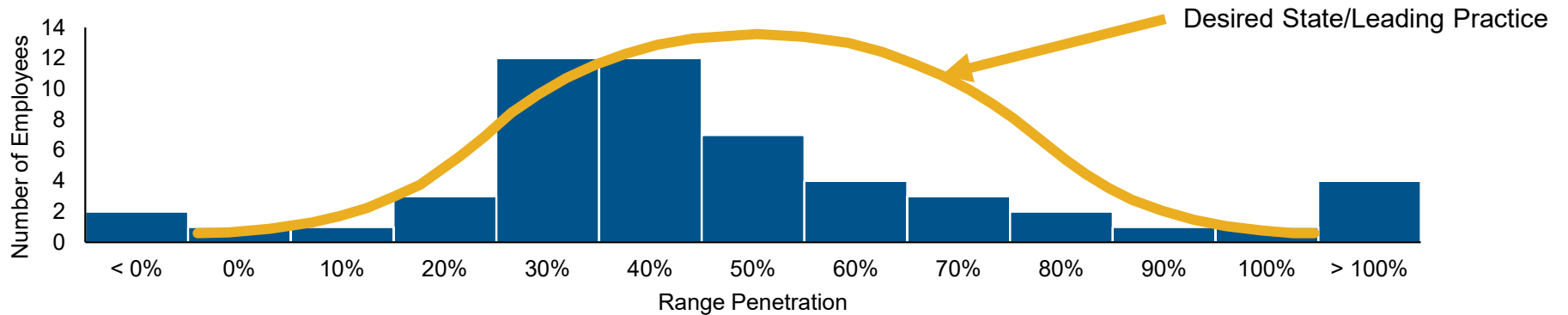

## Observations

- The grade penetration for Systems Administrators at UU **do not align** with leading practices
- Select employees are **outside of the policy range**, being either below 0% of the grade penetration or above 100%
- Additional analysis could show if UU should reassess the position band

## Methodology

- Range penetration is the **percent through the salary range at a given employees compensation**;
  - Example: an employee earning \$75K in a range of \$50K – \$100K has a penetration of 50%  $(\$75K - \$50K) / (\$100K - \$50K)$
- Systems Administrators assumed to have salary grade “F”<sup>1</sup>

Source(s): 1: Position grade per [HR job code table](#) and grade bands per [HR salary schedule](#)

# Current-State Sample Analysis: Role Fragmentation

Sr. Accountants at UU reported fragmented and inconsistent job responsibilities, which can create challenges related to career pathways, equitable pay, and hiring.

## Observations

- Position titles such as “Sr. Accountant” often have consistent responsibilities aligned with their functional area; however, **HAAS survey data from 33 UU Sr. Accountants shows that work is fragmented and inconsistent** with activity occurring in eleven different functional areas
- Job responsibilities have a wide range; **Sr. Accountants vary from highly specialized finance employees to generalists** spread across several functional areas
- The analysis is consistent with other position function distributions**, such as administrative assistants and academic advisors, suggesting potential issues with how job titles are assigned

## Sr. Accountant Comparison (UU)

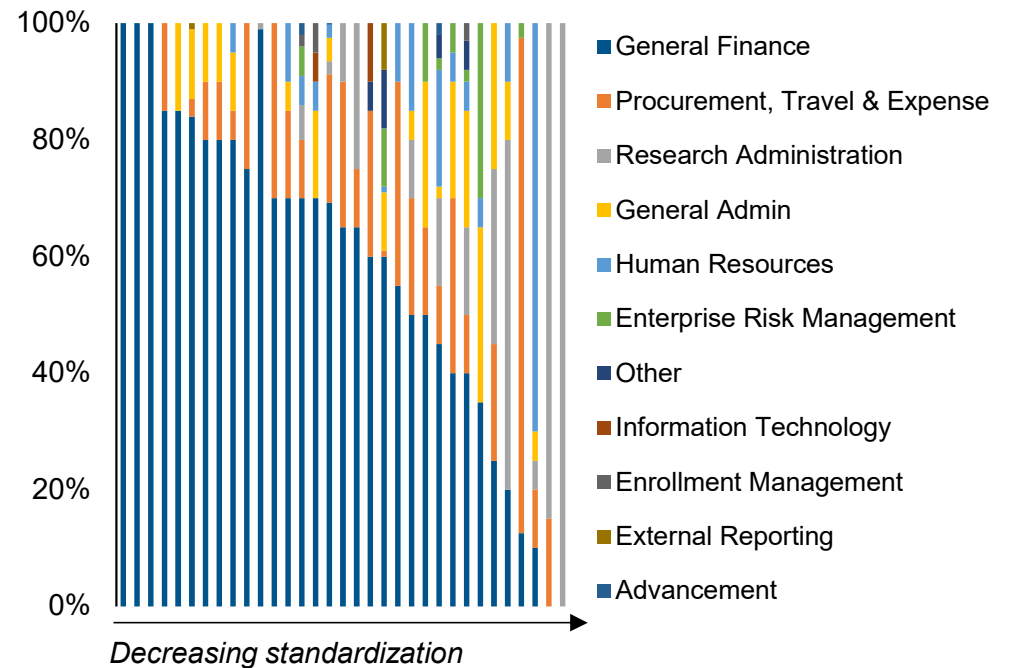

# Market Risk Trends

Inconsistent pay practices can be litigation risks. While related litigation has decreased, factors related to Utah, financial settlements, and higher education warrant an analysis of compensation practices.

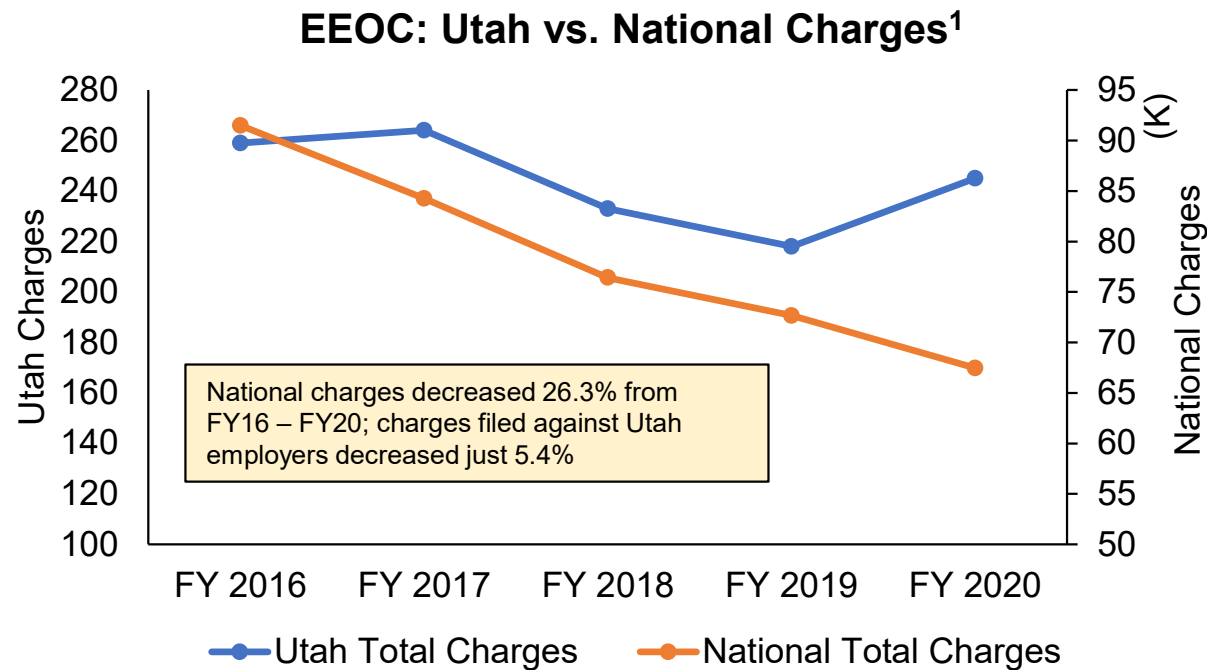

### Market Risk Trends

- National vs. State**  
 Utah has diverged from the national decrease, creating risk for Utah employers
- Increased Payouts**  
 Total recoveries increased from \$400M to \$605M over five years
- Higher Education**  
 Several high-profile lawsuits are in higher ed (see following business case)

Note(s): <sup>1</sup>A charge of discrimination is a signed statement asserting that an employer, union or labor organization engaged in employment discrimination

Source(s): <sup>1</sup>EEOC Data; <sup>2</sup>[Community college to pay employee \\$1.4M](#)

# Managing Risk Exposure

Based on national, state, and peer trends, USHE should expect some number of charges each year. The most effective way to mitigate this risk and cost is to proactively ensure that those charges are meritless.

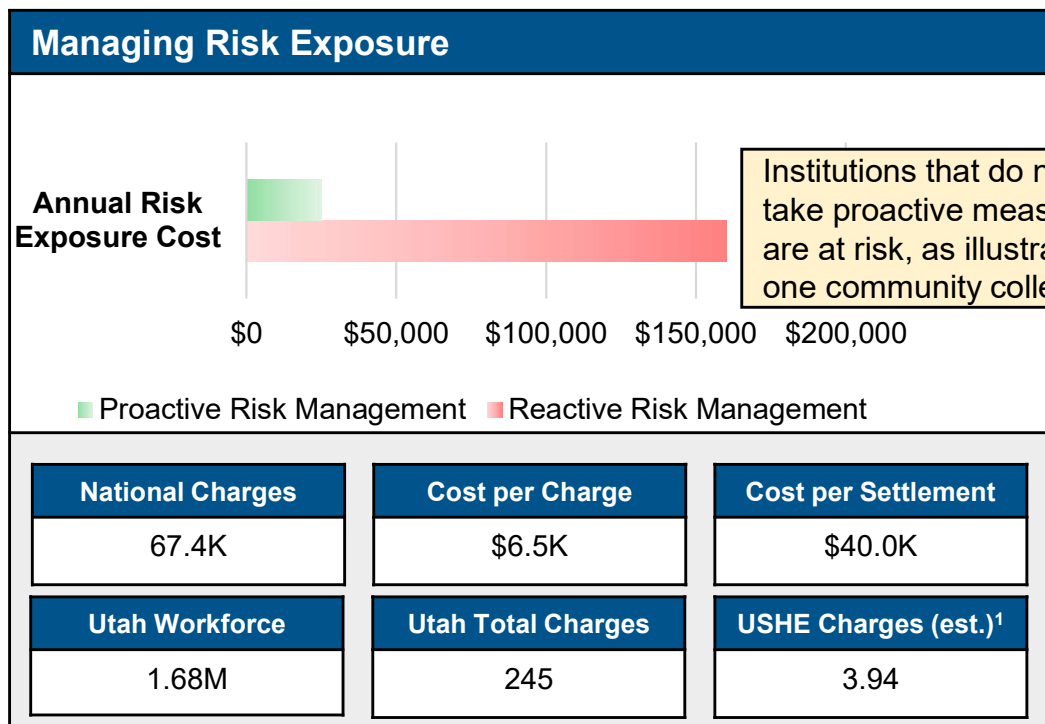

Note(s): <sup>1</sup>USHE estimate is based on applying average Utah charge rates to the number of USHE employees

Source(s): <sup>1</sup>[Des Moines Area Community College Case Study](#)





## Case Study:

### Des Moines Area Community College

- Des Moines Area Community College, a six-campus institution, was **sued for pay discrimination on the basis of gender** in 2020
- The lawsuit was brought forward by an applications support analyst who **alleged she had been paid “tens of thousands of dollars less”** than a male colleague **despite having the same title and responsibilities**
- In just ten days, **the jury sided with the plaintiff**, ordering the community college to pay over **\$220K in back pay, \$986K for emotional distress, plus interest, for a total of \$1.38M**
- Additionally, the institution incurred legal, reputational, and cultural costs from the case

# Peer Examples

Many systems conduct compensation and classification studies in order to better administer position management from the system office.

Seal / Logo	System	Initiative	Description and Benefits
	University of Tennessee System	System Compensation Project	<ul style="list-style-type: none"> <li>Improved hiring form to more accurately describe jobs, updated job families, created a statewide human resources team, currently studying gaps in pay and benefits on the updated position descriptions and revised job families</li> </ul>
	The Texas A&M System	The Texas A&M System-wide Pay Plan	<ul style="list-style-type: none"> <li>Standardized, systemwide pay plan classifications with associated job title, title code, salary pay grade, FLSA exemption status, and job family for positions</li> <li>Overseen at the System level</li> </ul>
	University System of Georgia	The BCAT Project	<ul style="list-style-type: none"> <li>Updated the centralized job classification and compensation structure</li> <li>Eliminated obsolete, mandatory job titles</li> <li>Supported consistent legal compliance and reporting across 34 institutions</li> <li>Created flexibility &amp; reduces shadow systems at the campus level</li> </ul>
	University of California	Career Tracks & Series Concepts	<ul style="list-style-type: none"> <li>Career Tracks enables UC to define job titles consistently within each location and across the university. It offers standardized job classifications, career paths, compensation that is aligned with the market, and professional development. UC plan to integrate all its institutions with career tracks</li> </ul>
	University of North Texas System	UNT World Staff Market Analysis	<ul style="list-style-type: none"> <li>Consolidated differing pay structures of four institutions into a single unified pay plan</li> <li>Created consistency in job analysis across institutions and streamlined pay grades</li> </ul>

---

# Compensation Study Transformative Goals

Depending on project scope, the goals of a compensation study are to create the information, processes, and organizational structures necessary to harmonize key factors for improving position management.

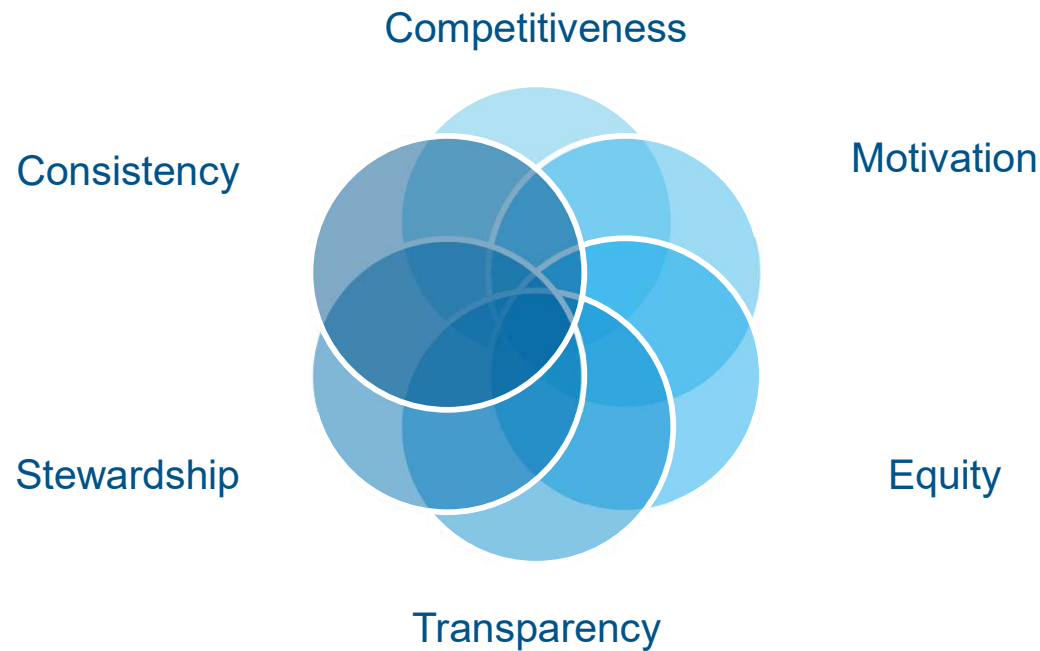

# Effective Employee Management and Turnover

Turnover is a way to measure the effectiveness of employee management. Initiatives such as a compensation and classification study reduce workplace turnover creating financial benefit.

## Why Employees Quit<sup>1</sup>

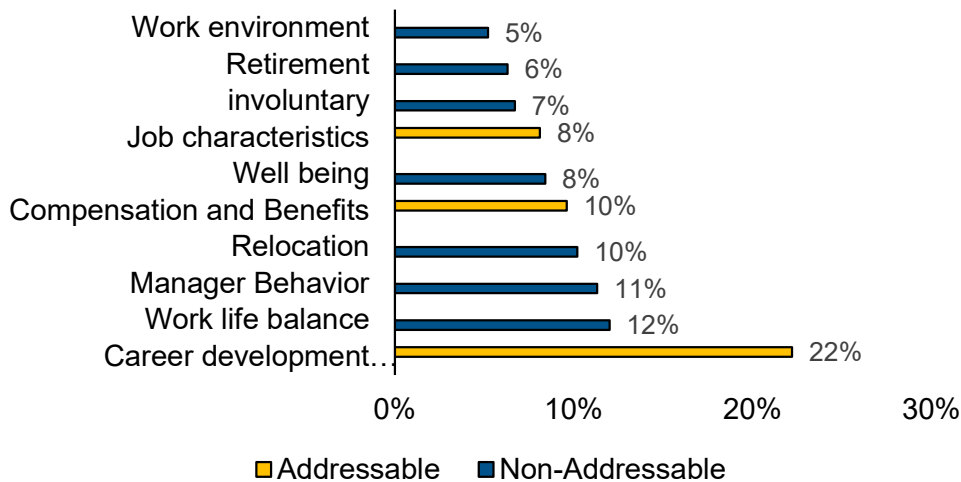

**40% of employee turnover is addressable through better position management.**

Source(s): <sup>1</sup>The Work Institute; <sup>2</sup>HEP inc.; <sup>3</sup>Internal Huron sources

## Estimated USHE Turnover Cost

**34%** annual turnover of higher ed administrators in 2021  
(up from 12% in 2018)<sup>2</sup>

**1.33 x Salary** conservative estimate for the cost of turnover<sup>3</sup>

**\$820M** Conservative estimate for USHE administrative position spend (HAAS data)





**\$131 – \$371M** Conservative estimate for annual cost of turnover at USHE institutions

# Scenario 1: Conduct a Study

Conducting a compensation and classification study across the System will give USHE institutions information about the current-state of compensation and leave implementation to each institution.

Scenario Description	Areas of Insight
----------------------	------------------

- The study would analyze compensation and classifications across the System, **evaluating internal campus structures, intra USHE comparisons, and market best-practices and benchmarks** for areas of risk and opportunities for optimization
- While the study would provide meaningful and useful information, **it may not generate positive change**, as there is no charge for institutions themselves to act
- Study is comparable to R811 3.3. Market Surveys, where **OCHE is charged with conducting market surveys for non-exempt personnel**; but there may be gaps in frequency or comprehensiveness

	Pay inequities and risk analysis
	Market competition
	Best-practice analysis
	Intra-USHE comparisons

Addressable Turnover Reduction	Savings (Low)	Savings (High)
0-1%	-	\$524K



# Scenario 2: Create Common Job Classification Structures

After completing the initial study, USHE can establish common job classification structures in order to address potential risks, inequities, and other areas of importance across the entire System.

Scenario Description	Creating Common Job Structures						
<ul style="list-style-type: none"> <li>Common job classification structures across a System <b>represent standardized job families, jobs, positions, pay grades and salary ranges</b></li> <li>Utilizing common job classification structures <b>streamlines employee transfers</b> across institutions, <b>establishes career pathways</b> within institutions, <b>facilitates institutional equity</b> analysis, supports consistent legal compliance and reporting, and other benefits</li> <li>Designing job classifications requires <b>extensive stakeholder engagement</b>, market analysis, and change management in order to succeed                             <ul style="list-style-type: none"> <li>For mandatory adoption of the classifications, USHE would need additional governance authority</li> </ul> </li> </ul>							
	<table border="1"> <thead> <tr> <th data-bbox="1058 1216 1524 1265">Addressable Turnover Reduction</th> <th data-bbox="1528 1216 1759 1265">Savings (Low)</th> <th data-bbox="1764 1216 1995 1265">Savings (High)</th> </tr> </thead> <tbody> <tr> <td data-bbox="1058 1268 1524 1317">1-3%</td> <td data-bbox="1528 1268 1759 1317">\$524K</td> <td data-bbox="1764 1268 1995 1317">\$1.6M</td> </tr> </tbody> </table>	Addressable Turnover Reduction	Savings (Low)	Savings (High)	1-3%	\$524K	\$1.6M
Addressable Turnover Reduction	Savings (Low)	Savings (High)					
1-3%	\$524K	\$1.6M					

# Scenario 3: Create System Office Governance

To maintain continuous improvement, USHE can create a unit within the System Office that is responsible for overseeing compensation and classification across the System.

Scenario Description	Example Governance Structure			
<ul style="list-style-type: none"> <li>After the completion of the study and development of standardize job classifications to support equity and career development, <b>establishing a unit with the System Office will support continuous improvement</b> and increase the likelihood of savings attainment                             <ul style="list-style-type: none"> <li>The establishment of such a unit may require governance revisions</li> </ul> </li> <li>The unit would be <b>responsible for monitoring comp and class, updating structures as needed, and supporting institutions</b> leverage the new system</li> <li>These <b>system administered units are industry best-practice</b>, with several systems using similar structures</li> </ul>	<pre> graph TD     A[Institutions] --- B[Inst. HR]     C[USHE HR] -.- B                     </pre>			
<b>Roles and Responsibilities</b>				
<b>USHE HR:</b> Oversees systemwide compensation and classification initiatives and supports compliance with institutions				
<b>Institutions:</b> Oversee campus HR and coordinate with USHE as needed				
<b>Institutional HR:</b> Direct reporting to respective institution with dotted line reporting to USHE HR for compensation and classification areas				
<b>Addressable Turnover Reduction</b>			<b>Savings (Low)</b>	<b>Savings (High)</b>
3-5%			\$1.6M	\$2.6M

# Scenario Summary

Below presents the summary range from least to most transformational. Each scenario is builds on the previous one.



## Scenario 1: Conduct a Study

Employee Impact	Risk Prevention	Cost Impact
Low	Moderate	\$0-524K

## Scenario 2: Create Common Job Classification Structures

Employee Impact	Risk Prevention	Cost Impact
High	Moderate	\$524K-1.6M

## Scenario 3: Create System Office Governance

Employee Impact	Risk Prevention	Cost Impact
High	High	\$1.6-2.6M

# Implementation Approach

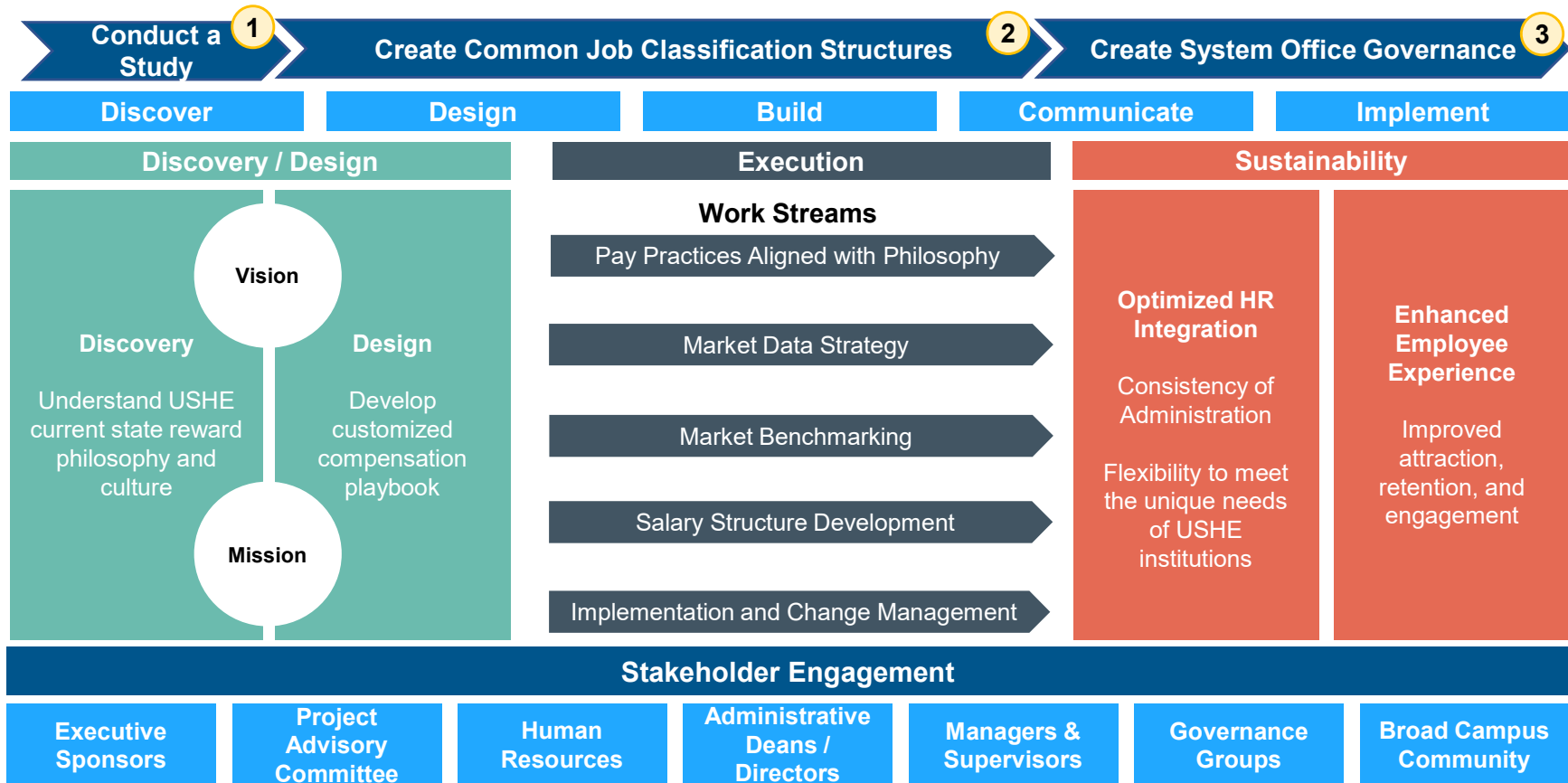

# 7

---

## Shared Benefits Administration

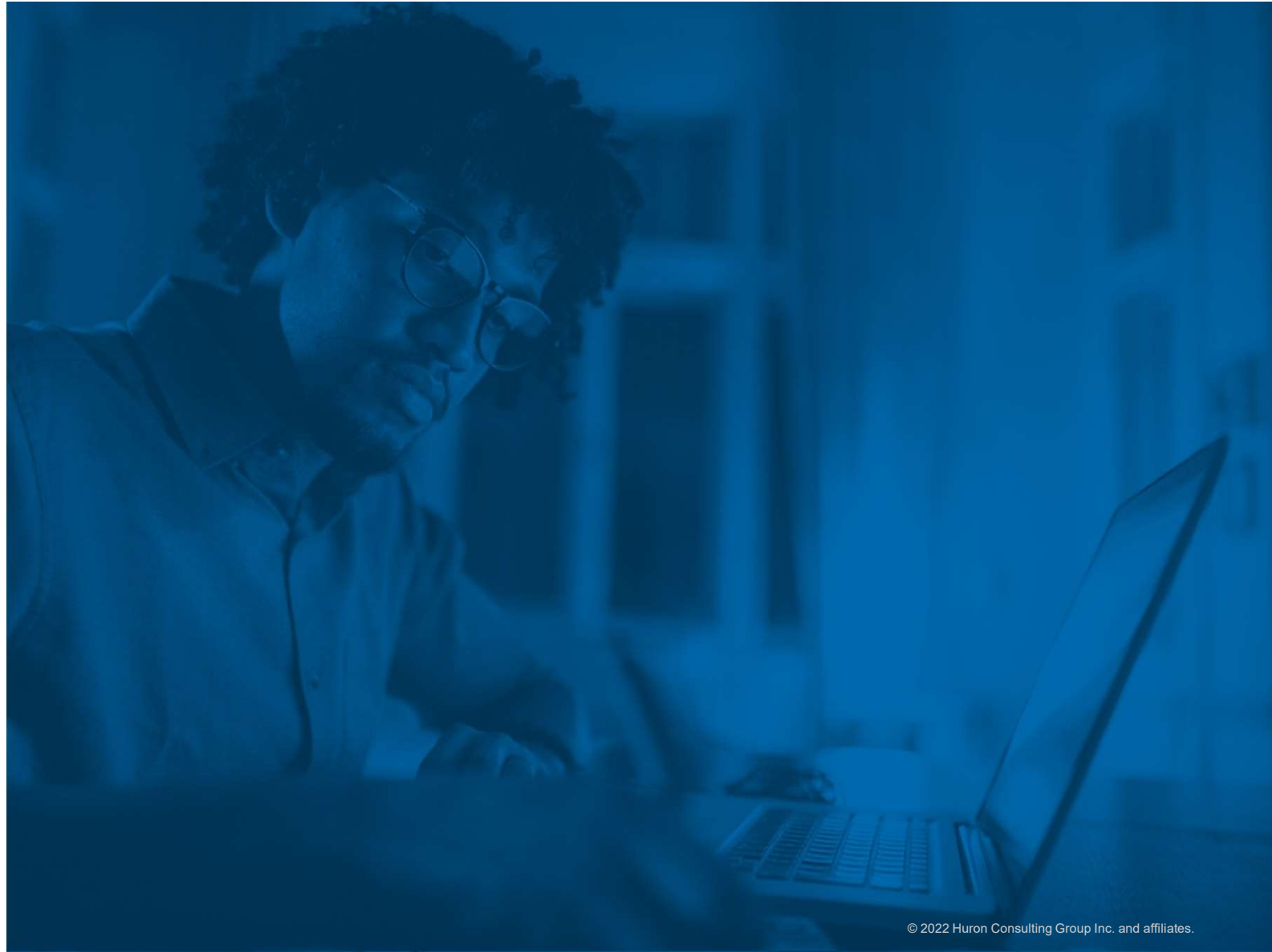

# Overview of Opportunity

Establishing shared benefits and shared benefits administration leverages USHE's size to improve bargaining power and reduces redundant administrative work at the institution level.

## Benefits Overview

- Each institution is currently responsible for their benefits operations, which has created **several different operating models** and limits the advantages and abilities to collectively negotiate and support benefits administration
- USHE's current governance structure:
  - Does allow for **shared administrative support** of benefits
  - Does **not allow for systemwide shared benefits**
- The diverse range of current benefit administration and plan makes **the alignment of benefit plans, processes, and policies a prerequisite for realizing savings** from shared services

## Key Metrics<sup>1</sup>

**\$451.3M annual USHE spend on employee benefits**

**70% the increase in benefits spend from 2012**

**\$1.2M annual spend on benefits administration**

Source(s): <sup>1</sup>Data from USHE Data resources and HAAS data

# Benefit Administration Tasks and Responsibilities

Benefit administration encompasses processing, customer support, and strategic support that facilitate enrollment and offering of benefit packages at an optimal price point.

<b>Processing</b>	Performing benefits related processing	Documenting administrative procedures for benefits processes	Processing claims and invoices
<b>Customer Support</b>	Supporting employee enrollment in benefits	Employee education on benefits related needs	
<b>Strategic Expertise</b>	Advising on institutional benefit plan selections	Working with brokers and negotiating optimal arrangements	Support choosing best benefit provider and options for institution
	Ensuring regulatory compliance		

# Trends in Benefit Administration

Employees seek nuanced services personalized to their needs, while also seeking lower premiums and deductibles. These shifts, combined with increased regulatory complexity, are challenges for employers.

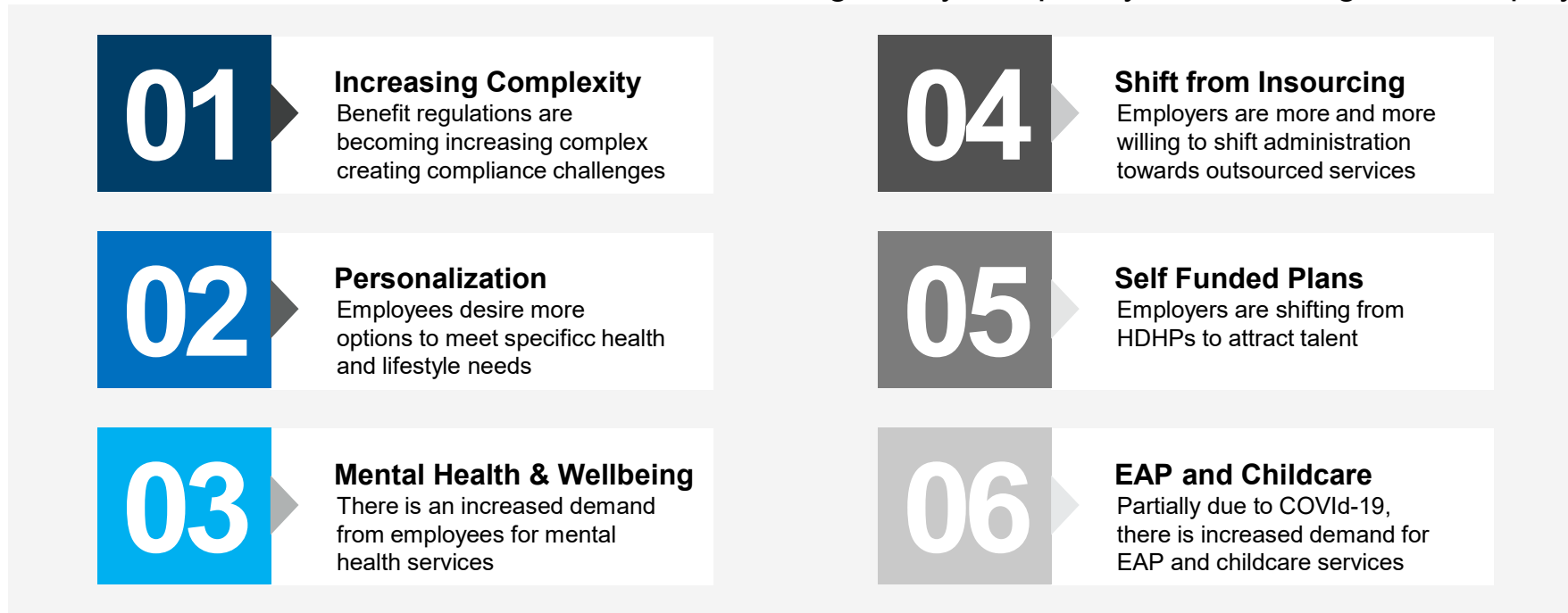





Source(s): <sup>1</sup>[ADP Benefits Study](#); <sup>2</sup>[SHRM Trends in Benefit Administration](#)



# Higher Education Benefits Administration

Many higher education state systems centrally manage and administer benefits to their constituent institutions.

Seal / Logo	System Name	System Provided Benefits
	The Texas A&M University System	<ul style="list-style-type: none"> <li>The system office offers health and welfare insurance plans, optional retirement savings opportunities, negotiates contracts with carriers for insurance, and provides employee customer service</li> </ul>
	The University System of Georgia	<ul style="list-style-type: none"> <li>The system offers and administers a comprehensive suit of benefits including retirement plans, group health insurance, group life insurance, disability insurance, and more</li> </ul>
	The University of Maine System	<ul style="list-style-type: none"> <li>Maine offers a centralized, one-stop resource for benefits enrollment, information and assistance; the system is responsible for the administration of employee benefits</li> </ul>
	The University of Texas System	<ul style="list-style-type: none"> <li>UTS centrally administers and provides medical insurance with prescription drug coverage, dental, vision, life, AD&amp;D, disability insurance, wellness resources, retirement plans, and FSA</li> </ul>
	The University System of Maryland	<ul style="list-style-type: none"> <li>Maryland provides health benefits, prescription drug coverage, retirement plans, life insurance, long-term disability insurance, EAP and wellness resources</li> </ul>

# Benefit Administration: USHE Overview

In contrast with other state systems, each USHE institution chooses their own providers and is responsible for the administrative support. Governance is a key enabler for opportunities.



## Medical Benefits Overview:

- USHE institutions use several providers and a mix of self insured and fully insured options
- PEHP is a state option that covers most benefit areas

## Medical Benefits Examples:

- Health coverage, prescription drug coverage, COBRA, etc.



## Retirement Benefits:

- USHE institutions each use their own retirement plan providers
- Legacy Utah employees are eligible for the URS pension; new employees are not allowed to participate

## Retirement Benefit Examples:

- Pensions, 401(a), 401(k), 403(b), etc.



## Supplemental Benefits:

- Supplemental benefits cover a range of benefit areas
- The institutional impact is lower and is an opportunity for incremental USHE involvement

## Supplemental Benefit Examples:

- Vision, childcare, life insurance, EAP, etc.



## Administration & Governance :

- Each institution oversees its own plans and administration
- In the current-state, USHE is not able to offer shared benefits
- USHE can provide administration, however, without plan alignment, central administration may be ineffective

# Benefit Expenditure Trends

USHE spend on benefits has steadily increased while remaining a constant percent of total expenditure, indicating that USHE can better leverage its increasing scale to reduce benefit costs.

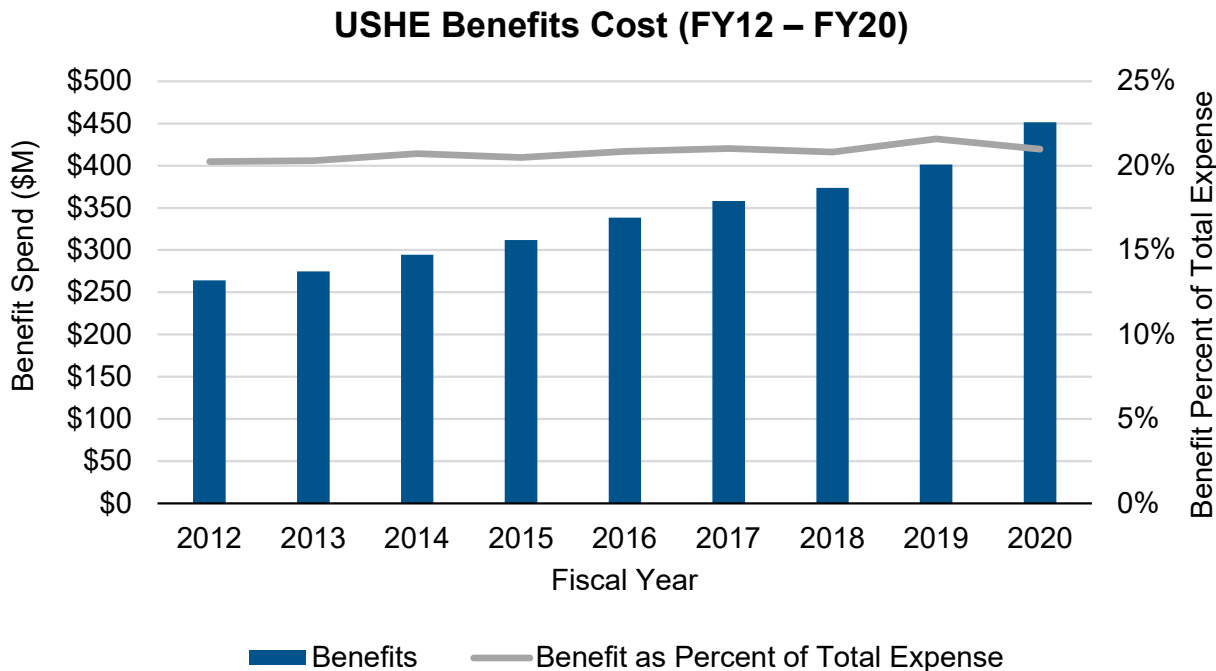

Source(s): [USHE Data Resources](#)

### Findings

- Benefit expenditures **have increased by 70%** from FY12 to FY20
- **Benefits do not represent a growing share of expenses**, maintaining a range of 20% – 21% of total expenditures
- USHE can reduce and **contain benefit costs by working as a collective** to take advantage of the increase in USHE institution scale

# USHE Stakeholder Considerations

When asked about the need to maintain in-house benefit administration, large and midsized organizations report different needs, an important consideration for USHE’s diverse constituency.

**Reasons for Maintaining In-House Benefits Administration**

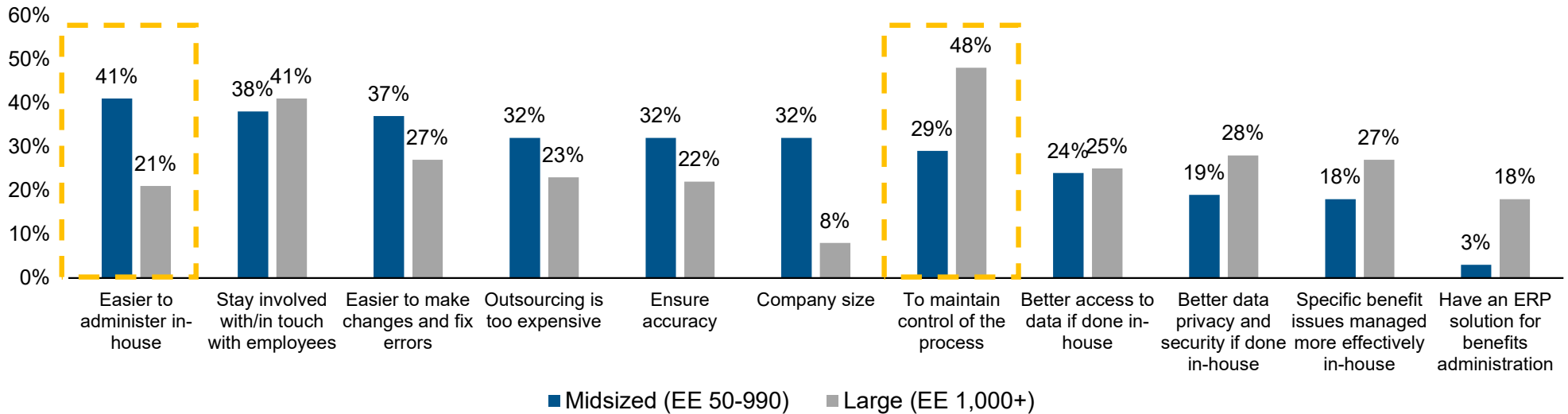

**Large organizations report ease of administration as being a factor at half the rate as midsized organizations, indicating potential advantages of scale for USHE.**

Source(s): [ADP benefits survey](#)

# Benefit Administration: Administrative Support

USHE spends 13.9 FTE and \$1.2M on support benefit administration per year. Through centralized support and specialization, this area could see efficiencies through centralized administration.

## Benefit Administration Admin Support

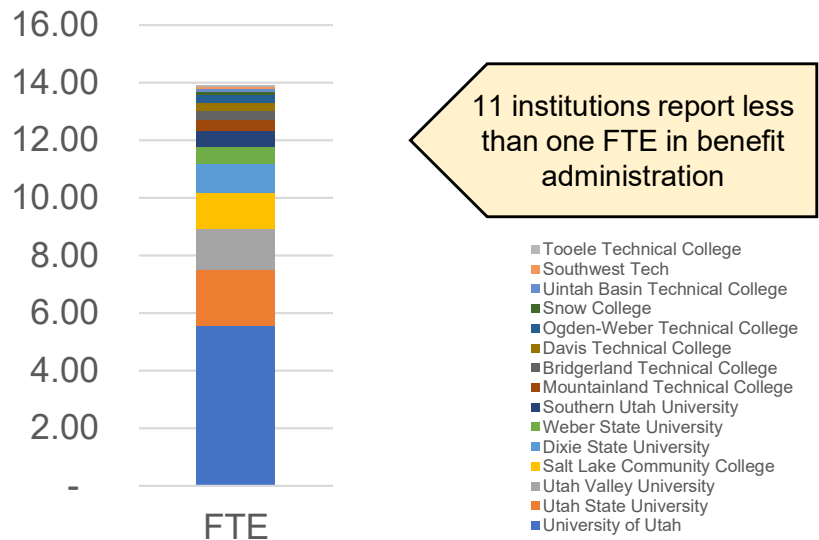

**Low support creates compliance risks, which can be reduced through routine audits.**

## Benefit Admin Cost Per FTE

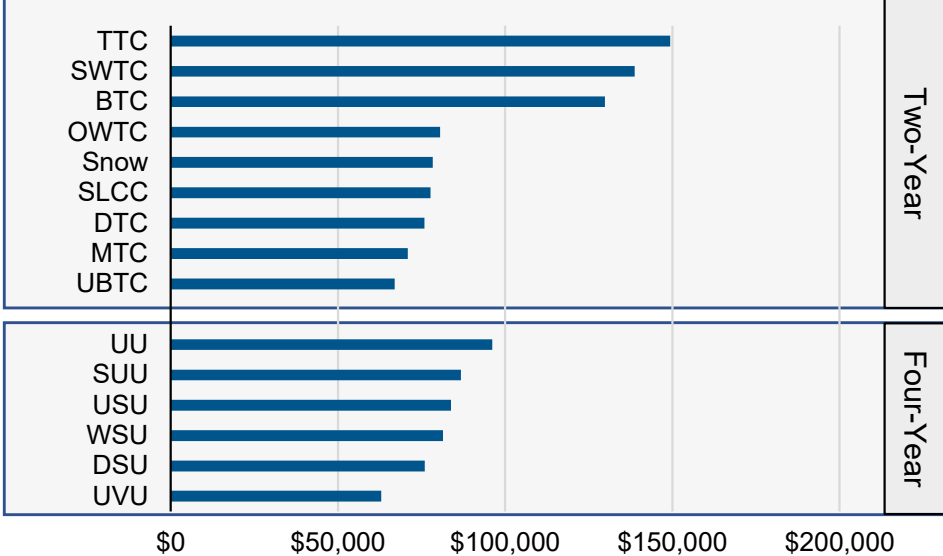

**Smaller institutions generally have higher costs per FTE, a sign of operational inefficiency.**

# Shared Benefits Change Considerations

USHE should prioritize areas with low barriers for implementation and develop governance structures needed to address operational inefficiencies with benefits and benefits administration.

## Governance Barriers

- USHE does not have a governance structure that allows it to provide shared benefits
- USHE does not have an enforcement mechanism to require participation in shared services

## Operational Inefficiencies

- Redundant retirement plan providers
- Ineffective leveraging of scale
- Multiple plan administrators
- Risks from low FTE support institutions

## Lack of Burning Platform

- Stakeholders were generally positive about their benefit offerings and their administration
- Benefit expenses are not increasing as a percent of operating expenditures

## Areas of Interest

- Retirement plan alignment
- Customer service
- Plan design support
- Supplemental benefit alignment
- Collective RFP's and brokers
- Sustainable, long-term governance

“We like our benefits, and it would be unpopular to get everyone on the same plan. There may be opportunity to use USHE’s scale with supplementary benefits.”

# Scenario Framework

The value from each scenario for benefit administration opportunities is dependent on the level of plan alignment across the System. Without alignment, financial and operational impacts may be minimal.

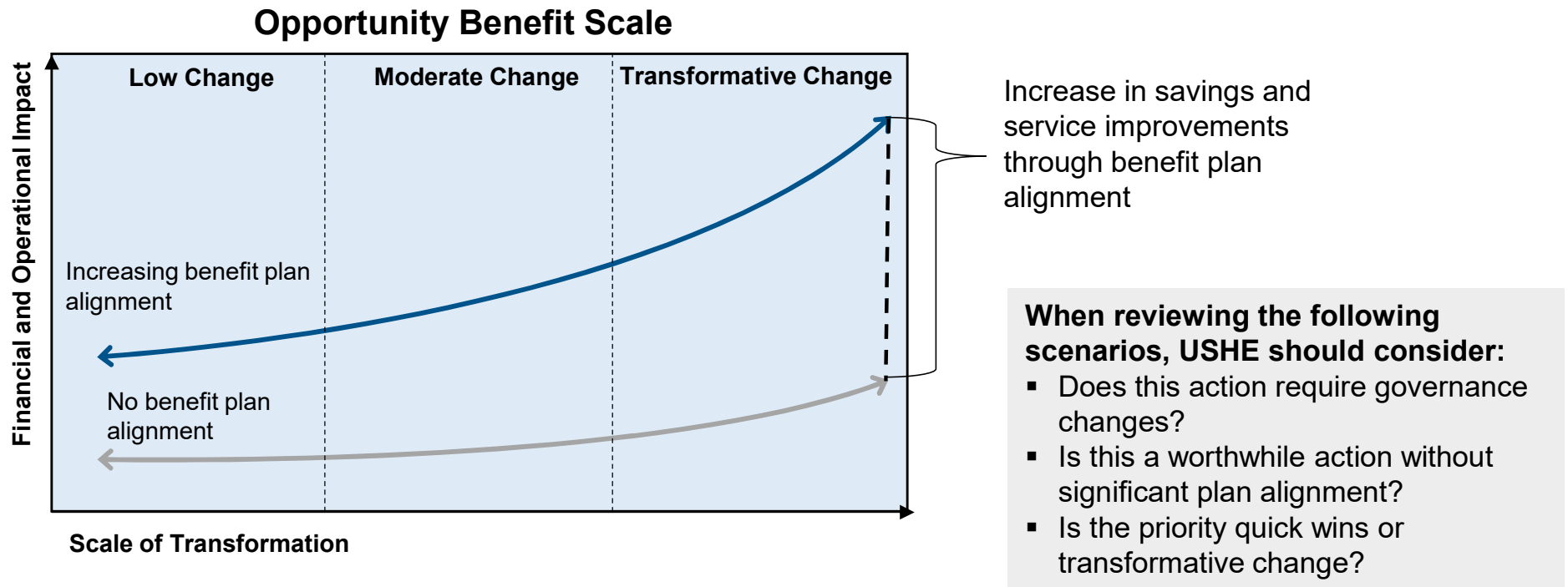

# Scenario 1: CoE Design and Administration

Establishing a center of expertise that supports benefit plan design and administration for the institutions would increase each institution's ability to make optimal choices on plan selection.

## CoE Description

- Provide **expertise** related to benefits for institutions
- Interface with benefit providers, acting as **SMEs** for the institutions
- Receive strategic goals from USHE and **perform analysis** to support the development of strategic plans related to benefits

## Roles and Responsibilities

**USHE HR:** Oversees the center of expertise, establishes goals

**Center of Expertise:** Serve as central strategic support hub

**Inst. Benefits Administer:** Direct support inquiries to CoE

**Benefit Providers:** Interface with institutions and CoE

## CoE Organizational Structure

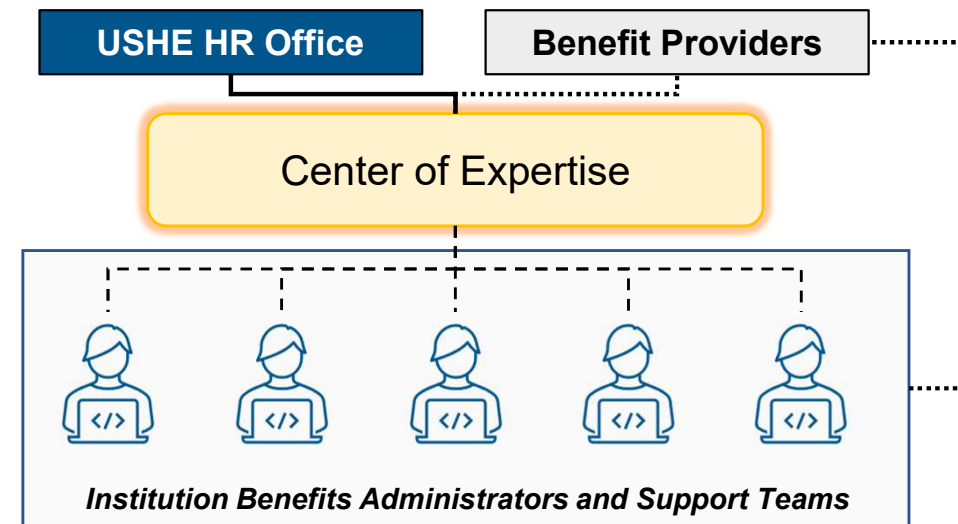



# Scenario 2: T1 Call Support Center

Creating a call support center to manage employee questions on benefits could reduce the \$1.2M currently spent on benefits administration.

## Call Support Center Description

- Center receives and **answers general benefits related questions**, routing more complex questions to the CoE
- Center **staffing is highly dependent on if there is process, policy, and plan alignment**; without alignment center staffing costs may exceed current expenditure

### Roles and Responsibilities

**USHE HR:** Oversees the center of expertise

**Call Support Center Staff:** Receive, answer, and route inquiries

**Center of Expertise:** Support more complex questions

**USHE Institution Employees:** Direct questions to the support center

## Support Center Organization Structure

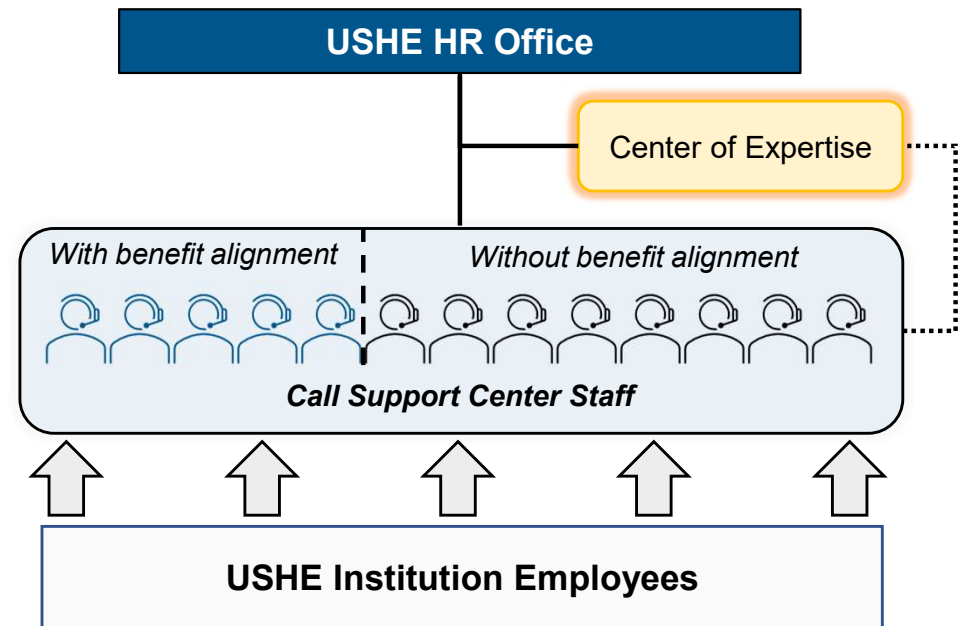

# Scenario 3: Benefit Plan Alignment and Admin Support

Working as a collective entity would increase bargaining power for reduced costs when entering into benefits agreement, eliminate redundant administration, and improve benefit offerings for employees.

## Benefit Plan Alignment Overview

- Aligning on benefit plans and providing the administration as a shared service is a **cost saving** opportunity
- USHE would need to **change its governance structure** in order to administer shared benefits
  - Opportunities under current governance are **limited to group RFPs, assessing broker options**, and other small in scale options
- As new employees can no longer participate in the URS pension program, **USHE should consider streamlining institutional retirement plans**
- **PEHP**, the Utah health and benefits provider, offers services that **cover most major benefit areas**
  - PEHP is fully funded, which may drive higher costs at the institutional level

## Selecting Shared Benefits

### Alignment Implementation Difficulty

➔	
Supplementary & Moderate	Transformative
<ul style="list-style-type: none"> <li>▪ Childcare</li> <li>▪ Vision</li> <li>▪ Life insurance</li> <li>▪ ADD insurance</li> <li>▪ Disability (short- and long-term)</li> </ul>	<ul style="list-style-type: none"> <li>▪ Medical benefits</li> <li>▪ Prescription drug coverage</li> <li>▪ Dental insurance</li> <li>▪ Retirement plans</li> </ul>
<p>Supplementary benefits are easier to achieve with often smaller benefits, fiscally and operationally. USHE should target areas of alignment based on actuarial analysis and work with institutions to transition them to a shared service offering.</p>	

# Shared Benefits Next Steps and Risk Management

Key next steps are deciding the goals for USHE benefits changes and performing or hiring a service to conduct an actuarial analysis.

Phase	Benefits Assessment		Future State Design		Implementation	
Timeline	Months 0 - 4		Months 4 - 10		Months 10 - 22	
Key Activities	<p>Conduct actuarial analysis on benefit alignment</p> <p>Identify specific benefit elements for transition to USHE</p> <p>Set change goals and discuss analysis outputs with institutions</p>	<p>Finalize which benefits are being transitioned</p> <p>Forecast administration support staffing needs and perform org design</p> <p>Perform process mapping</p>	<p>Hire and onboard System benefits team</p> <p>Work with providers to discuss any changes in processes or coverages</p> <p>Communicate change plan to institutions</p> <p>Make governance changes as needed</p>	<p><b>Governance:</b> The current governance structure limits USHE's ability to effectively administer and provide shared benefits</p>	<p><b>Change management:</b> Institutions may want to retain control over their benefit plans and building consensus is key to successful change</p>	<p><b>Process and policy alignment:</b> Processes and policies need to be consolidated and streamlined to the fullest extent possible to optimize efficiencies</p>
Key Risks						

# 8

---

## Employment Law

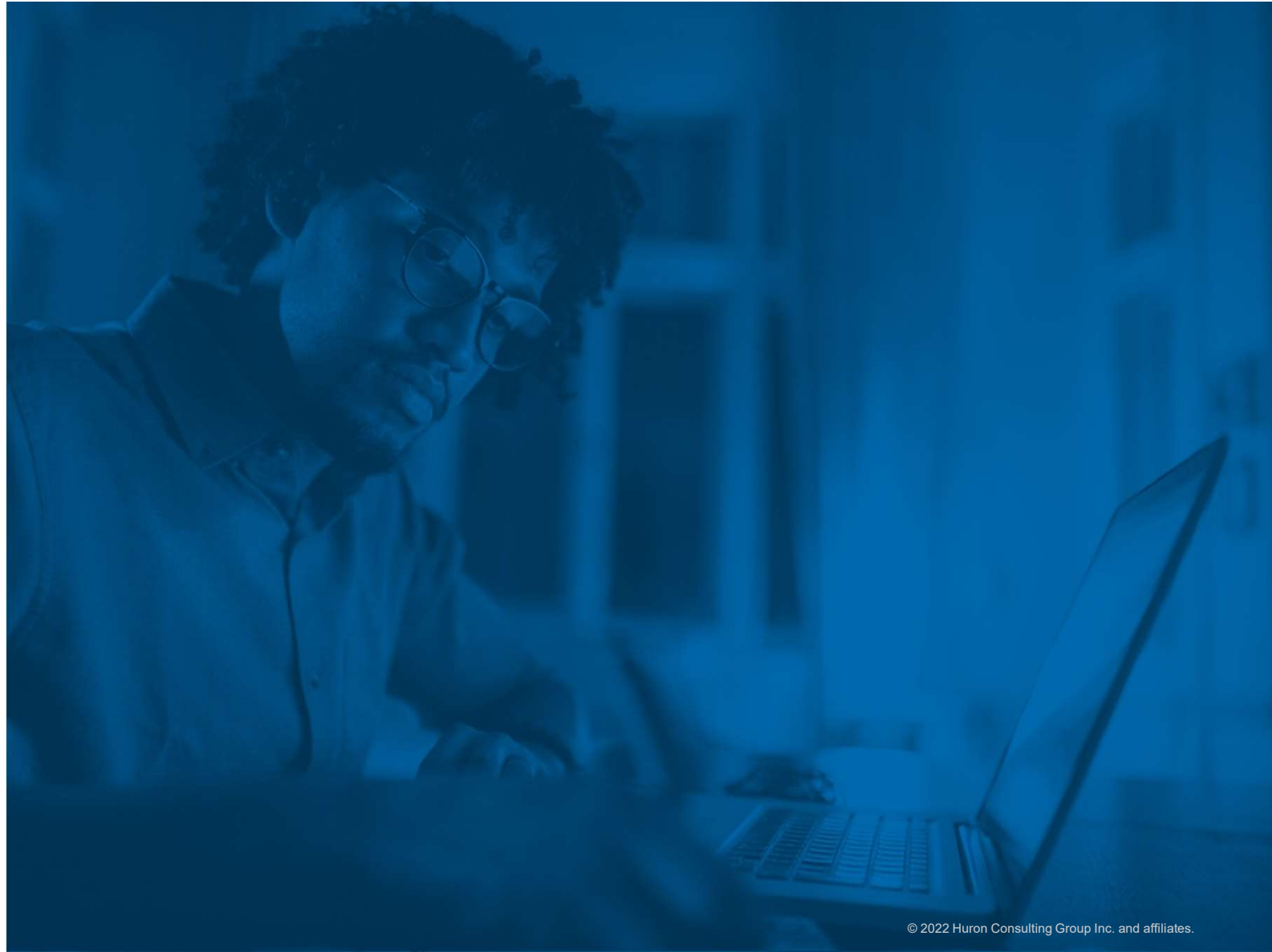

# Overview of Opportunity

USHE can improve service delivery and ensure employment law compliance by creating a center of expertise to support employee relations efforts.

- USHE dedicates **25.8 FTE** and invests **\$2.93M** in employee relations activity
- The majority of employee relations activity is distributed, which points to **unstandardized policies and practices**
  - Currently, there are separate employment law policies amongst the degree-granting institutions and the technical colleges<sup>1</sup>
- Conversations with stakeholders revealed that there is **a lack of systemwide resources** for employee relations, which has led to **compliance risks and issues**
- Developing a center of expertise to act as an external resource for employee relations will provide institutions with the necessary support to ensure **employment law compliance** across the System

Employee Relations Distribution

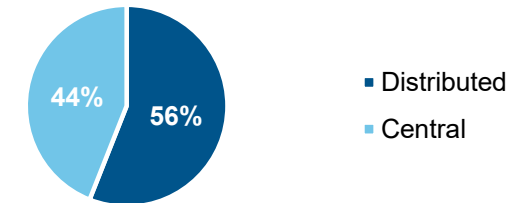

Employee Relations to Total HR Expenses

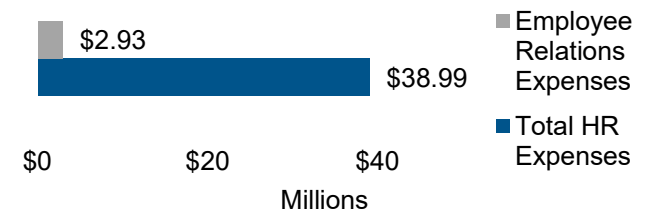

**The following slides provide an overview of employee relations, current USHE standings, industry best practices, and modeling of potential future state scenarios.**

Source: [1USHE website](#)

---

# Employment Law Overview

Employment law regulates the relationship, responsibilities, and rights amongst employers and employees and is a key component of employee relations.

*The following terms are essential when considering employment law and the role it plays in employee relations:*

- **Employment contract:** A formal agreement between two parties that outlines the terms and conditions of employment to which the parties agree
- **Employee protection:** Whistleblower protections for employees who report violations of the law by their employers, including any sort of harassment, are mandated in the workplace
- **Wages and hours:** There are standards in place that outline the requirements for what employers must pay for wages and overtime pay
- **Workplace safety and health:** Employers have a duty to provide their employees with work and a workplace free from recognized, serious hazards
- **Employee benefit security:** There are regulations in place for employers who offer pension or welfare benefit plans for their employees
- **Legal counsel:** Institutions will often have an office or individual who provides legal services and advice regarding the institution's legal matters

# Importance of Employment Law

Failing to stay within compliance for employment law can lead to serious monetary and legal risks that can impact an institution's overall wellbeing.

## Employment Law Risks



**Civil Lawsuit:** Employees and former employees can file a lawsuit if they think an organization is out of compliance



**Audit:** Suspicion about non-compliance can lead employees to file a claim with the government that will trigger an audit



**Fines:** Violations of employment laws, including wages, discrimination, and federally mandated leave can lead to expensive fines

## Potential Consequences



**Financial Costs:** Breaking employment laws can cost institutions millions of dollars from legal fees, fines, and compensatory damages



**Time:** Determining the appropriate solution for an employment law violation can be time-consuming; on average a civil lawsuit takes around 318 days



**Capacity:** Solving employment law violations requires institutions to provide appropriate resources, which can lead to a decrease in capacity



**Reputation:** A history of non-compliance projects an image that employee relations is not taken seriously, which impacts employee recruitment and retention

# Case Study: University of Denver

The University of Denver was sued by the U.S. Equal Employment Opportunity Commission for gender-based pay discrimination, which cost the institution \$2.7M.

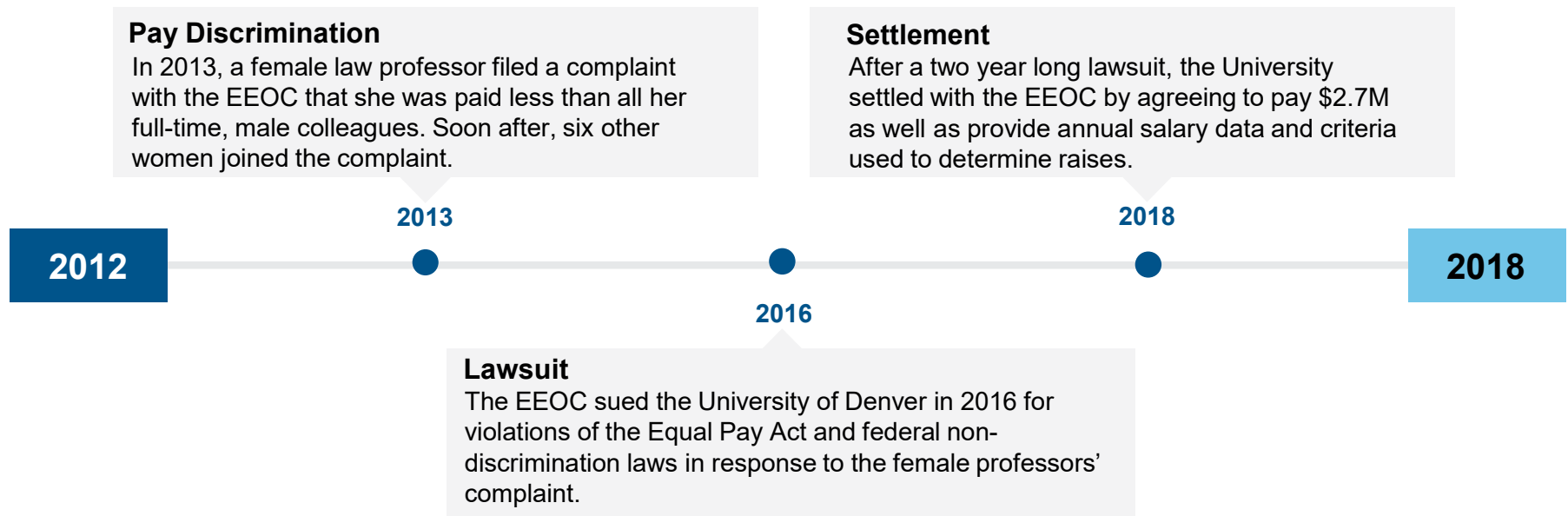

**In failing to abide by anti-discrimination laws, the University of Denver not only allowed a discriminatory institutional culture, but also wasted expensive time and monetary resources.**



# USHE Employee Relations Support

Currently, USHE is providing little support to employee relations, with many of the institutions dedicating less than 1 FTE to the area.

## Stakeholder Input

“We do what we can to stay in compliance, but we don’t have anyone dedicated to employee relations.”

“We just don’t have enough people to deal with employee-related relations.”

**Stakeholder input and HAAS data shows that USHE lacks adequate employee relations support. This can lead to potential acts of non-compliance with financial and cultural consequences.**

## Employee Relations FTE by Institution

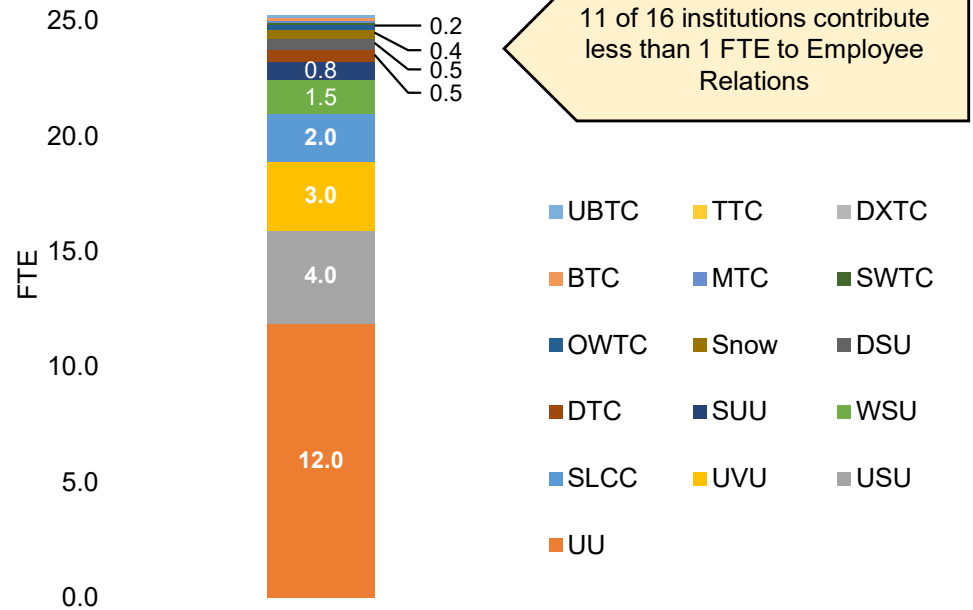

# USHE Employee Relations Expertise

The majority of USHE institutions rely on HR generalists for employee relations work, which depicts expertise and resource gaps across the System.

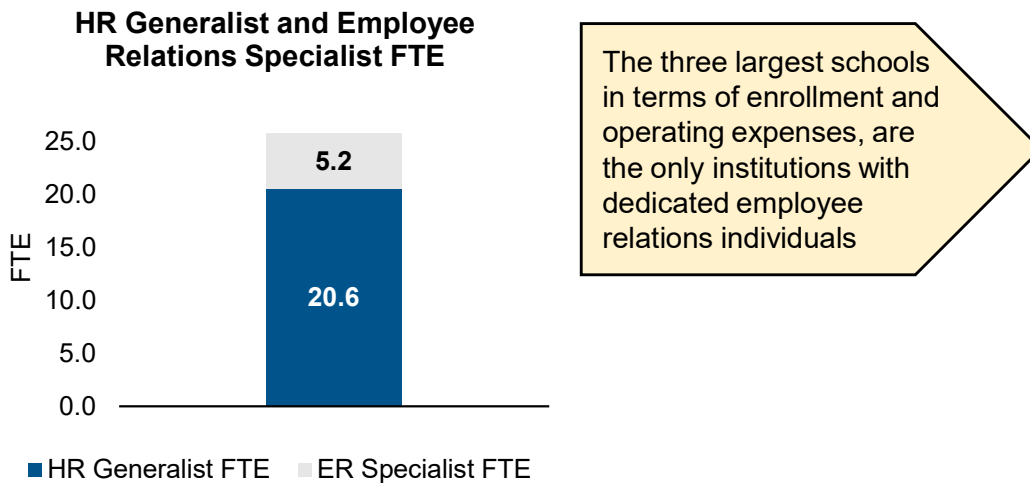

Institution Name	HR Generalist FTE	Employee Relations Specialist FTE
UU	9.0	3.3
USU	3.3	0.9
UVU	2.2	1
SLCC	1.9	0
WSU	1.5	0
SUU	0.8	0
DSU	0.5	0
Snow	0.4	0
DTC	0.5	0
OWTC	0.2	0
MTC	0.1	0
BTC	0.1	0
UBTC	0.0	0
DXTC	0.1	0
SWTC	0.1	0
TTC	0.0	0

**Without adequate and dedicated resources for employee relations activity, institutions risk employment law non-compliance due to a lack of proper oversight and support.**

Note: Employee Relations Specialists determined if individual spends more than 0.75 FTE in the area

# USHE Legal Counsel

USHE policy states that each institution may have an office of legal counsel as a precautionary measure for legal matters, yet the majority of institutions do not have such an office.

*“...the President of each institution with the approval of the institution’s Board of Trustees may create an office of legal counsel to provide legal advice to the institution’s administration and to coordinate legal affairs within the institution.” Policy R135<sup>1</sup>*

Institutional Legal Counsel Overview

UU	USU	UVU
WSU	DSU	SLCC
		SUU

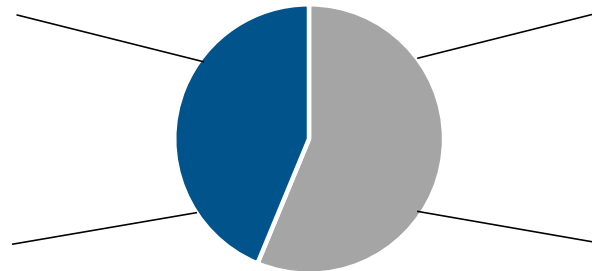

Snow	DXTC	OWTC
DTC	SWTC	MTC
BTC	TTC	UBTC







■ With Legal Counsel ■ Without Legal Counsel

**The institutions that do not have in-house legal counsel put themselves at risk for costly and time-consuming solutions to employment law violations.**

Source: <sup>1</sup><https://ushe.edu/ushe-policies/policyr135/>  
 Note: Legal counsel data from institutional census data

## Examples in Higher Education

Multiple institutions and state systems have implemented a more focused employee relations service line to mitigate risk, ensure compliance, and avoid potential costs.

Seal	Institution Name	Services Description
	University of Chicago	Employee Relations partners with unit-level HR to provide guidance in policy, contract administration, employment law compliance, and more.
	University System of Wisconsin	The System implemented a center of expertise that provides HR leadership, policy development, guidance, and functional expertise across the UW System.
	The Pennsylvania State University	A shared service center supports campus HR Business Partners in risk assessment, policy interpretation, investigation support, and liaison to counsel.
	Connecticut State Colleges and Universities	CSCU developed a center of excellence centered on labor relations including grievances, investigations, policies, and compliance.
	Ohio State University	A service center was developed at each campus which provides support for inquiries related to employee relations.
	University System of Georgia	The shared services center partners with the University System Office and USG institutions to operationalize policy, compliance, and legislation.

# Connecticut State Colleges and Universities CoE



CSCU provides best practice labor relations support through a center of excellence that oversees internal relations, such as investigations. The investigation process is illustrated below.

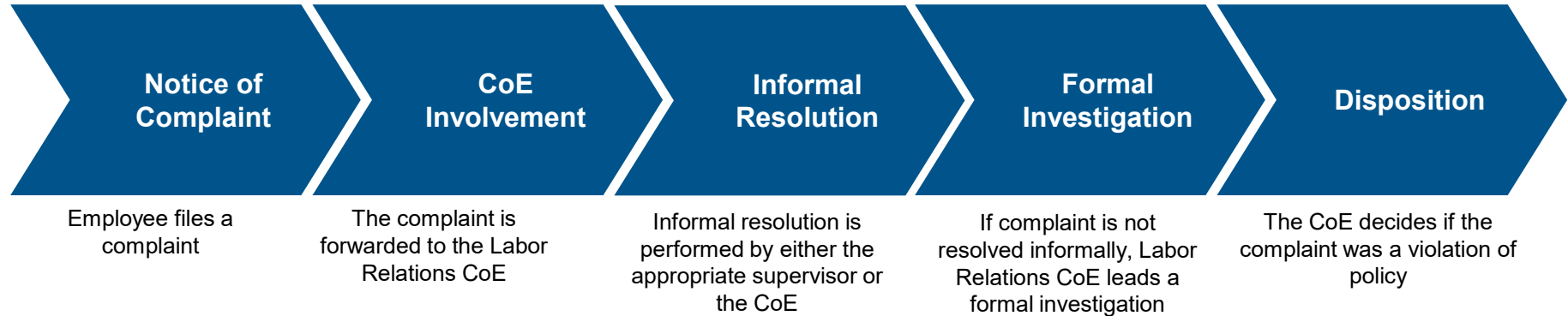

Roles	Responsibilities
<p>The CCSU Center of Excellence is comprised of five individuals that hold 3 distinct positions:</p> <ul style="list-style-type: none"> <li>▪ <b>Director</b> of Labor Relations</li> <li>▪ Labor Relations <b>Associate</b></li> <li>▪ Labor Relations <b>Regional Investigator</b> (3 total for each region)</li> </ul>	<ul style="list-style-type: none"> <li>▪ <b>Guidance and direction</b> on employee relationships</li> <li>▪ Ensure <b>compliance</b> with bargaining agreements</li> <li>▪ Workplace <b>Investigations</b></li> <li>▪ Developing and enforcing <b>workplace policies and procedures</b></li> <li>▪ <b>Conflict</b> solutions</li> <li>▪ <b>Grievance</b> resolution</li> </ul>

Source: <https://www.ct.edu/hr/labor-rel>

# Pennsylvania State University Shared Services



Penn State University is another example of an employee relations best practice. Their model has HR business partners within each campus that lean on shared services for employee relations support.

## Model Overview

- All 24 campuses within Penn State have a **HR Business Partner** who works to identify and triage employee-related issues
- The Labor and Employee Relations Shared Service Center provides support in:
  - **Risk assessment**
  - **Policy interpretation**
  - **Investigation Support**
  - **Liaison to counsel**
- This operating model is dependent on a **unified set of policies** and a **defined role/point of contact** for each campus

## Illustrative Model

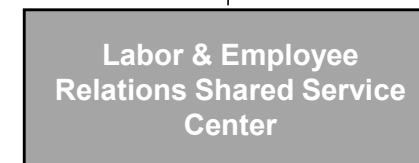
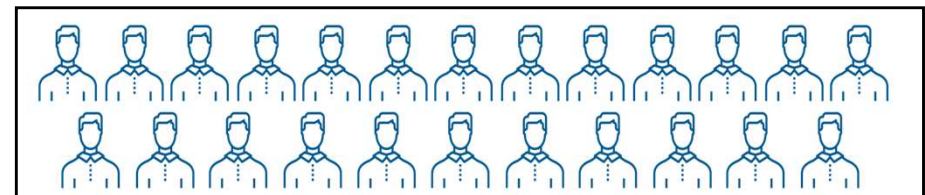

### Model Key



Source: <https://hr.psu.edu/employee-relations>

# Scenario Overview

The following two scenarios are coupled with illustrative models that depict the organizational design to be considered. Outlined below are keys that will be useful for understanding the models.

## Model Key

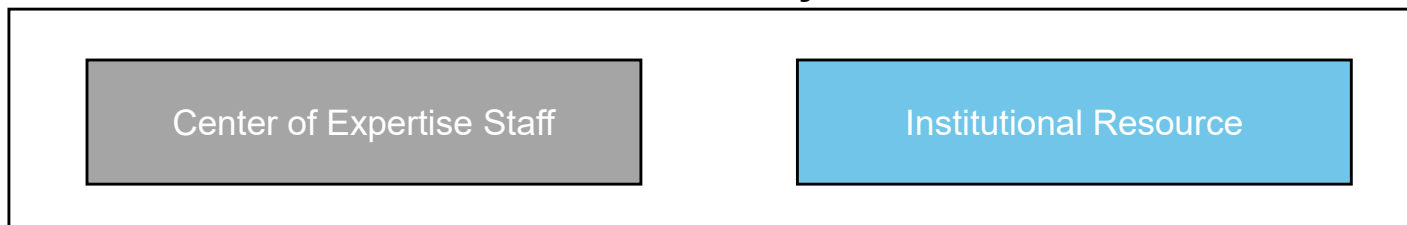

## Key Positions

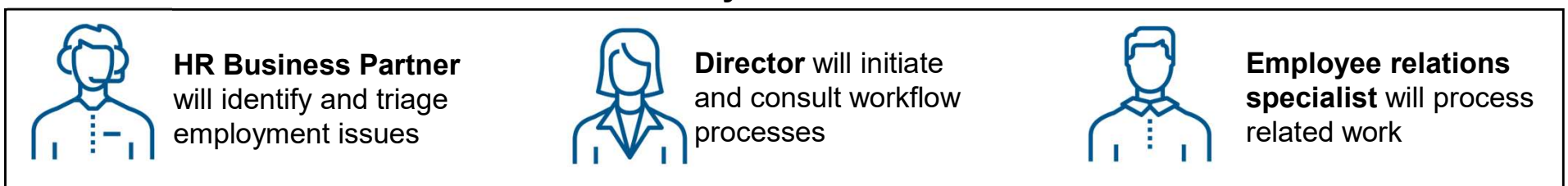

# Scenario 1: USHE Center of Expertise

The first future state scenario entails developing a central center of expertise that will act as a systemwide resource to support institutional HR leadership in employee relations matters.

## Scenario Overview

- Many USHE institutions do not have dedicated employee relations support. Implementing a systemwide center of expertise will **close resource gaps**, create **consistent policies and procedures**, and increase overall **employment law compliance**.
- The center of expertise will include:
  - One director who oversees and consults employee-related processes
  - Three employee relations specialists who process and support the required work, including **risk assessment, policy guidance, investigations, and communications with counsel**

Scenario 1	CoE Staff	Institutional Staff	Total
<b>FTE</b>	4.0	-	4.0
<b>Expenses<sup>1</sup></b>	\$260K	-	\$260K

Source: <sup>1</sup>Salaries averaged across the industry on HigherEdJobs  
 Note: Staffing models based off of peer best practices

## Illustrative Model

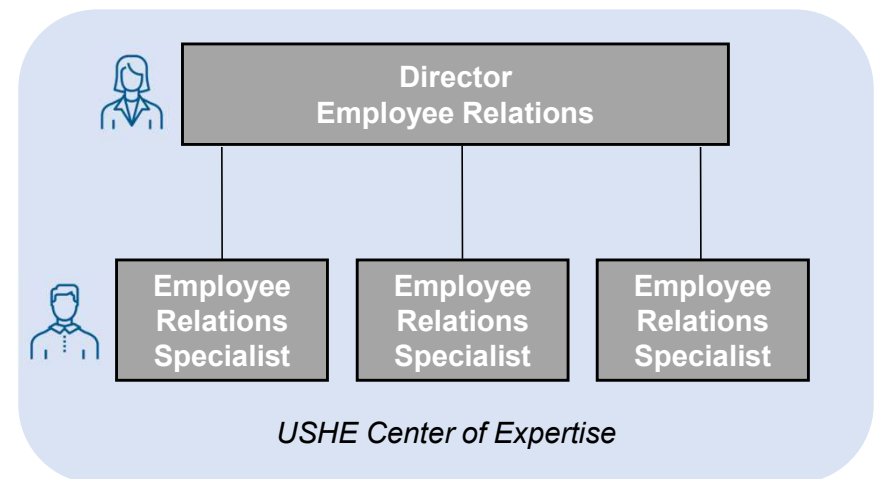



# Scenario 2: HR Business Partners & CoE

The second future state scenario involves implementing HR Business Partners that sit within the institutions in order to identify employment related issues and relay them to the center of expertise.

## Scenario Overview

- This organizational model assists in developing relationships between institutions and the center of expertise, which will ensure that all employment related issues are properly **identified and resolved**.
- Along with the center of expertise, this scenario includes **four HR Business Partners** (“HRBP”):
  - The HRBPs will act as an institution’s **main point of contact** for employee relations related matters
  - HRBPs can be distributed across the System based on **institutional size, institutional type, or geographic location**

Scenario 1	CoE Staff	Institutional Staff	Total
<b>FTE</b>	4.0	4.0	8.0
<b>Expenses<sup>1</sup></b>	\$260K	\$360K	\$620K

## Illustrative Model

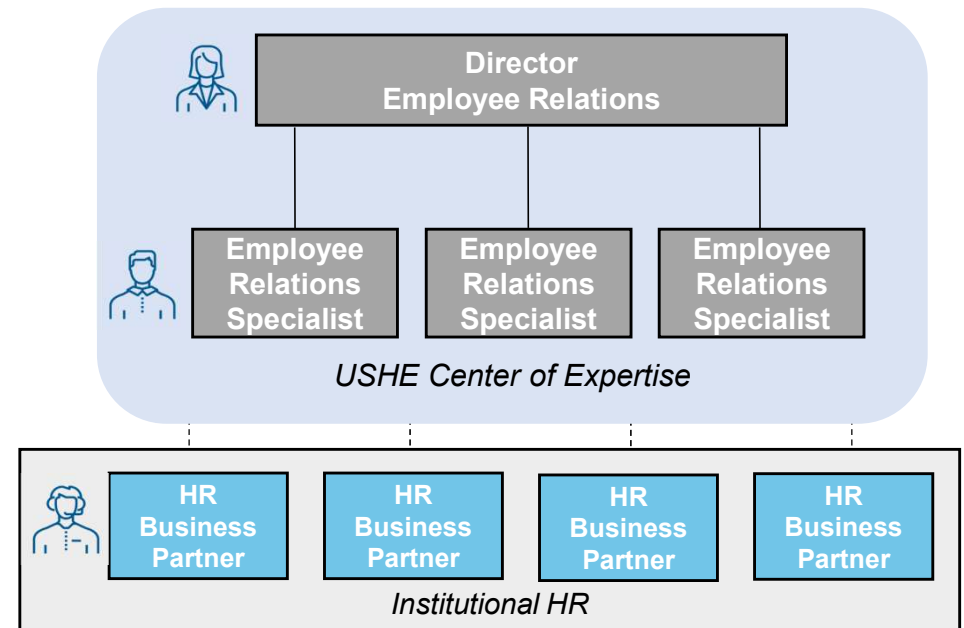

Source: <sup>1</sup>Salaries averaged across the industry on HigherEdJobs  
 Note: Staffing models based off of peer best practices

## Summary: Future State Scenarios

These future state scenarios represent options that USHE can move forward with as a means of increasing employment law compliance and supporting institutional employee relations efforts.

Scenarios	Cost	Benefits	Limitations
Scenario 1	\$260K	<ul style="list-style-type: none"> <li>▪ Little disruption to current operations due to optionality</li> <li>▪ Relatively inexpensive resource</li> </ul>	<ul style="list-style-type: none"> <li>▪ Lack of relationship development between CoE and institutions</li> <li>▪ Little institutional oversight can lead to possible non-compliance</li> </ul>
Scenario 2	\$620K	<ul style="list-style-type: none"> <li>▪ HRBPs develop relationship between institutions and CoE</li> <li>▪ Assurance of consistent practices due to institutional oversight</li> </ul>	<ul style="list-style-type: none"> <li>▪ Size of system means that HRBPs will be overseeing multiple institutions</li> <li>▪ Requires further stakeholder investment and effort to implement</li> </ul>

**Both scenarios will result in net savings due to cost avoidance related to potential litigious risks.**

# Employment Law Next Steps and Risk Management

Key next steps are establishing a more detailed understanding of tools and vision, assessing current policy and process alignment, and evaluating staffing approaches.

Phase	PLANNING	DESIGN	IMPLEMENTATION
Timeline	Months 0 - 4	Months 4 - 8	Months 8 - 12
Key Activities	<ul style="list-style-type: none"> <li>Identify current technologies and platforms to support collaborative case management</li> <li>Evaluate case volume and need, by campus</li> <li>Develop vision and charter for proposed center of expertise</li> </ul>	<ul style="list-style-type: none"> <li>Design organizational structure and establish reporting lines (potentially dual)</li> <li>Develop institution portfolios for distinct business partners (ex: regional)</li> <li>Redesign escalation pathways to route through CoE</li> </ul>	<ul style="list-style-type: none"> <li>Hire and onboard center staff, inclusive of contracted resources if applicable</li> <li>Develop and socialize training material, including institutional 'road shows'</li> <li>Update policies and procedures to align with new structure</li> </ul>
Key Risks	<p><b>Policy Alignment:</b> The Center's ability to successfully drive will be dependent on how standardized and consistent policies are applied.</p> <p><b>Technological Consistency:</b> A sophisticated center of expertise will leverage case management software to track and route appropriate cases, which may require alignment across multiple institutions.</p> <p><b>Governance:</b> A systemwide center will need to navigate issues of ownership and accountability across USHE.</p>		

# 9

---

## Talent Acquisition

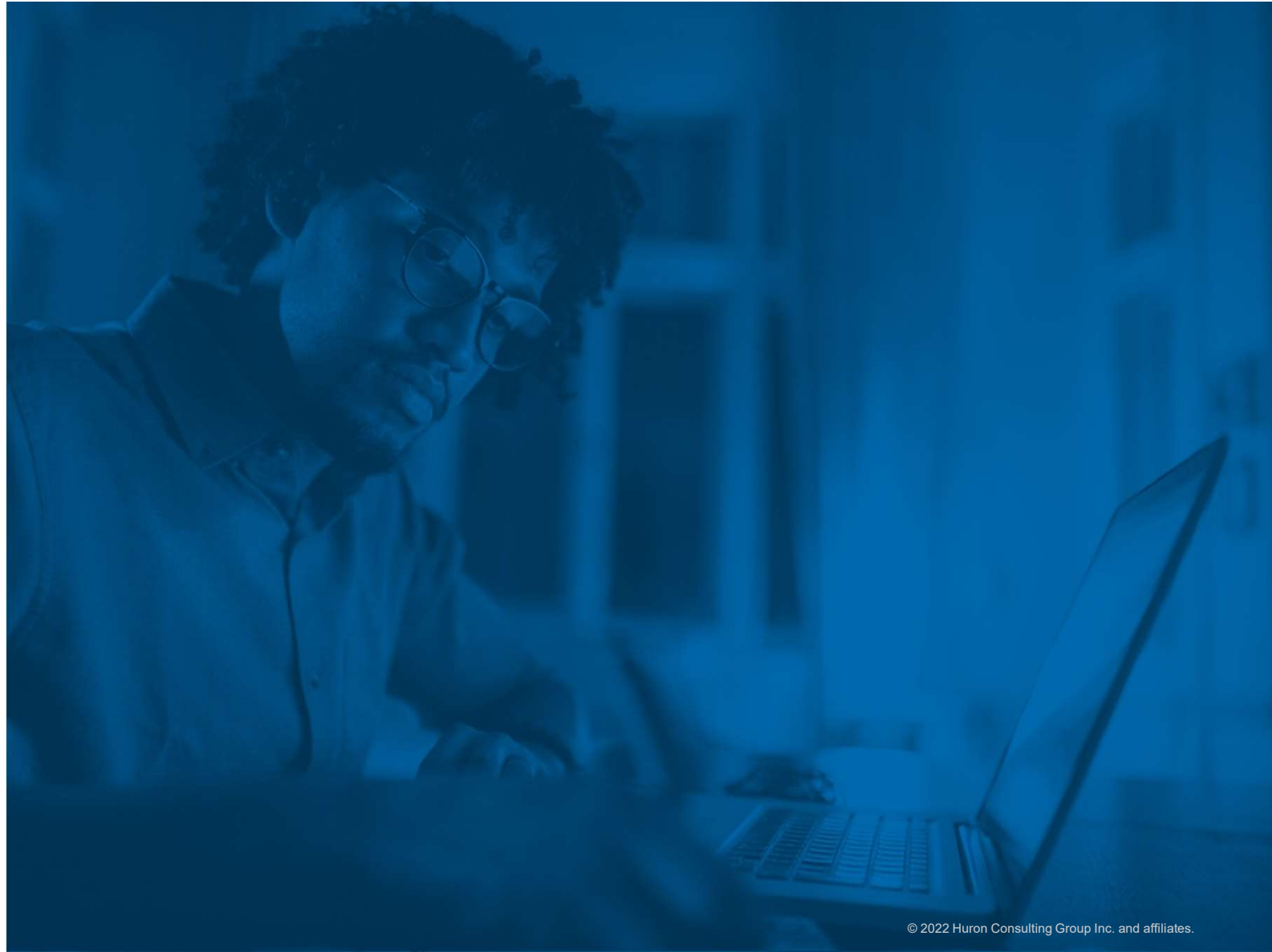

---

## Overview of Opportunity

USHE can improve talent acquisition with integrated business processes that facilitate retention and provide data for employee acquisition needs.

- USHE spends **\$4.94M** on talent acquisition services and dedicates **50.7 FTE** to the area
- Current talent management efforts are **highly distributed** with **68%** of activity occurring outside of the central unit
  - Fragmented activity can result in a lack of **strategic** talent acquisition and overall cohesion of recruitment efforts
- USHE does not have a resource or mechanism that allows the institutions to collaborate on talent acquisition efforts, which has led to a **loss of employees** from the System
  - Between the years 2019 and 2020, USHE lost almost **700 employees**
- Implementing a centralized model to support talent acquisition will combat industry trends through more **strategic employee recruitment and retainment efforts**

**The following slides provide an overview of talent acquisition, current USHE standings, industry best practices, and modeling of potential future state scenarios.**

# Talent Acquisition Services

Talent acquisition focuses on employee recruitment and retention. The key performance indicators and questions listed below emphasize fundamental elements of talent management services.

## Key Performance Indicators

- Time-to-hire
- Cost of filling the position
- Acceptance rate
- New employee retention rate
- New employee performance level
- Hiring manager's satisfaction with the recruitment process
- Applicants' perception of the recruitment process

## Strategy Development Questions

- *What type of individuals should be targeted?*
- *What recruitment message should be communicated?*
- *How can the targeted individuals best be reached?*
- *When should the recruitment campaign begin?*
- *How can we best retain our current employees?*

# Talent Acquisition Risks

Industry benchmarks have shown that the following categories are perceived as the top risks related to talent management.



## CAPABILITY

Risks associated with building the skills an institution needs to stay competitive within the growing market



## COST

Risks related to the financial cost of recruiting and retaining the people that an institution requires



## COMPLIANCE

Risks that revolve around ensuring that talent processes and management comply with local laws and regulations



## CAPACITY

Risks relating to career progression and the ability to retain essential people and teams within an institution



## CONNECTION

Risks that come with employees, particularly those in critical roles, becoming disengaged in their work

# Risk Exposure Consequences

Inadequate talent management can result in an underdeveloped and unproductive workforce, which creates inefficiencies throughout an institution and puts it at a disadvantage within the market.

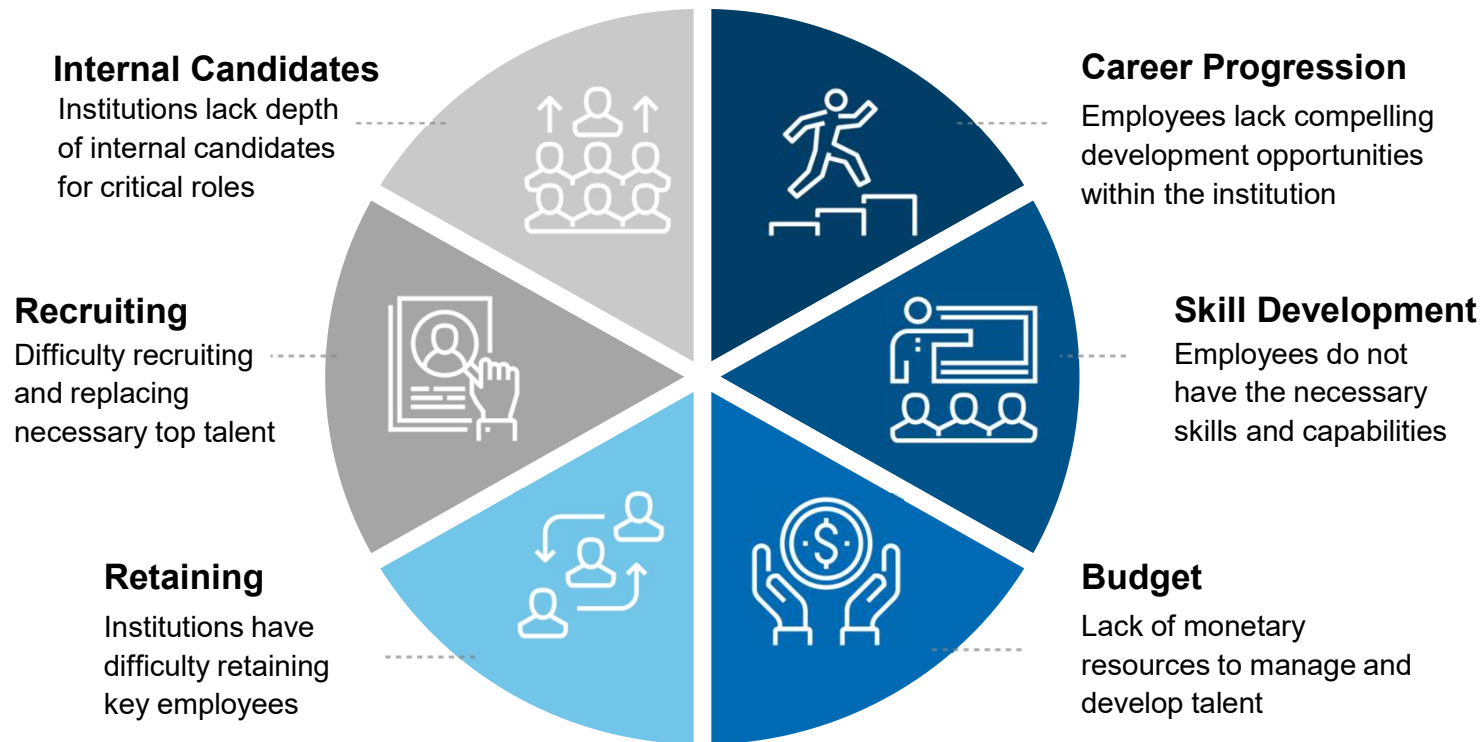



# Risk Avoidance Strategies

To combat the risks related to talent management, higher education institutions have increased their talent acquisition focus on key areas in order to attract and retain talent.



## Technology

Recruiting processes have been moved to a virtual environment to increase cost and time savings as well as bring clarity to talent data



## Remote Recruiting

Institutions have looked to hire across geographic borders as a way to increase the applicable talent pool



## Internal Talent

Industries have increased their learning and development budgets as a means to focus on internal hiring



## Diversity, Equity & Inclusion

Candidates have emphasized the importance of DE&I commitments to focus on institutional culture and reputation

# USHE Talent Acquisition Overview

USHE trends depict a systemwide loss of employees and unpredictable future trends emphasize the need for strategic talent management services.

- Conversations with stakeholders as well as quantitative data show that USHE has been impacted by the **industry trends of a waning workforce**
  - The majority of institutions have seen a **decrease in their employee count** from the years 2019-2020
  - Stakeholders noted that the System **lacks shared resources** for necessary talent management collaboration

**On average, it costs an organization 6-9 months of an employee's salary to replace them<sup>1</sup>. To avoid such expenses, systemwide talent acquisition services need to have a consistent and well-developed strategy.**

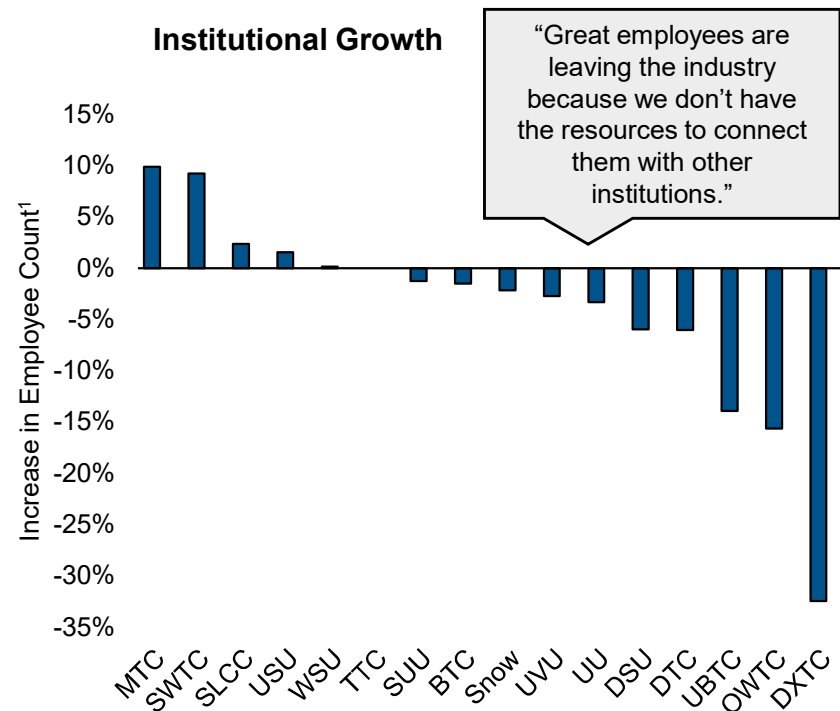

Source: <sup>1</sup>SHRM

# USHE Applicant Tracking Systems

Across USHE, institutions use a variety of application tracking systems which has led to difficulties in systemwide collaboration and recruitment efforts.

- Application tracking systems (“ATS”) across the System are inconsistent, with some institutions having **multiple systems** and others **not having a system** altogether
  - Conversations with stakeholders revealed that inconsistent and multiple applicant tracking systems has led to **manual and inefficient processes** for talent management practices

**Without a common application tracking system, institutions struggle to obtain consistent talent acquisition data, which decreases systemwide collaboration.**

**Institutional Applicant Tracking Systems<sup>1</sup>**

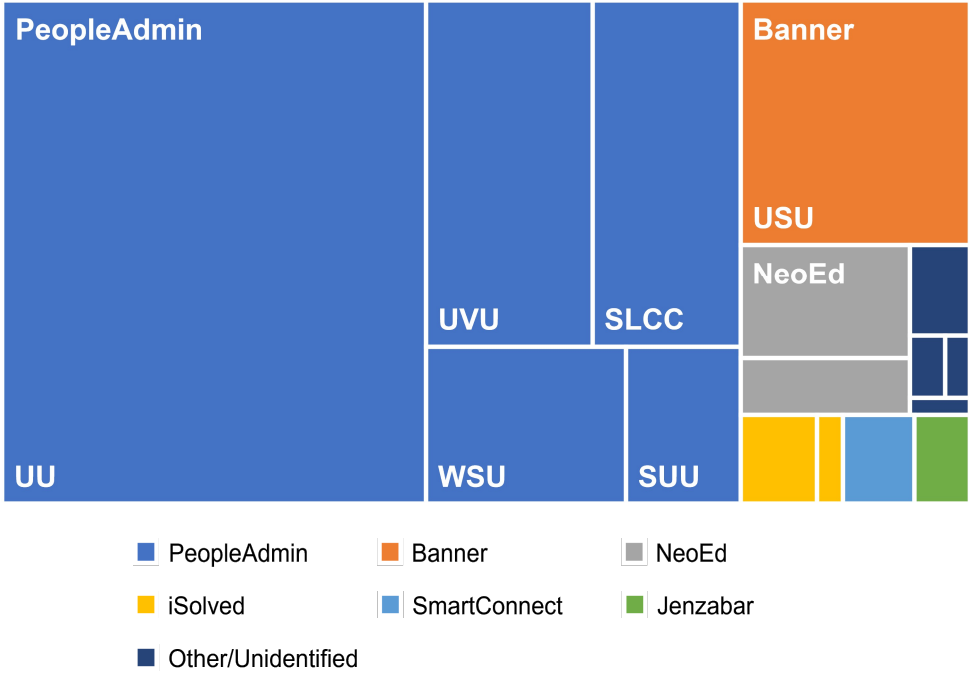

Source: <sup>1</sup>ATS inventory taken from institutional data received through the Study data request  
 Note: Size of leaf represents how many employees are in each institution.

# Case Study: UU Response to Industry Trends

Institutions within USHE have developed programs to combat the workforce trends within higher education. These programs target workplace flexibility as a means to attract and retain employees.

- **Overview:** UU has launched a pilot program focused on telecommuting called Work Reimagined. The program is set to run for 24 months during which it will be monitored for potential modifications
- **Rationale:** UU decided to run this program as a way to increase employee retention, improve employee job satisfaction, and attract new, remote employees
- **Prerequisites:** Each position is analyzed to determine whether job duties could be performed remotely. Employees that are telecommuting must uphold expectations, customer service, and responsiveness



**In developing a program that focuses on remote-work, UU can expand their geographic reach with the potential to better adapt to current employee needs, increase diversity, and attract new talent.**

Source: <https://workreimagined.utah.edu/>

# Case Study: USU Response to Industry Trends

Utah State University has developed a program targeting employees in varying geographic areas through the offering of courses centered on remote employment.

- The Rural Online Initiative (“ROI”) is a program that aims to provide Utah’s rural workforce with **education, training, and services** for remote employment
  - USU Extension has developed the program, demonstrating its **commitment to remote work**
  - ROI aims to **empower rural communities** and in turn increase the number of capable remote workers.
- After its start in 2018, the Utah State Legislature has removed the sunset of ROI, which depicts its success and the **future of remote work**









**Programs that focus on future workforce trends, such as remote work, increase the diversity of potential candidates and emphasize the importance of flexibility in talent management.**

Source: [https://extension.usu.edu/news\\_sections/impacts/roi](https://extension.usu.edu/news_sections/impacts/roi)

## Examples in Higher Education

Institutions and state systems have implemented various talent acquisition services to support the recruitment and retainment of employees.

Seal	Institution Name	Services Description
	California Community Colleges	The CCC has a user-friendly common registry that acts as a large-scale database for individuals seeking a job at one of the colleges.
	University of Oregon	The University established a single central website for job openings throughout neighboring institutions for applicants looking for employment in a certain area.
	University System of Wisconsin	System HR has a search and screen committee that analyzes the talent pool and conducts phone interviews to support the assemblage of qualified candidates.
	Connecticut State Colleges and Universities	CSCU developed a center of expertise made up of five employees that supports recruitment processes to align talent initiatives to DE&I and strategic goals.
	Princeton University	Princeton implemented an ATS that includes search capabilities for employers, as well as a talent network that allows candidates to get job updates.
	University of Chicago	The University has a center of expertise that coordinates and supports workforce planning, strategic sourcing, talent pool assessment, and selection.

# Scenario 1: Common Application Tracking System

The first future state scenario entails implementing a common application tracking system across USHE that is easy to navigate for candidates and institutional recruitment staff.

## Scenario Overview

- Currently, USHE lacks a shared common recruitment resource. A common application tracking system will produce **consistent recruitment data**, which will increase **collaboration** and **communication** across USHE institutions
  - Consistent recruitment data will allow institutions to better **track applicant trends**
  - Applicants will be able to view and apply for jobs across the System which helps to **decrease geographic restrictions**

Scenario 1	Applicant Tracking System
Expenses <sup>1</sup>	\$25K-\$150K

## Applicant Tracking System Services

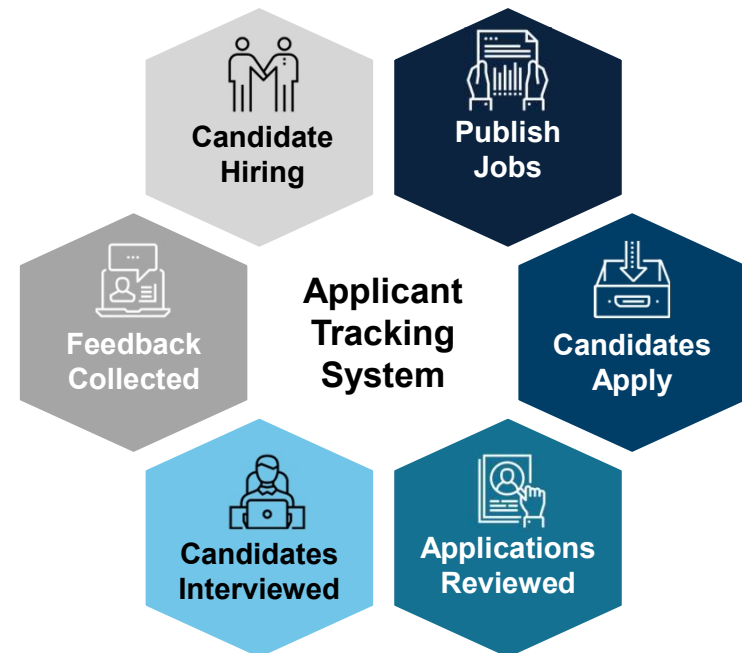

Note: <sup>1</sup>Expenses represent a mixed estimate range based on recurring annual fees and varying potential ATS pricing models. This estimate does not include the one-time implementation fee.

# Scenario 2: Tier 1 Support

The second future state scenario entails implementing tier 1 support along with a common application tracking system to ensure quality service delivery and efficient responsiveness.

## Scenario Overview

- Combining tier 1 support with a shared application tracking system will enhance the recruitment experience for both **applicants** and **employees**
  - Applicants will have a **defined point of contact** that they can reach out to with questions related to the functionality of the applicant tracking system
  - Employees can rely on tier 1 support for applicant tracking system-related inquiries such as, **job posting, candidate feedback, and recruitment data collection**

Scenario 2	ATS	Tier 1 Staff	Total
FTE	-	4.0	4.0
Expenses <sup>1</sup>	\$88K	\$160K	\$248K

Source: <sup>1</sup>HigherEd Jobs

Note(s): Tier 1 staffing based off of industry best practices and internal benchmarks; Average of pricing range used for ATS cost analysis

## Illustrative Model

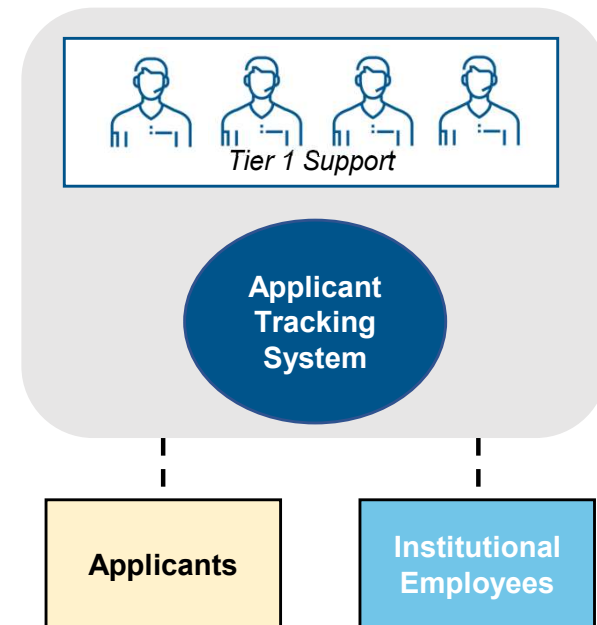



# Scenario 3: Talent Acquisition Center of Expertise

The third future state scenario entails implementing a fully functioning center of expertise that oversees and consults on all talent acquisition matters for the System.

Scenario Overview		Illustrative Model	
<ul style="list-style-type: none"> <li>The center of expertise <b>oversees, processes, and supports</b> all talent acquisition practices and procedures, including:                             <ul style="list-style-type: none"> <li><b>Workforce planning:</b> Proactively identify talent needs and build candidate pipeline</li> <li><b>Strategic sourcing:</b> Offer targeted hiring support</li> <li><b>Talent pool assessment:</b> Leverage critical selection factors for candidate evaluation</li> <li><b>Successful selection:</b> Create a well-supported candidate experience</li> </ul> </li> </ul>		<p style="text-align: center;"><i>USHE Center of Expertise</i></p>	
		<p style="text-align: center;"><b>Applicant Tracking System</b></p>	
<b>Scenario 3</b>	<b>ATS</b>	<b>Center of Expertise Staff</b>	<b>Total</b>
<b>FTE</b>	-	5.0	4.0
<b>Expenses<sup>1</sup></b>	\$88K	\$253K	\$341K

Source: <sup>1</sup>HigherEd Jobs

Note(s): Center of Expertise staffing based off of industry best practices and internal benchmarks; Average of pricing range used for ATS cost analysis

## Summary: Future State Scenarios

The presented scenarios represent opportunities for USHE to improve their talent acquisition strategies through more focused employee recruitment and retainment.

Scenarios	Cost	Benefits	Limitations
Scenario 1	\$88K	<ul style="list-style-type: none"> <li>Consistent systemwide recruitment data</li> <li>Increase in accurate metrics for diversity, equity, and inclusion efforts</li> </ul>	<ul style="list-style-type: none"> <li>Varying recruitment processes within the institutions will make initial implementation difficult</li> </ul>
Scenario 2	\$248K	<ul style="list-style-type: none"> <li>Enhanced candidate experience</li> <li>Extra support will increase employee understanding of the tool's capabilities</li> </ul>	<ul style="list-style-type: none"> <li>Lack of strategic recruitment and retainment processes</li> <li>Little to no systemwide collaboration</li> </ul>
Scenario 3	\$341K	<ul style="list-style-type: none"> <li>Strategic recruitment processes will keep USHE competitive within the market</li> <li>Increased capacity for institutional employees</li> </ul>	<ul style="list-style-type: none"> <li>Varying school missions requires multiple methods of strategic recruitment</li> <li>Decrease in institutional control</li> </ul>

**These scenarios will increase net savings through cost avoidance related to employment, including a decrease in systemwide employee turnover and replacement costs.**

Note: Average of pricing range used for ATS cost analysis

# Talent & Acquisition Next Steps and Risk Management

Key next steps are establishing technological integration across USHE systems, engaging key recruitment stakeholders, and evaluating vendors.

Phase	PLANNING	DESIGN	IMPLEMENTATION
Timeline	Months 0 - 3	Months 3 - 6	Months 6 - 12
Key Activities	<ul style="list-style-type: none"> <li>Inventory and evaluate technological requirements to bridge USHE systems</li> <li>Develop an RFX and solicit vendor bids for ATS (as appropriate).</li> <li>Engage recruitment leads in visioning and goal development</li> </ul>	<ul style="list-style-type: none"> <li>Review vendor quotes and identify desired partner</li> <li>Begin ATS integration and design process</li> <li>Begin staffing and onboarding process for CoE Director</li> </ul>	<ul style="list-style-type: none"> <li>Implement ATS system and engage with core stakeholders</li> <li>Begin staffing and onboarding process for CoE Specialists</li> <li>Publicize revised processes and policies and drive adoption</li> </ul>
Key Risks	<p><b>Technological Consistency:</b> USHE has a wide range of ATS platforms, and it will require a significant effort to drive change towards a more standardized experience.</p> <p><b>Culture:</b> Collaboration and information sharing around requirement is often a sensitive topic and will be an obstacle in implementation.</p> <p><b>Process Redesign:</b> Recruitment is decentralized in some institutions and significant process redesign is necessary to integrate the new CoE</p>		



 **HURON**